

24" Surface Cleaner

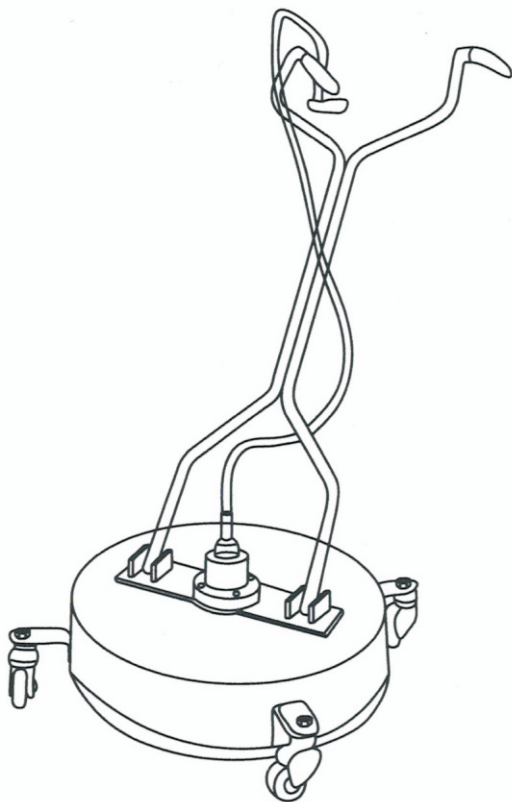

OPERATING INSTRUCTION

Pressure Washer Surface Cleaner

24-inch Stainless Steel Surface Cleaner for pressure washer is designed to clean large surface. This flat-surface cleaner features dual-handle with trigger gun. The cleaner can be used on horizontal surfaces including decks, patios, sidewalks, driveways, pool decks, etc.

Dual High-Pressure Rotating Jets

For a thorough clean that is fast and streak free. The jets spin when they're under high pressure, removing dirt and grime from surfaces with ease. Cleans up to 5 X FASTER than a standard spray nozzle.

Dome Housing Design Controls Overspray

Stainless steel housing-good corrosion-resistance, designed for bad circumstances. The power of the high-pressure water jets is contained inside of the dome enclosure to concentrate all of the cleaning on the surface at hand with no overspray or backsplash.

Convenient operation

Heavy Duty Stainless steel housing with compact design & light aluminum handle & Four universal wheels.

24" Surface Cleaner



WARNING:

To reduce the risk of injury, user must read and understand the operator's manual for their pressure washer before using this accessory. Fits most pressure washers. Ensure compatibility and proper fit before using this accessory. Wear eye protection marked to comply with Z87. 1. Risk of fluid injections. Do not point at people, pets, electrical devices or the unit itself. Turn off the pressure washer before changing or adjusting accessories. For cold water use only. Save these instructions. Refer to them frequently and use them to instruct other users. If you loan someone this tool, loan them these instructions also.

TECHNICAL SPECIFICATIONS

Connection	3/8 inch Quick Connect Plug
Diameter	24-inch
Max Pressure	4,500 psi
Working Pressure	3,700 psi
Min Pressure	2,000 psi
Max Water Flow	6.6 GPM
Max Water Temperature	158°F
Weight	30.8 lbs
Nozzles	2

ASSEMBLING THE SURFACE CLEANER

See Figure 1-4.

- Place the legs of the lower handle in the mounting brackets on the surface cleaner deck. Align the holes in the legs with the holes in the brackets.
- Insert pin through the holes in the mounting brackets and legs. Install split ring through hole on the end of the pin to secure.
- Repeat this process to secure the other leg.
- Attach the upper handle to the lower handle. Secure with pin and split ring.

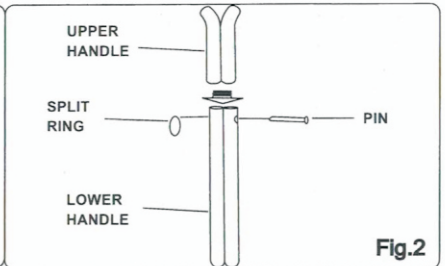
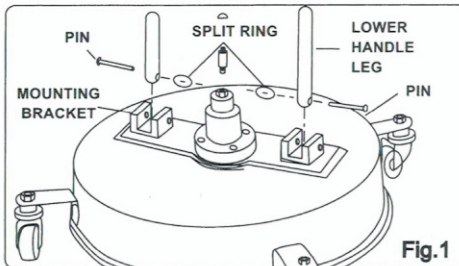

- Apply high strength threadlocker liquid or teflon tape (if needed) to the ends of the hose.
- Attach the fixed end of the hose to the trigger handle inlet. Securely tighten, but do not overtighten.
- Attach the swivel end of the hose to the inlet on the top of the surface cleaning deck. Securely tighten, but do not overtighten.
- Check the bottom of the surface cleaner deck to verify that the nozzles are tightened securely and are aligned correctly.

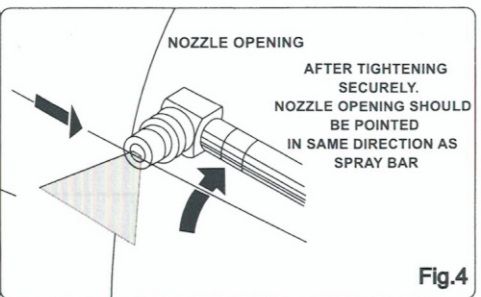
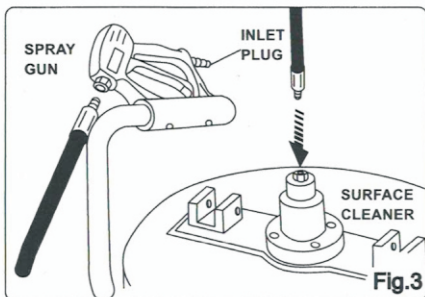

USING THE SURFACE CLEANER

See Figure 5.

* Attach the high pressure hose of your pressure washer to the inlet plug on the surface cleaner's spray gun.

* Connect the garden hose to your pressure washer and start the pressure washer as described in your pressure washer manual.

* Walk slowly behind the cleaning deck, cleaning as you go.

NOTE: If striping or swirling occurs, slow your pace. If striping or swirling continues, the surface cleaner skirt bristles may be worn and in need of replacement.

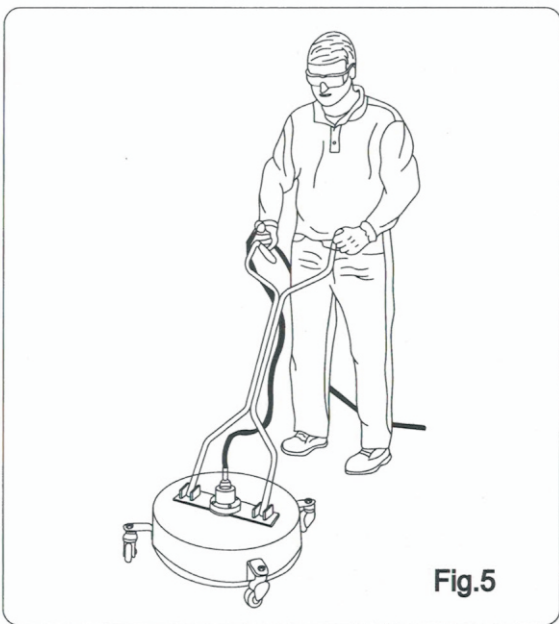

CAUTION:

Striking any raised obstacle while using the surface cleaner will damage the unit. If contact does occur and causes vibration when operating the pressure washer, stop and replace the spray bar. Continuing to operate the unit without replacing the spray bar could result in serious injury or damage to the unit.

NOTE: See figure 6 for the location of the spray bar.

NOZZLE MAINTENANCE

See Figure 6.

Excessive pump pressure (a pulsing sensation felt while squeezing the trigger) may be the result of a clogged or dirty nozzle

- * Turn off the pressure washer and shut off the water supply. With the surface cleaner on the ground, pull trigger to release water pressure.
- * Disconnect surface cleaner from high pressure hose.
- * Using a wrench (not provided), remove the nozzle from the spray bar.

NOTE: Never point the spray bar at your face.

- * Using a straightened paper clip or nozzle cleaning tool (provided), free any foreign materials clogging or restricting the nozzle.
- * Using a garden hose, flush debris out of nozzle by back flushing (running the water through the nozzle backwards or from the outside to the inside).
- * Reconnect the nozzle to the spray bar and tighten securely. After tightening, make sure the nozzle opening is pointed in the same direction as the spray bar as shown in figure 4.
- * Reconnect the high pressure hose to the spray wand.
- * Turn on the water supply and start the pressure washer.

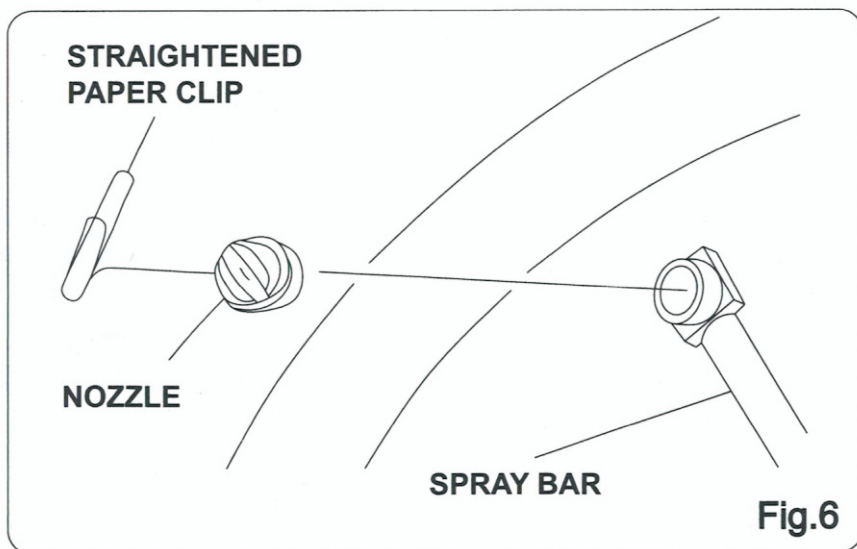

We'd love to hear from you

Thank you for your recent purchase of our product. We hope you will be pleased with both the product and service you received. If not, please give our helpful customer service team an opportunity to improve your experience right away; our team members are more than happy to help.

We can provide you with more kinds of pressure washer accessories, maybe you need: power washer, gun kit, sewer jetter kit, nozzles, surface cleaner, telescoping wand kit.



