

Contents

I .Precautions.....	2
II. Introduction for main parts.....	3-5
III. Technical parameters.....	6-7
IV. Bracket assembly diagram.....	8-10
V. Control buttons description and operation instructions.....	11
VI. Blade assembly.....	12-13
VII. Software and driver installation.....	14-19
VIII. Connection of software and machine.....	20-24

I .Precautions

1. Protective material must be removed before turning on the cutting plotter.
2. Check the label on the back side of the plotter to confirm that the rated voltage required by the plotter matches the voltage of the power base.
3. Firstly make sure that the power switch is off, then plug the power supply into grounded power outlet.
4. Please do not touch the power cord with wet hands to avoid electric shock.
5. Please only use the power cord, data cable provided with this product, or manufacturer-approved replacements.
6. Please do not drop metal objects and liquids into the machine to avoid malfunction.
7. After shutting down, you must wait another 5 seconds to turn on the cutting plotter again, otherwise it will cause damage to the cutting plotter.
8. In thunderstorms, turn the power switch to OFF and unplug the power cord.
9. Please do not privately change the manufacturer's components.
10. Manufacturer reserves the right to change product specifications without prior notice.
11. The manufacturer only bears the legal obligations of the product itself sold to the users, and does not bear other losses caused by the malfunction of the products.
12. Without our company's permit, no part of this manual can be copied or transmitted in any name.

II. Introduction for main parts

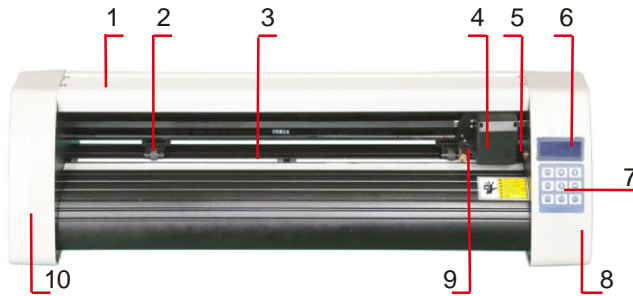

KH Model

1.Cover for rail guide	2. Pinch roller kit
3. Roller for feeding paper	4. Carriage
5. Reset switch	6. Screen
7. Buttons	8. The right cover
9. Blade clamp	10. The left cover

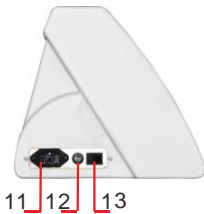

Left side

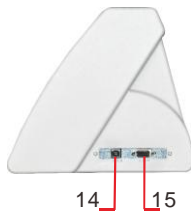

Right side

11.Power connection
12.Fuse holder
13.Power switch
14.USB port
15.COM port

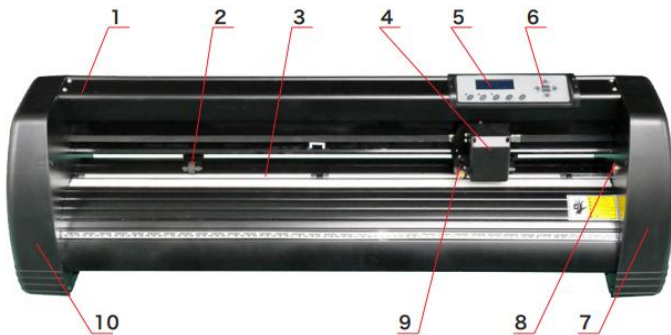

KI Model

1.Cover for rail guide	2. Pinch roller kit
3. Roller for feeding paper	4. Carriage
5. Screen	6. Buttons
7. The right cover	8. Reset switch
9. Blade clamp	10. The left cover



Left side



Right side

11.Power connection
12.Fuse holder
13.Power switch
14.USB port
15.COM port

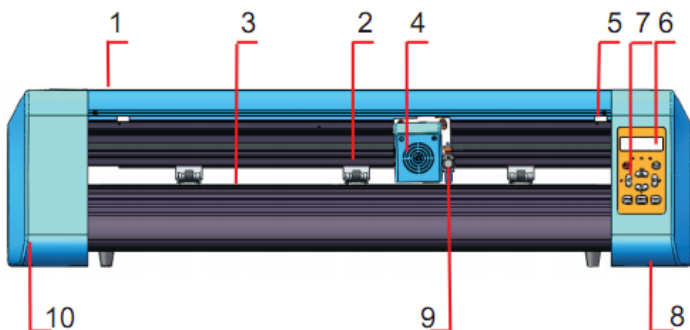

EH Model

1. Cover for rail guide	2. Pinch roller kit
3. Roller for feeding paper	4. Carriage
5. Reset switch	6. Screen
7. Buttons	8. The right cover
9. Blade clamp	10. The left cover

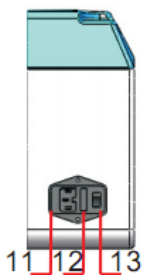

Left side



Right side

11. Power connection
12. Fuse holder
13. Power switch
14. USB port
15. COM port
16. U-disk port

III. Technical parameters

Item \ Model	375	720	870	1350
Max. feeding width	375mm	720mm	870mm	1350mm
Max. cutting width	285mm	630mm	780mm	1260mm
Cutting thickness	≤1mm			
Speed/Pressure	20-1200mm/s 20-1000g			
Buffer	1-4M			
LCD display	CN/EN			
Real-time Speed adjusting	Support			
Interface	COM+USB / COM+USB+U-DISK			
Re-cutting function	Support			
Re-cutting accuracy	0.127mm			
Resolution Ratio	0.0245mm/step			
Language format	DMPL/HPGL			
Voltage	AC85-264V			

Accessory box

	Item	Quantity	Unit
1	Cutting plotter	1	Set
2	Power supply cable	1	Pc
3	Blade	1	Box
4	Blade holder	1	Pc
5	Pen holder	1	Pc
6	Ball pen core	1	Pc
7	COM connection cable	1	Pc
8	USB cable	1	Pc
9	Spanner	1	Pc
10	USB driver	1	Pc
11	Bracket screws	1	Bag
To protect the machine, use only the accessories in this accessory box			

IV. Bracket assembly diagram

Iron bracket assembly diagram

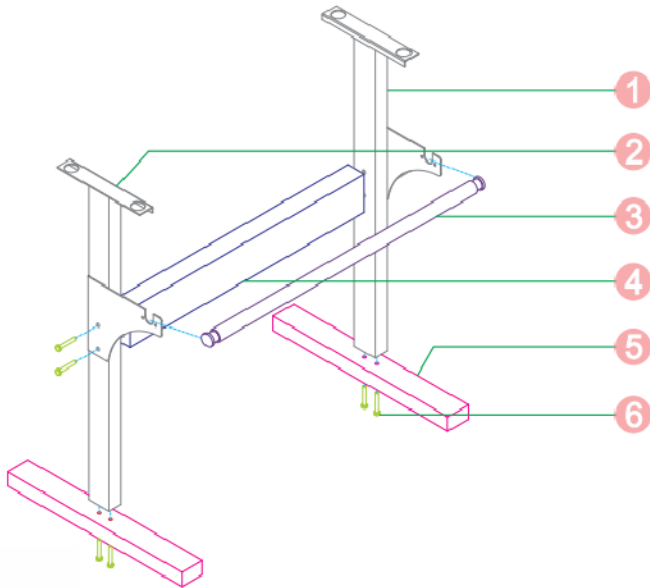

- | | |
|--------------------|------|
| 1. Right column | 1pc |
| 2. Left column | 1pc |
| 3. Paper roller | 1pc |
| 4. Beam | 1pc |
| 5. Foot | 2pcs |
| 6. M6*40 Hex bolts | 8pcs |

AI bracket assembly diagram

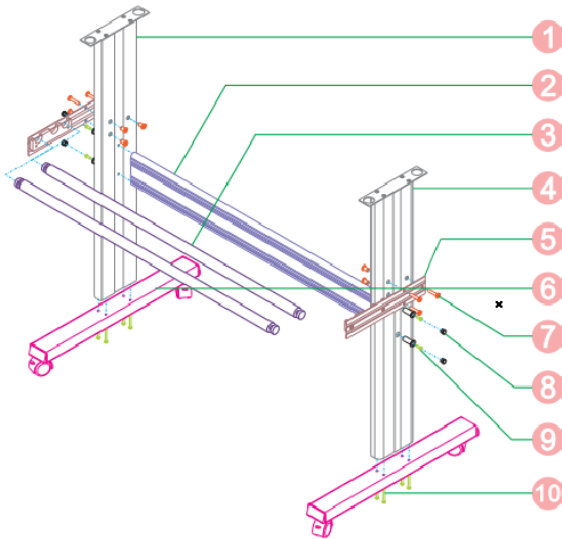

1. Left column	1pc
2. Beam	1pc
3. Paper roller	2pcs
4. Right column	1pc
5. Paper holder	2pcs
6. Foot	2pcs
7. Screws	6 sets
8. Screw sleeve	4 sets
9. Self-tapping screw 4*16	4pcs
10. Self-tapping screw 4*40	8pcs

Sheet metal racket assembly diagram

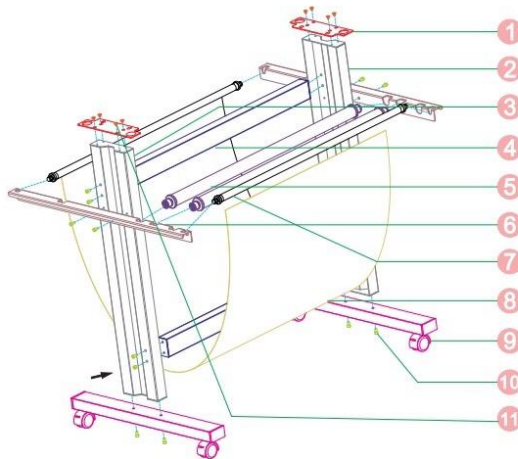

1. Connected board	2pcs
2. Right column	1pc
3. Left column	1pc
4. Beam	2pcs
5. Paper roller	2pcs
6. Paper holder	2pcs
7. Basket roller	2pcs
8. Basket	1pc
9. Foot	2pcs
10. 5×10 Socket head cap screw	20pcs
11. 4×6 Flat head screw	8pcs

V. Control buttons description and operation instructions

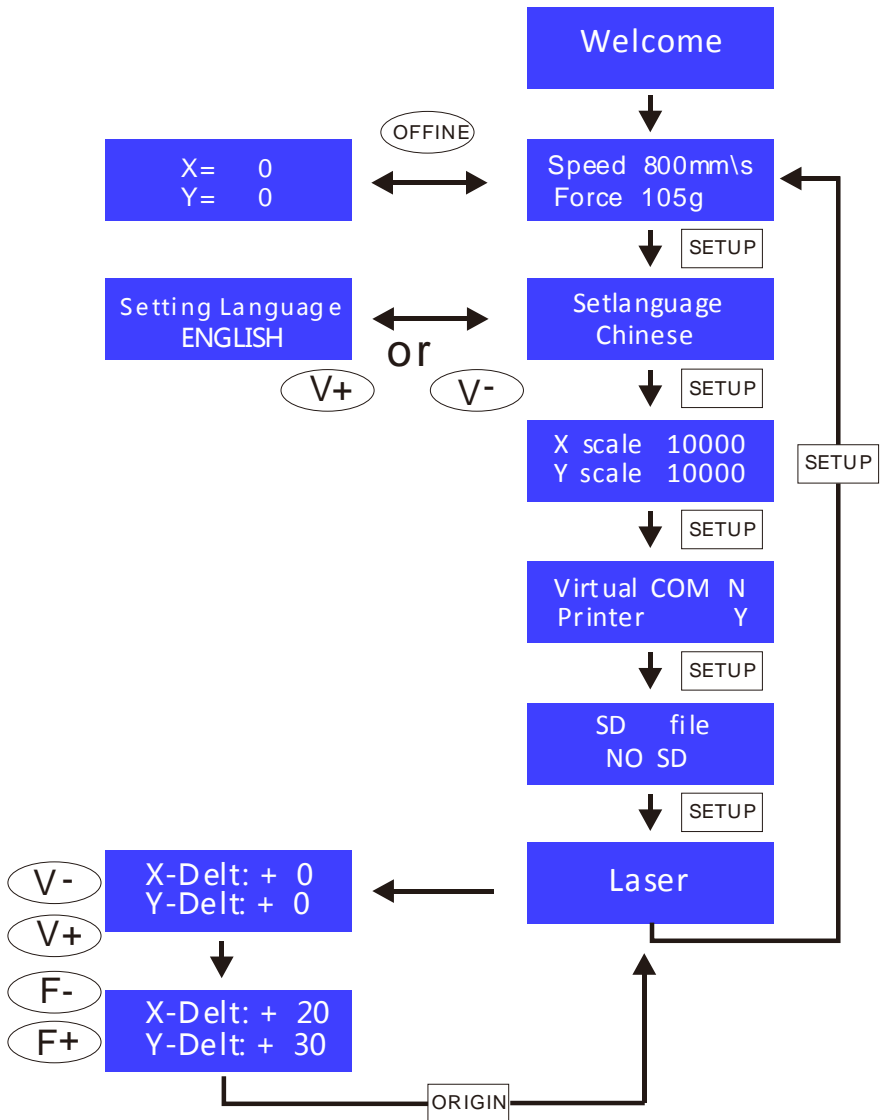

VI. Blade assembly

1). Assembly the blade into holder, see as below:

(Appearance view)

(Exploded view)

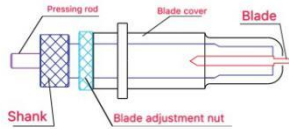
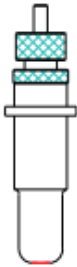

2). Loosen the blade adjustment nut and rotate the shank to adjust the length of the exposed blade tip. Determine the tip length according to the thickness of the material.

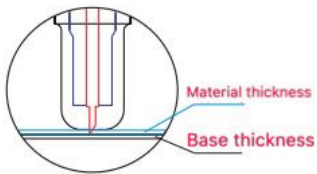

Correct

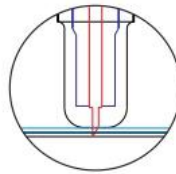

Blade tip is too long

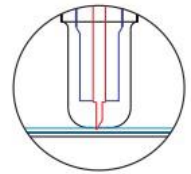

Blade tip is too short

- 1) Press the pressing rod when you want to change blade. Take out the blade when it is exposed.
- 2) Assembly the blade holder into wagon:
 - a, Loosen the fixed screw on tool holder
 - b, Put the blade holder into tool holder
 - c, Tighten and fix the blade holder when it arrives to correct position



Tips:

Do not touch the blade tip by finger, otherwise, your finger will be injured and the tip will be blunt.

VII. Software and driver installation

1. Open the software box (pic 1), take the disk and put it into CD optical drive (pic 2)



(pic 1)



(pic 2)

2. Open the computer, double click or right click optical drive to install the software. (pic 3)

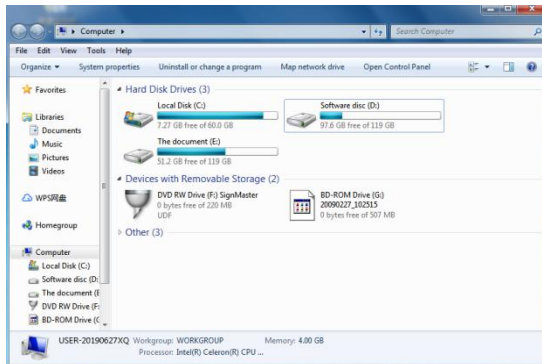

(pic 3)

3. After opening optical drive, click Install Software (pic 4)

Click on the icon in the red box

Select the language



(pic 4-1)

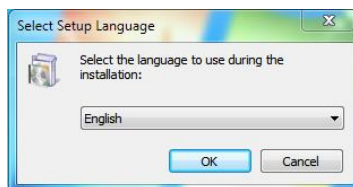

(pic 4-2)



Enter the PSN code

Agreeto click next

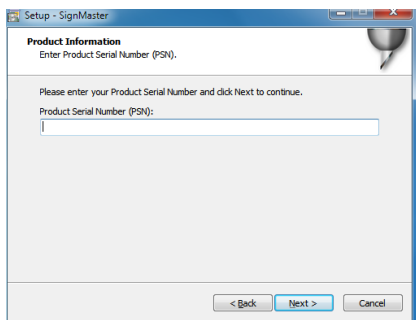

(pic 4-3)

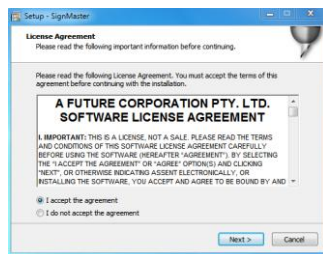

(pic 4-4)

PSN code can be found at left side of opened software box.

Default installation path, click next

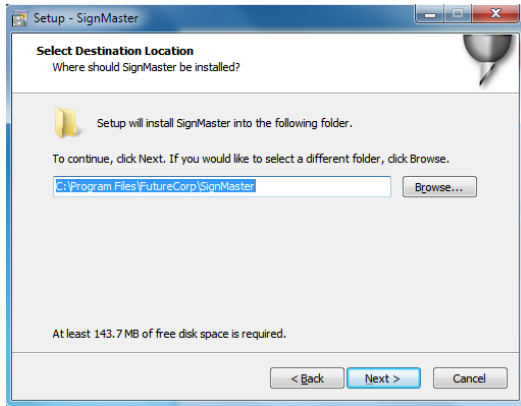

(pic 4-5)



Select the unit

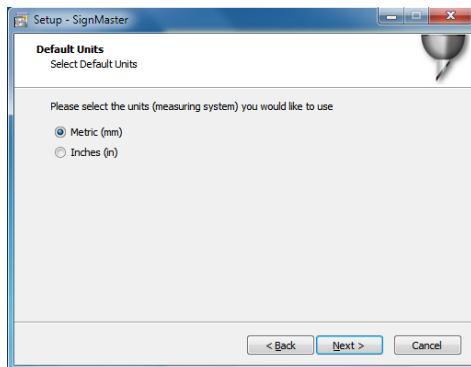

(pic 4-6)



Select machine model

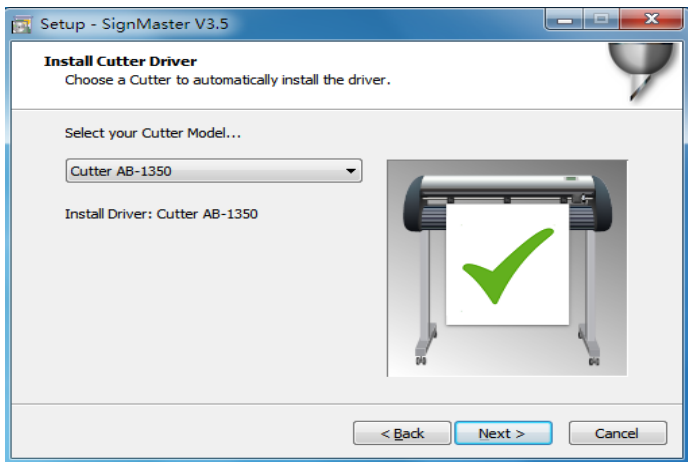

(pic 4-7)

(
(pic 4-7)



Next

The selected machine model can be viewed in the label above the machine power socket

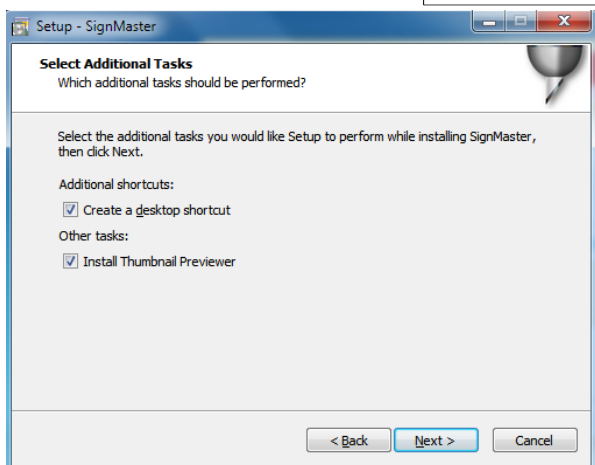

(pic 4-8)



The installation is complete

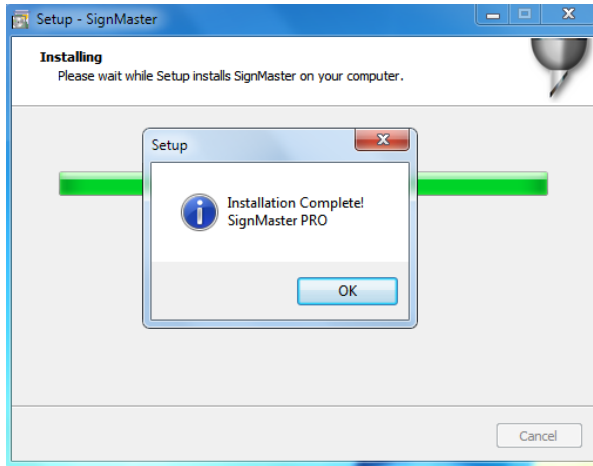

(pic 4-9)

This activation window appears when you open the software

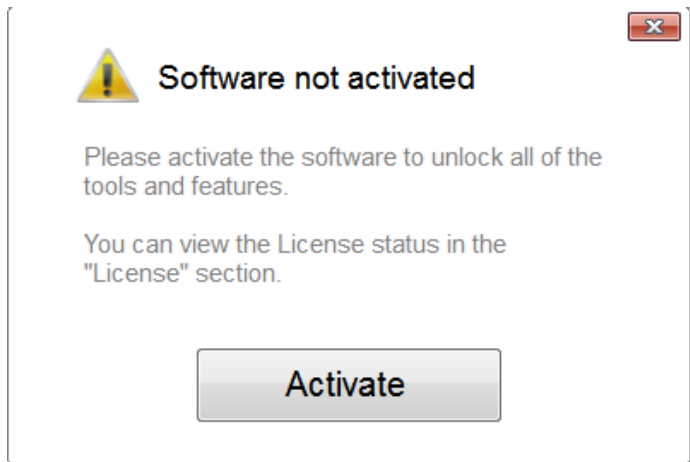

(pic 4-10)

Click activate and enter your email twice

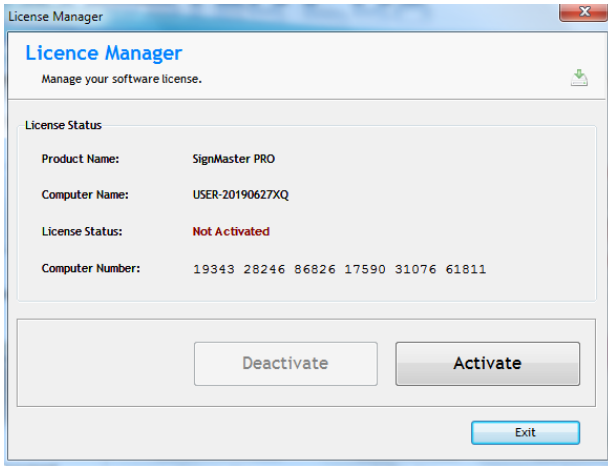

(pic 4-11)

Activation successful, exit

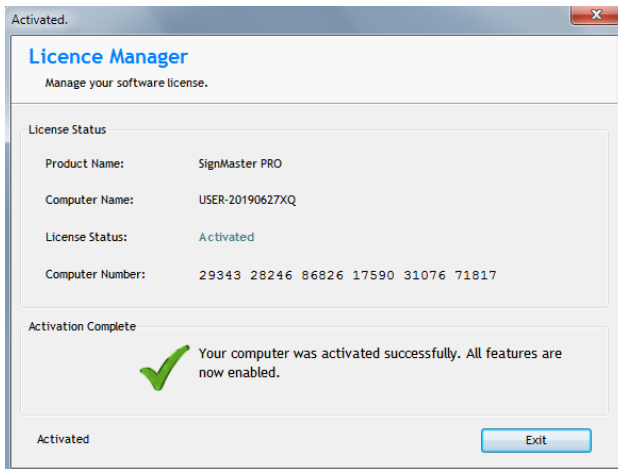

(pic 4-12)

VIII. Connection of software and machine

1. Open the software, select cut content, and click send to the cutting plotter

Click the carving knife icon in the red box

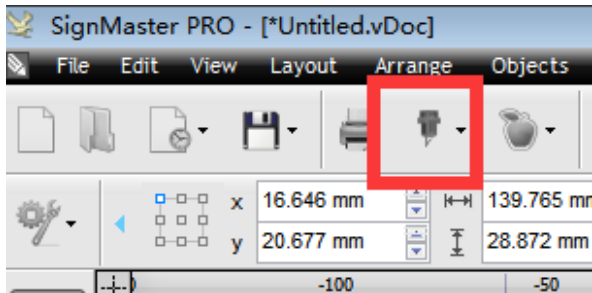

(pic 5-1)



Click send to cutting plotter

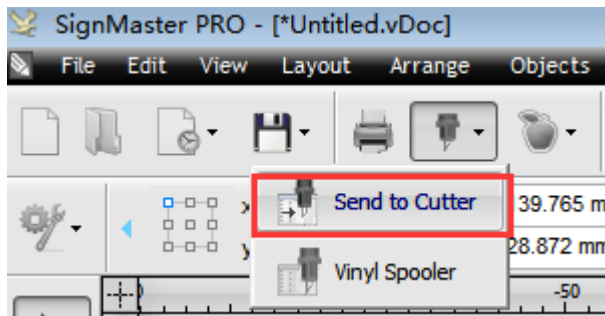

(pic 5-2)



Click properties

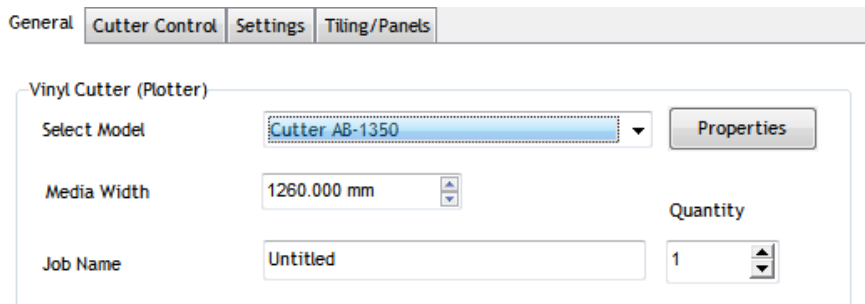

(pic 5-3)



Click connect

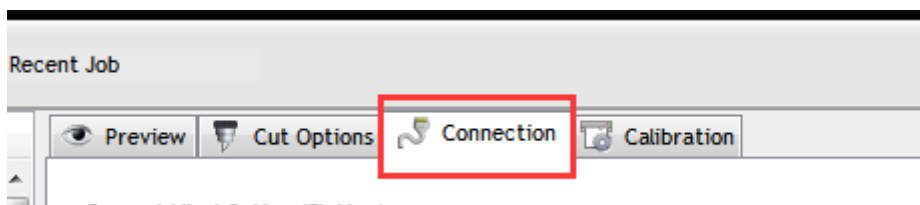

(pic 5-4)



Select machine model

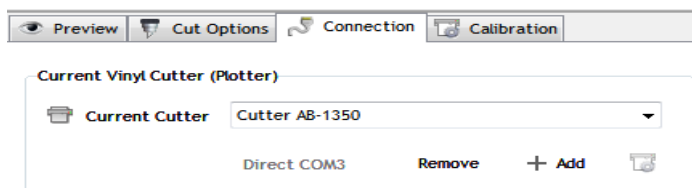



(pic 5-5)



Select Direct USB Port

Connection Method



Port Type  Direct USB Port ▼  Help

(pic 5-6)



Drop-down select driver

Settings

 USB Port  ▼

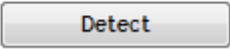
Status Device Connected 

(pic 5-7)



Click finish

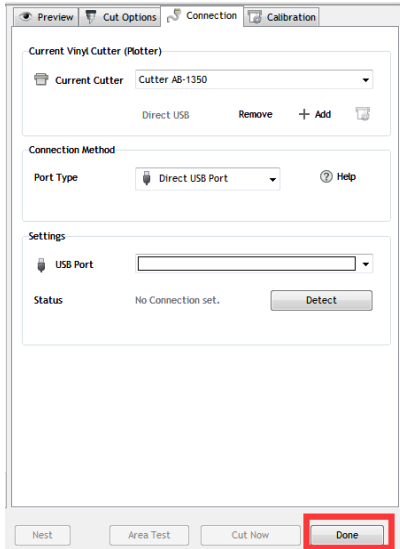

(pic 5-8)

Click cut now



(pic 5-9)

Click cut now

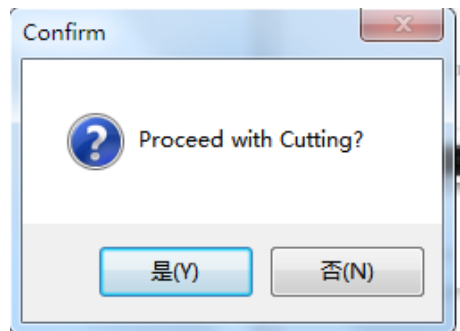

(pic 5-10)

The output is completed, the cutting plotter is cutting

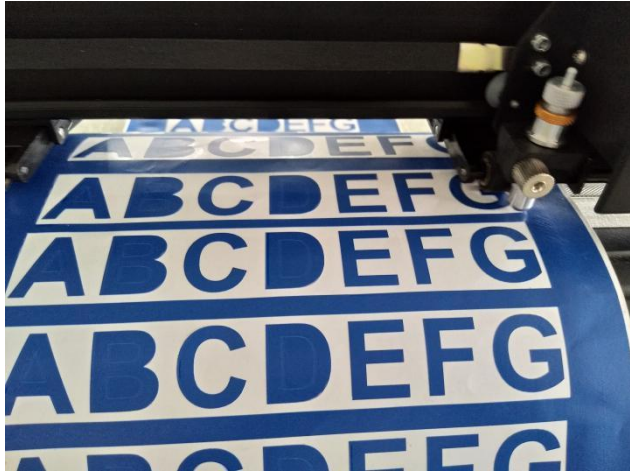

(pic 5-11)

Note: Please refer to the USB flash drive for specific operation, including the following videos

1. Ordinary cutting video
2. Automatic contour video
3. Automatic deviation correction video
4. Software installation video