

VEVOR[®]

TOUGH TOOLS, HALF PRICE

Technical Support and E-Warranty Certificate www.vevor.com/support

DOG GROOMING TUB

MODEL: K1E01025/K1E01026

We continue to be committed to provide you tools with competitive price.

"Save Half", "Half Price" or any other similar expressions used by us only represents an estimate of savings you might benefit from buying certain tools with us compared to the major top brands and does not necessarily mean to cover all categories of tools offered by us. You are kindly reminded to verify carefully when you are placing an order with us if you are actually saving half in comparison with the top major brands.

VEVOR®

TOUGH TOOLS, HALF PRICE

DOG GROOMING TUB

MODEL: K1E01025/K1E01026

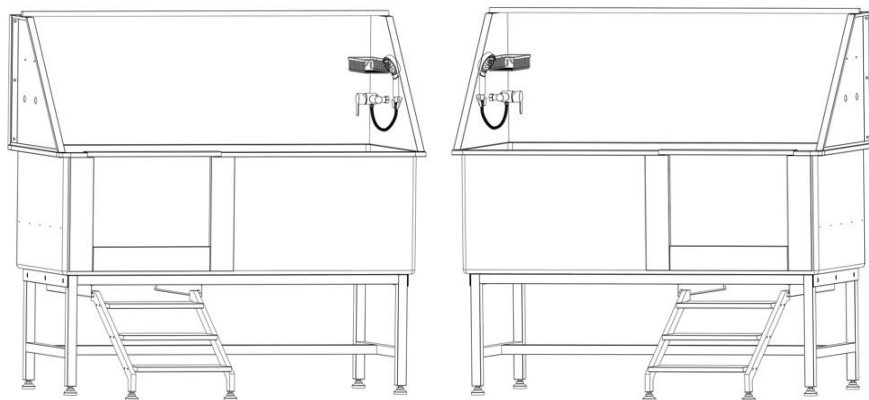

NEED HELP? CONTACT US!

Have product questions? Need technical support? Please feel free to contact us:

Technical Support and E-Warranty Certificate
www.vevor.com/support

This is the original instruction, please read all manual instructions carefully before operating. VEVOR reserves a clear interpretation of our user manual. The appearance of the product shall be subject to the product you received. Please forgive us that we won't inform you again if there are any technology or software updates on our product.

IMPORTANT SAFEGUARDS



WARNING: Read and understand this entire manual before operating or servicing this product. Failure to follow these warnings and instructions can cause personal injury or damage to valuable property.

- Avoid children using grooming tub. And this product is not a toy. Do not allow children to play.
- Keep away from sharp points, blades and other items.
- Assembly precautions
 1. Assemble only according to these instructions. Improper assembly can create hazards.
 2. Wear ANSI-approved safety goggles and heavy-duty work gloves during assembly.
 3. Keep assembly area clean and well-lit.
 4. Keep bystanders out of the area during assembly.
 5. Do not assemble when tired or when under the influence of alcohol, drugs or medication.
 6. Product capabilities apply to properly and completely assembled product only.
 7. For additional information regarding the parts listed in the following pages, please refer to the Assembly Diagram of this manual. Unwrap and separate all parts in a clean work area. Please keep small spare parts out of children's reach.

SAVE THESE INSTRUCTIONS

PREPARATIONS BEFORE INSTALLATION

1. Recommended Tools:

Phillips screwdriver, M4 wrench, Spirit level,

2. Necessary safety equipment:











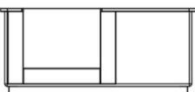

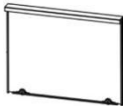
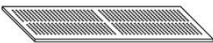
Gloves, goggles.

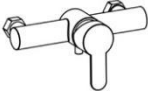



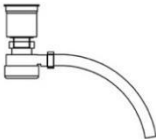











Caution: Before installing the product, wear gloves and goggles to avoid possible physical damage during installation.

INSTRUCTIONS

Thank you very much for choosing this pet bathtub. Please read all the instructions before using it. The information will help you achieve the best possible results.

Parts List:

			
A*2	B*1	C*1	D*1
Bottom bracket	Tub	Right side panel	Left side panel
			
E*1	F*1	G*1	H*1
Door	Water filter plate	Back panel	Faucet switch
			
J*1	K*1	L*1	M*2 (600mm)
Storage basket	Shower head	Shower hose	Inlet pipe
			

N*1	P*4 (M4*15mm)	Q*4 (M4)	R*2
Strainer	Screw	Hex flange nut	Nut
			
S*1	T*1	U*6	V*2
Shower bracket	Comb	Adjustable foot	Sling
			
W*2	Y*20 (M6*15mm)	Z*12 (M6*35mm)	AA*1
Play ball	Screw	Screw	Gloves
			
AB*1		AC*2	AD*2
Crossbar		Washer	Nut
			
AE*1	AF*1	AG*1	AH*3
Sealing tape	Handle	Wrench	Stair board
			
AJ*2			
Ladder rod			

Installation steps

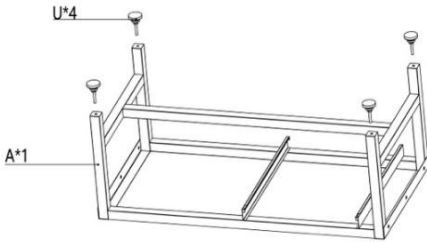

① Install the adjustable feet(U) to the H rack(A).

Caution:Ensure that the depth of adjustable feet is not less than 12mm, and try to make the four adjustable feet screw in the same depth. Please tighten the spare nut during the installation, and adjust it later.

Left Door Bracket

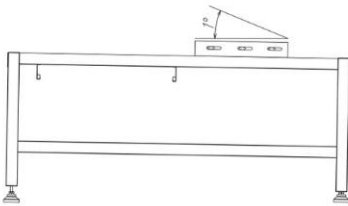

Right Door Bracket

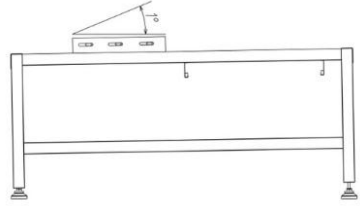

② Flip the bottom bracket, adjust the height of the feet to make sure the height of water outlet side is 1-2 degrees lower than the other side (use a spirit level to show)

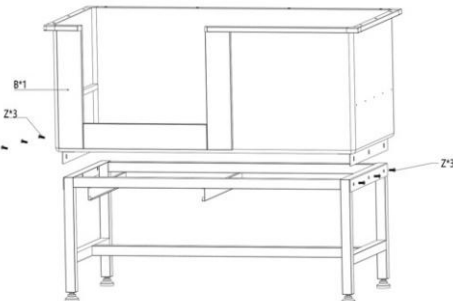

③ Use screw(Z) to fix the bottom bracket and tub(B)

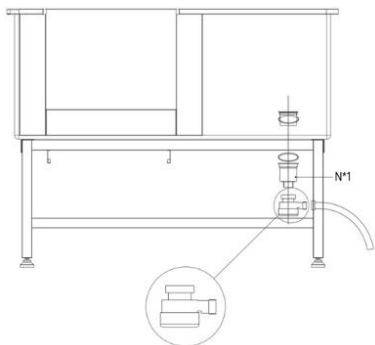

④ Install the strainer(N),Ensure that the sealing ring is free of dislocation and wrinkles.
Caution:When installing, please pay attention to whether the sealing ring is placed correctly,avoid water leakage due to incorrect seal installation.

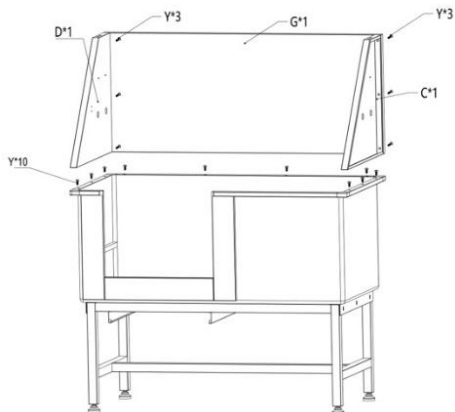

⑤ Use screw(Y) to fix the left and right side board(D&C), then use screw(Y) to fix the back panel(G), last to use screw(Y) to fix side board(D&C) and back board(G)

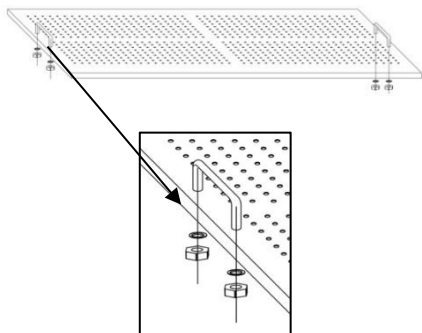

⑥ Install the handle(AF) to the water filter plate(F)

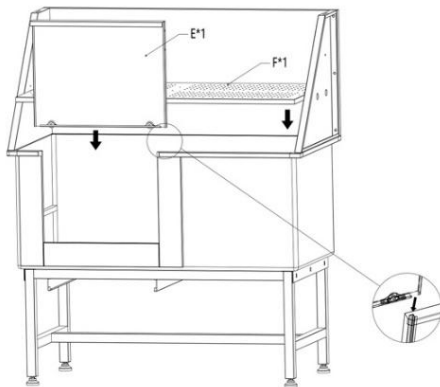

⑦ Install door(E) and put the water filter plate to the tub(B)

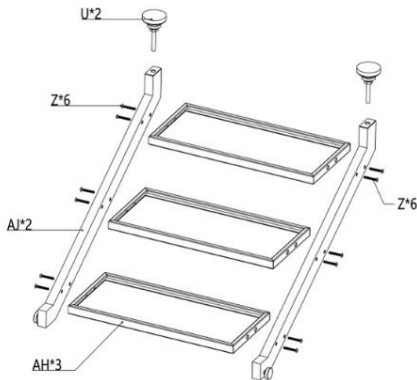

⑧ Use screw(Z) to fix the stair board(AH) and ladder rod(AJ), then install the adjustable feet(U) on the bottom of the ladder rod(AH).
Caution: Ensure that the depth of adjustable feet is not less than 12mm, and try to make the two adjustable feet screw in the same depth. and tighten the spare nut during the installation.

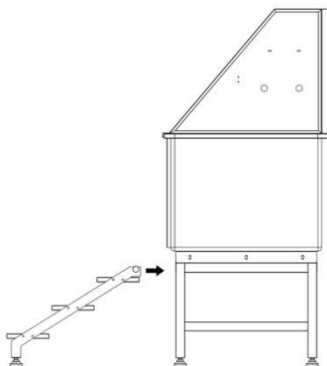

⑨ Install the stairs into the chassis rails

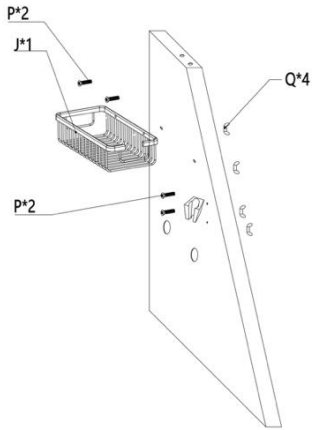

⑩ Use screw(P) and hex flange nut(Q) to install the storage basket(J) and shower bracket(S) to the right side panel(C)

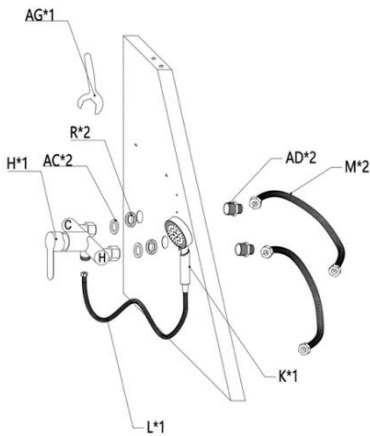

⑪ Install hot and cold shower switch and water inlet.
Caution: Before you do this, make sure that your water source is on the left or right side of the bathtub, and select the direction of installation of the tap switch.

Step1: Pass straight all-copper connector(AD) through side panel (1/2 “ end facing outside), screw nut R2 into the other end of the connector and use wrench(AG) screw down.

Step2: Align the faucet switch (H) with the connector (AD), then tighten the two nuts on the switch (H), and note that the sealing ring inside the nut is intact.

Step3: Connect the hose (M) at the water inlet end and the shower hose (L) at the faucet outlet. Also, when tightening the nut, pay attention to whether the sealing ring inside the nut is intact.

Step4: The other end of the hose (M) is connected to the water source, pay attention to the hot and cold water mark on the faucet switch (H), “H” represents hot water, and connect the hose on this side to the hot water source, while the other side is connected to the cold, also pay attention to whether the seal ring inside the hose end nut is intact.

Caution:The inlet hose is only 600mm long, if you want to lengthen it, please purchase it separately (Caliber:20mm)

Caution:Optional use of sealing tape(AE) when installing the nut(AD).It can make the installation more sealed and help prevent water leakage at the joint.

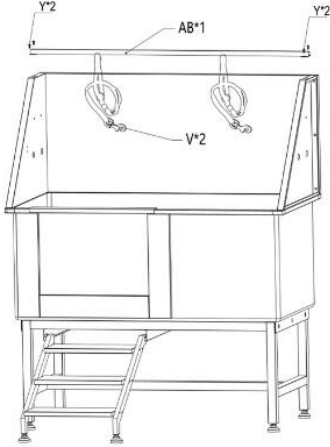

⑬ Use screw(Y) to fix the crossbar (AB) to the left and right-side panel, then install the sling(V)

SAVE THIS MANUAL

Left Door

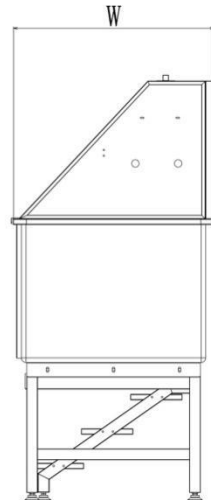
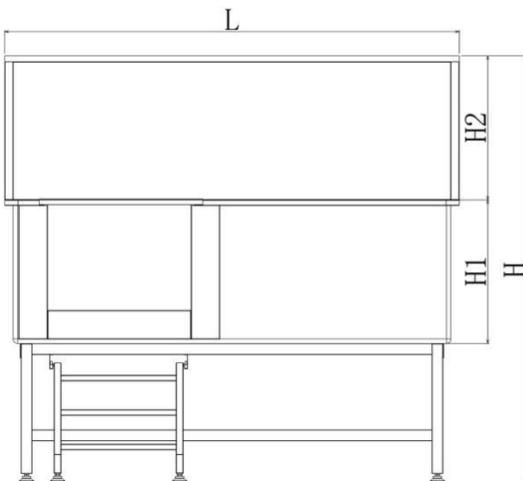

Right Door

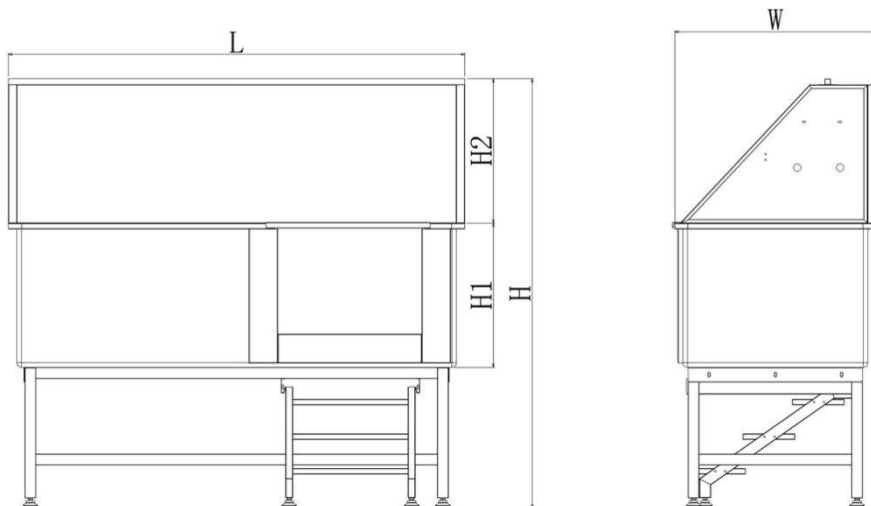

Model#	L(mm)	H(mm)	H1(mm)	H2(mm)	W(mm)	N.W. (kg)
K1E01025	1500	1491	500	480	700	59.7
K1E01026	1500	1491	500	480	700	59.7

Model#	Volume (CBM)	Loading Capacity (lbs)	Recommended pet (in)
K1E01021	0.88	330	L×W×H:59×27×45
K1E01022	0.88	330	L×W×H:59×27×45

OPERATION

1. Make sure the water pipe connection is complete and the water is flowing normally. (Connect the hot and cold water pipes according to the hot and cold water signs of the faucet switch).

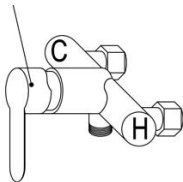

"C": Cold water; "H": Hot water

2. Pull out the stairs and open the door, let the pet walk into the bathtub by itself or hold the pet inside the tub by yourself, then close the door.
3. Start to bath.
4. After the bath, let the water out of the tub and take the animal out.
5. Clean the tub with a cloth.

MAINTENANCE

1. In between use, the tub should be cleaned with a soft cloth or sponge using a mild cleaning agent.

2. Pay attention to regularly clean the hair of the drain to avoid clogging.

3. Please clean the transparent cover of the drain regularly. After disassembly like a nut, it can be easily cleaned, and be careful not to leave the seal ring when installing it back.

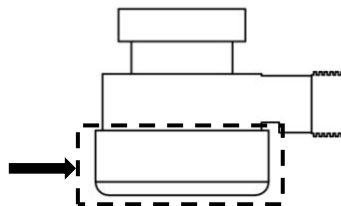

CARE INSTRUCTIONS

Don't put the bathtub on an uneven surface.

Don't drop or mistreat the bathtub.

Don't overload the scale. This will permanently damage it!

COMMON MALFUNCTIONS

If the faucet leaks, please check whether the waterproof rubber plug is installed. If it is damaged, it needs to be replaced in time.

Manufacturer: Shanghaimuxinmuyeyouxiangongsi

Address: Shuangchenglu 803nong11hao1602A-1609shi, baoshanqu, shanghai 200000 CN.

Imported to AUS: SIHAO PTY LTD. 1 ROKEVA STREETEASTWOOD NSW 2122 Australia

Imported to USA: Sanven Technology Ltd. Suite 250, 9166 Anaheim Place, Rancho Cucamonga, CA 91730

UK	REP
-----------	------------

YH CONSULTING LIMITED. C/O YH Consulting Limited Office 147, Centurion House, London Road, Staines-upon-Thames, Surrey, TW18 4AX

EC	REP
-----------	------------

E-CrossStu GmbH
Mainzer Landstr.69,
60329 Frankfurt am Main.

VEVOR[®]

TOUGH TOOLS, HALF PRICE

Technical Support and E-Warranty Certificate

www.vevor.com/support