

VEVOR[®]

TOUGH TOOLS, HALF PRICE

Technical Support and E-Warranty Certificate www.vevor.com/support

GRIDWALLS USER MANUAL

MODEL:YD0024

We continue to be committed to provide you tools with competitive price.

"Save Half", "Half Price" or any other similar expressions used by us only represents an estimate of savings you might benefit from buying certain tools with us compared to the major top brands and does not necessarily mean to cover all categories of tools offered by us. You are kindly reminded to verify carefully when you are placing an order with us if you are actually saving half in comparison with the top major brands.

VEVOR®

TOUGH TOOLS, HALF PRICE

GRIDWALLS

MODEL:YD0024

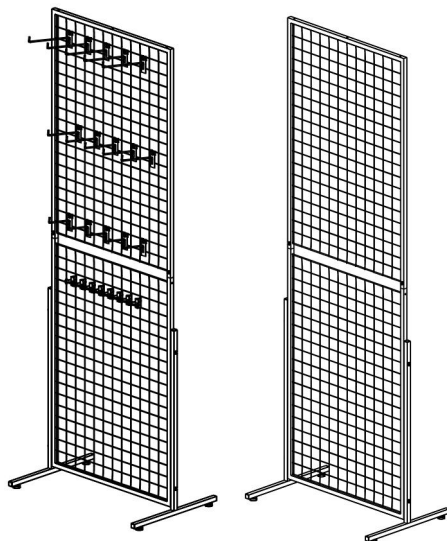

NEED HELP? CONTACT US!

Have product questions? Need technical support? Please feel free to contact us:

 CustomerService@vevor.com

This is the original instruction, please read all manual instructions carefully before operating. VEVOR reserves a clear interpretation of our user manual. The appearance of the product shall be subject to the product you received. Please forgive us that we won't inform you again if there are any technology or software updates on our product.

SAFETY INSTRUCTIONS

WARNING:

Read this material before using this product. Failure to do so can result in serious injury.

Assembly precautions

1. Assemble only according to these instructions. Improper assembly can create hazards.
2. Wear ANSI-approved safety goggles and heavy-duty work gloves during assembly.
3. Keep the assembly area clean and well-lit.
4. Keep bystanders out of the area during assembly.
5. Do not assemble when tired or when under the influence of alcohol, drugs or medication.
6. The product capabilities apply to properly and completely assembled products only.
7. Assemble on a flat, level, hard and smooth surface capable of safely supporting the Gridwalls.
8. For additional information regarding the parts listed in the following pages, please refer to the Assembly Diagram of this manual. Unwrap and separate all parts in a clean work area.

Use precautions

1. DO NOT SIT OR STAND ON THIS ITEM.
2. This product is not a toy. Do not allow children to play with or near this item.
3. Do not exceed weight capacities.
4. Use only on a flat, level, hard and smooth surface capable of safely supporting a fully loaded Gridwalls.
5. Use as intended only.
6. Inspect before every use; do not use if parts are loose or damaged.

SAVE THIS MANUAL

PARTS LIST

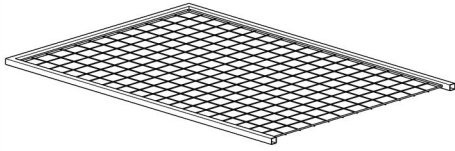

1.Top Mesh x2

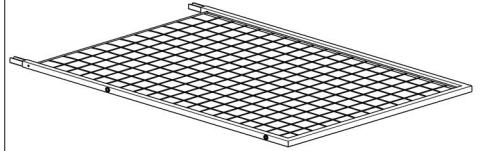

2.Bottom Mesh x2

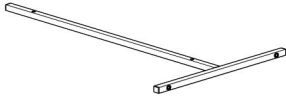

3.Foot Frame x4

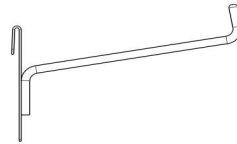

4.Pot Hook_Small x5

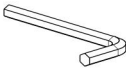

5.Spanner x1

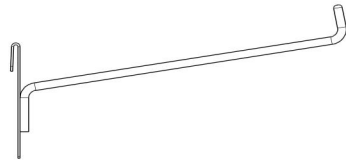

6.Pot Hook_Middle x5

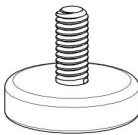

7.LevelingFoot x8

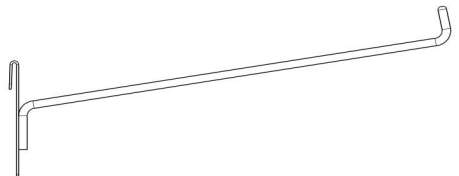

8.Pot Hook_Large x5



9.Screw_A x4

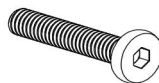

10.Screw_B x8



11.Clip x8

ASSEMBLY STEP

step 1

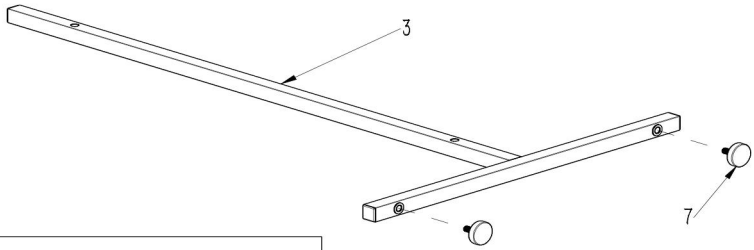

Component 1

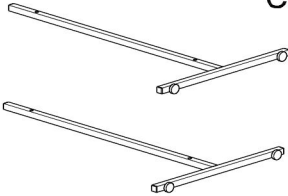

7



X4

step 2

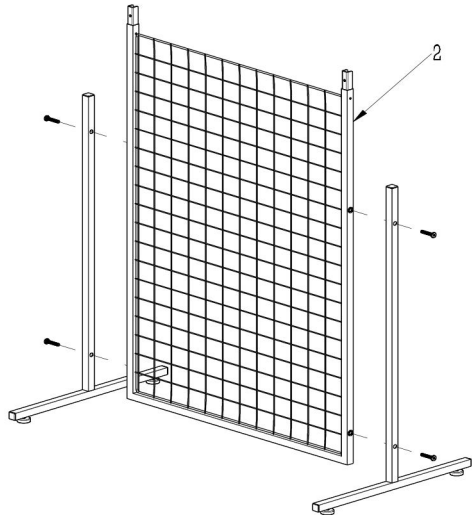

Component 2

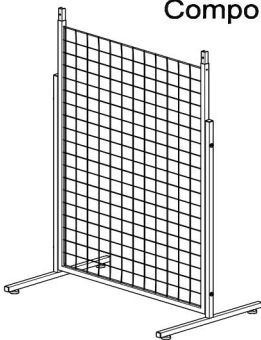

10



X4

step 3

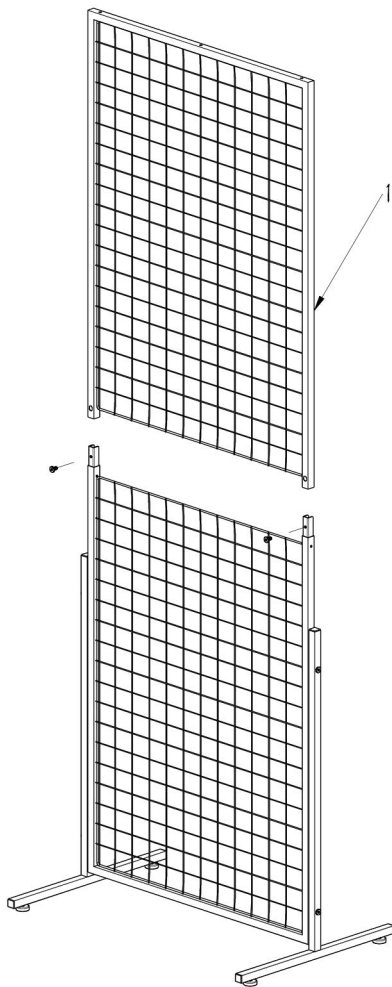

Component 3

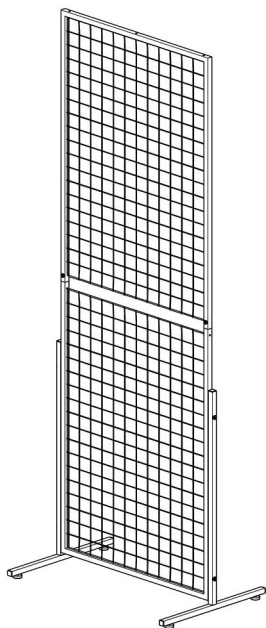

9



X2

step 4

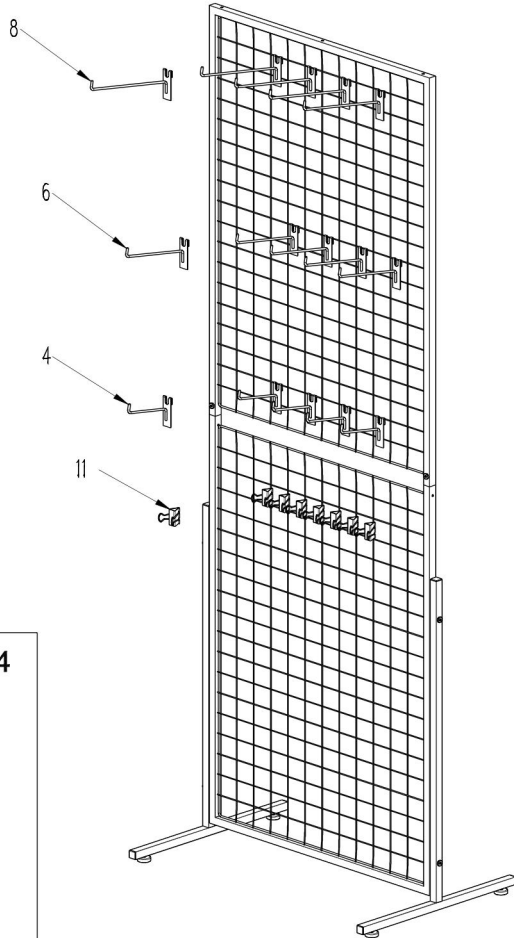

Component 4

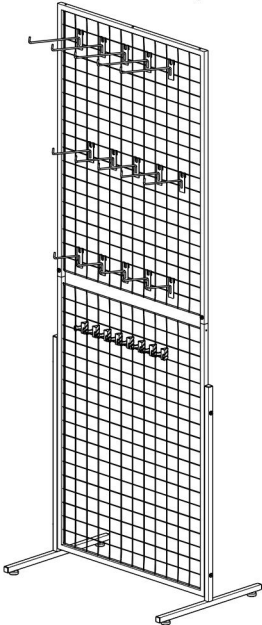

COMPLETION

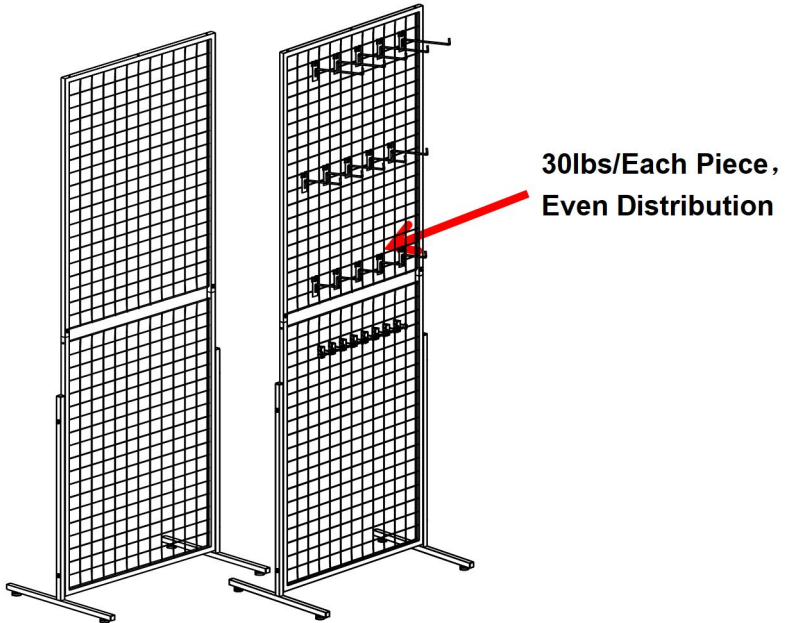

PRODUCT PARAMETER

Model	YD0024
Loading Weight	30 lbs per piece
Product Size	1716*617*404 mm /piece
Net Weight	6.35 kg

Address: Baoshanqu Shuangchenglu 803long 11hao 1602A-1609shi Shanghai

Imported to AUS: SIHAO PTY LTD, 1 ROKEVA STREETEASTWOOD NSW 2122 Australia

Imported to USA: Sanven Technology Ltd.Suite 250, 9166 Anaheim Place, Rancho Cucamonga, CA 91730



SHUNSHUN GmbH
Römeräcker 9 Z2021,76351
Linkenheim-Hochstetten,Germany



Pooledas Group Ltd
Unit 5 Albert Edward House, The Pavilions
Preston, United Kingdom

Made In China

VEVOR[®]

TOUGH TOOLS, HALF PRICE

Technical Support and E-Warranty Certificate

www.vevor.com/support