

VEVOR[®]

TOUGH TOOLS, HALF PRICE

Technical Support and E-Warranty Certificate www.vevor.com/support

CAR SIDE AWNING USER MANUAL

We continue to be committed to provide you tools with competitive price.

"Save Half", "Half Price" or any other similar expressions used by us only represents an estimate of savings you might benefit from buying certain tools with us compared to the major top brands and does not necessarily mean to cover all categories of tools offered by us. You are kindly reminded to verify carefully when you are placing an order with us if you are actually saving half in comparison with the top major brands.

VEVOR[®]

TOUGH TOOLS, HALF PRICE

CAR SIDE AWNING

Model: ATSA1420, ATSA2025

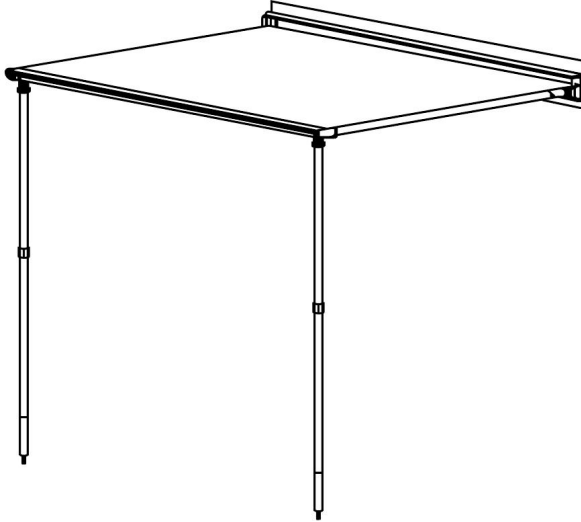

NEED HELP? CONTACT US!

Have product questions? Need technical support? Please feel free to contact us:

Technical Support and E-Warranty Certificate
www.vevor.com/support

This is the original instruction, please read all manual instructions carefully before operating. VEVOR reserves a clear interpretation of our user manual. The appearance of the product shall be subject to the product you received. Please forgive us that we won't inform you again if there are any technology or software updates on our product.

SPECIFICATIONS

Model	ATSA1420
Product Size	4.6×6.6ft
Color	Biege

Model	ATSA2025
Product Size	6.6×8.2ft
Color	Biege

COMPONENTS

SN	FITTING LIST-SPECIFICATIONS	PICTURE
1	Manual x1	
2	Stainless Steel Ground Peg x2	
3	Black Powdercoated Steel L - Bracket x2	
4	Black Powdercoated Steel Backing Plate x2	
5	2.7m Rope with Plastic Fixed unit x2	
6	SS304 M8X20mm bolt x4	
7	SS304 M8X55mm bolt x4	
8	SS304 M8 Nylock nut X8	
9	Carry Bag x1	

Simply follow the easy assembly instructions in this manual, and follow the setup and safety guidelines closely.

Inspections: during trips regularly check that all nuts and bolts attaching your awning to your vehicle are tight and in good repair.

IMPORTANT SAFETY WARNING

- Do not attempt to set up the awning in windy conditions.
- All guy ropes must be properly attached to the awning and pegged to the ground at all times.
- Guy ropes are trip hazards in the day and night.
- Keep all flame and heat sources away from the awning materials. Under no circumstance should any naked flame sources, fuel burning devices or heating devices be used under or near the awning.
- Keep campfires well away from awning.
- Keep a look out for any airborne burning embers that may come into contact with the awning.
- Keep a fire extinguisher or water bucket nearby.
- Do not smoke within the awning. Keep exit clear.

FITTING GUIDE

Options for mounting your awning are outlined below.

It is important when mounting the awning to ensure it is positioned to allow sufficient clearance for the vehicle doors to open.

■ INSTALLATION

● FOR ROOFTOP RACK

NOTE: You can choose option A or option B to install according to your requirement.

OPTION A

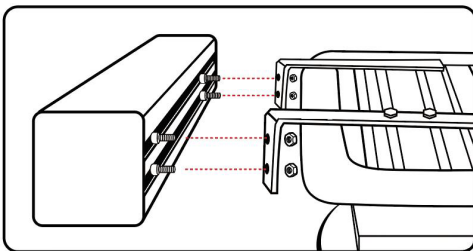

OPTION B

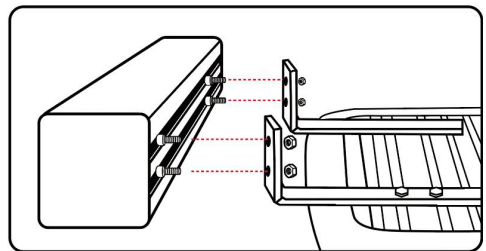

●FOR ROOFTOP BASKET

NOTE: You can choose option A or option B to install according to your requirement.

OPTION A

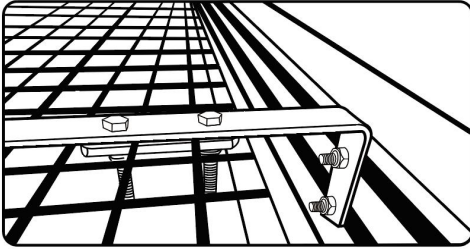

OPTION B

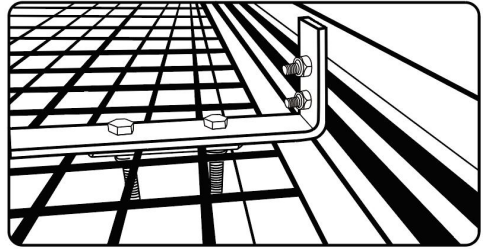

●FOR CROSS BAR (DRILLING MIGHT BE NEEDED)

NOTE: If there are no holes in the cross bar, it is necessary to drill the holes before installing the bracket.

STEP 1: Cross bar drilling

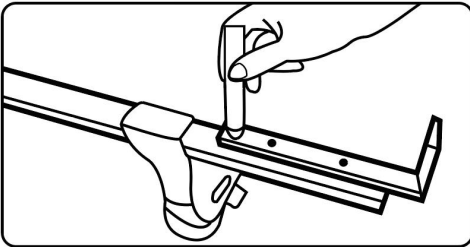

STEP 2: Bracket installing

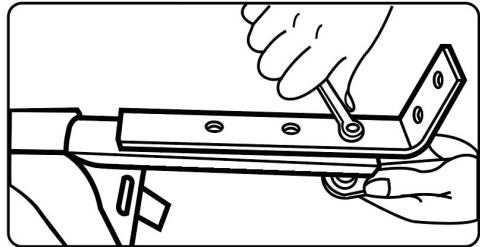

Note: Partial DIY might needed due to different fittings of rooftop rack models. Not all provided parts are necessary to be used for installation, some of them are backups for different models.

■ **SETUP**

STEP1

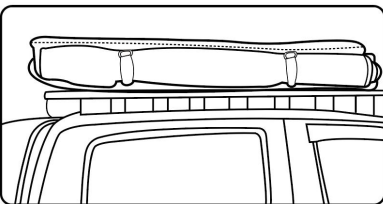

Unzip the PVC Protective Bag

STEP2

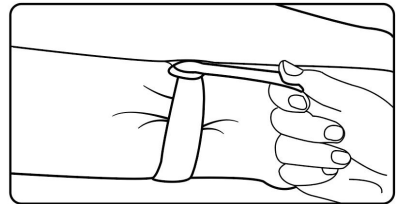

Unhook the straps

STEP3

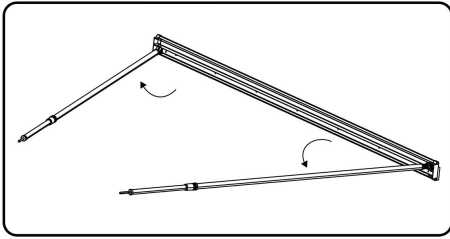

Open the lateral support poles.

STEP4

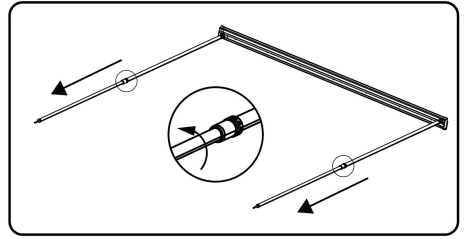

Rotate the lower part of the poles to adjust the length of the pole.

STEP5

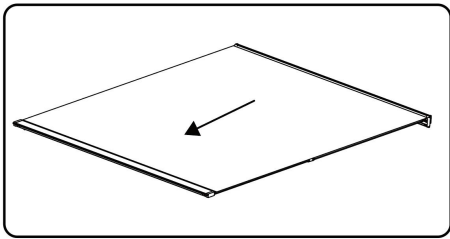

Unfold the awning.

STEP6

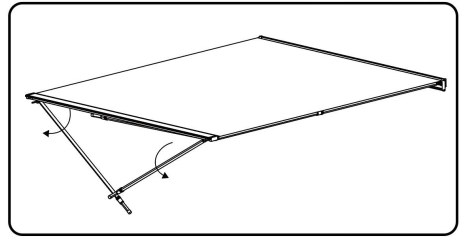

Open the vertical support poles.

STEP7

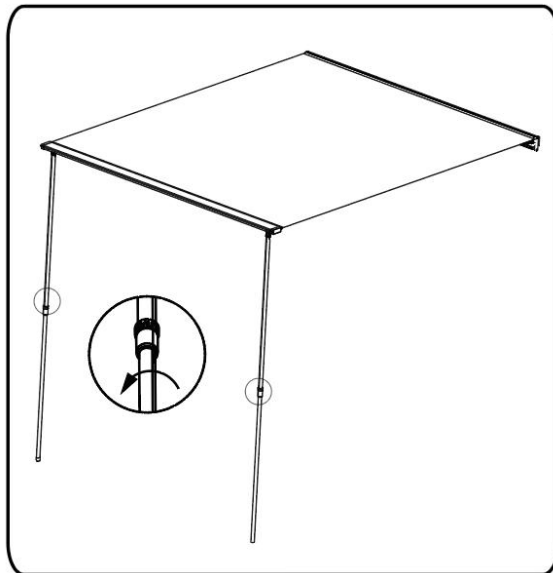

Rotate the lower part of the poles to adjust standing height.

STEP8

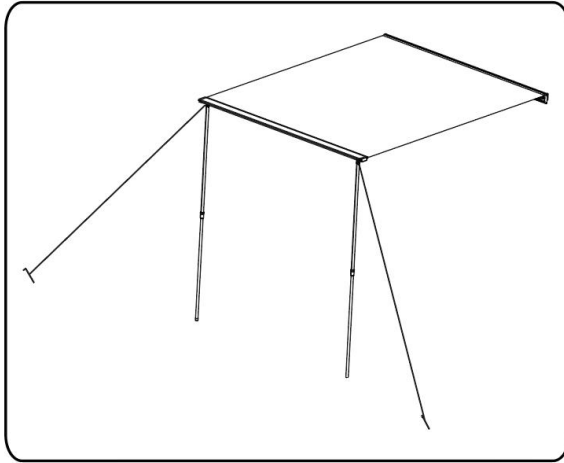

Tie camping ropes through joint holes, set ground pegs and tension all ropes.

SETUP PROCEDURE

1. Clean only with cold water and a soft brush-do not use soap or detergent.
2. Do not expose to petrol, oil or solvents
3. Avoid creases and seams when rolling up the awning.

Manufacturer: Shanghaimuxinmuyeyouxiangongsi

Address: Shuangchenglu 803nong11hao1602A-1609shi, baoshanqu, shanghai 200000 CN.

Imported to AUS: SIHAO PTY LTD. 1 ROKEVA STREETEASTWOOD NSW 2122 Australia

Imported to USA: Sanven Technology Ltd. Suite 250, 9166 Anaheim Place, Rancho Cucamonga, CA 91730



E-CrossStu GmbH
Mainzer Landstr.69, 60329 Frankfurt am Main.



YH CONSULTING LIMITED.
C/O YH Consulting Limited Office 147, Centurion House,
London Road, Staines-upon-Thames, Surrey, TW18 4AX

VEVOR[®]

TOUGH TOOLS, HALF PRICE

Technical Support and E-Warranty Certificate

www.vevor.com/support