

# **VEVOR<sup>®</sup>**

## **TOUGH TOOLS, HALF PRICE**

Technical Support and E-Warranty Certificate [www.vevor.com/support](http://www.vevor.com/support)

### **POOL FENCE USER MANUAL**

We continue to be committed to provide you tools with competitive price.

"Save Half", "Half Price" or any other similar expressions used by us only represents an estimate of savings you might benefit from buying certain tools with us compared to the major top brands and does not necessarily mean to cover all categories of tools offered by us. You are kindly reminded to verify carefully when you are placing an order with us if you are actually saving half in comparison with the top major brands.

# VEVOR<sup>®</sup>

TOUGH TOOLS, HALF PRICE

## POOL FENCE

Model: NLSSHL412, NLSSHL448, NLSSHL472, NLSSHL496,  
NLSSHL4108

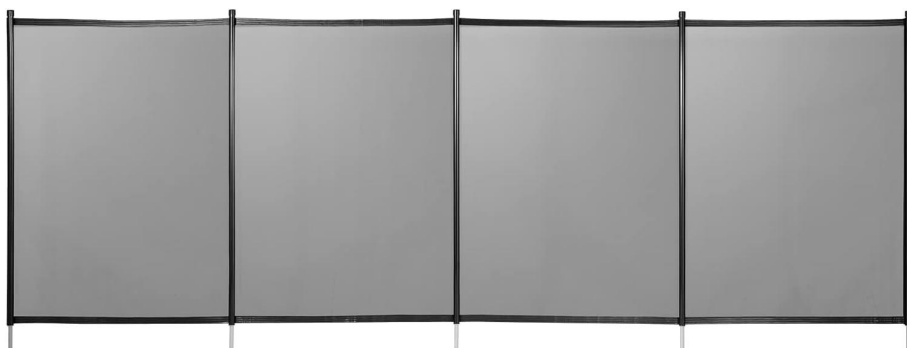

### NEED HELP? CONTACT US!

Have product questions? Need technical support? Please feel free to contact us:

**Technical Support and E-Warranty Certificate**  
[www.vevor.com/support](http://www.vevor.com/support)

This is the original instruction, please read all manual instructions carefully before operating. VEVOR reserves a clear interpretation of our user manual. The appearance of the product shall be subject to the product you received. Please forgive us that we won't inform you again if there are any technology or software updates on our product.

**THIS SAFETY FENCE IS INTENDED TO LIMIT THE ACCESS OF THE POOL TO CHILDREN UNDER FIVE YEARS. THIS FENCE IS INTENDED FOR INDIVIDUAL USE ONLY.**

**Important recommendations**

Before starting, it is important to know which rules must be followed when installing the barrier.

- The barrier must isolate the pool and all its points of access completely.
- All sides of the pool must be protected, whether with the barrier itself or a fixed element such as a wall, a panel or any other type of fence, as long as this element complies with the NF P 90 -306 standard (particularly with the part stating that said element must never have a clearance height inferior to 1.10 m).
- In the case that the barrier must be connected to another element, make sure that it is firm enough to provide a stable point of attachment.
- Do not install the barrier on an unstable surface such as grass, sand.**WARNING:** it is imperative to maintain a corridor of at least 1.10m between the barrier and any fixed or movable point of attachment (on each side of the barrier).
- We recommend installing the barrier at a minimum distance of 2' above water level. In private pools for individual use, we recommend installing the barrier not too far from the pool itself so that its efficiency is not reduced.
- However, when calculating the distance between the pool and the barrier, take into consideration the minimum distance required for carrying out maintenance tasks such as vacuuming. Do not leave a small distance which could impair maintenance tasks.
- Before installing this product, please read and follow all the warnings and instructions that accompany this product. Failure to comply with the safety warnings and instructions could cause injuries, death or material damages.
- Please keep this instruction manual for future consultation.
- We reserve to change all of part of the articles or contents of this document, without prior notice.

# SPECIFICATIONS

Model	NLSSHL412
Product Size	4*12ft
Color	Black





Model	NLSSHL448
Product Size	4*48ft
Color	Black

Model	NLSSHL472
Product Size	4*72ft
Color	Black

Model	NLSSHL496
Product Size	4*96ft
Color	Black

Model	NLSSHL4108
Product Size	4*108ft
Color	Black

## PARTS LIST

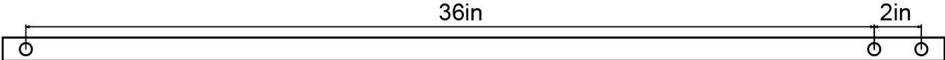
 <p>Pool fence</p> <p>x1</p>	 <p>Peg</p>  <p>Peg cover</p> <p>NLSSHL412 x5            NLSSHL448 x17            NLSSHL472 x25            NLSSHL496 x33            NLSSHL4108x37</p>	 <p>Hook (Installed on the fence)</p> <p>x1</p>
 <p>36in</p> <p>2in</p> <p>Template for hole placement x1</p>		

## Required tools

1. Rotary Hammer Drill	8. Scissors
2. Concrete drill bit $\varnothing 16$ and $\varnothing 10$	9. Household Stapler
3. Extension Cord	10. #2 Square Head Screw Tip
4. Tape Measure	11. Cordless Screw Gun
5. Hammer	12. 1 - Template (Incl.)
6. Marker	13. Chalk Line
7. Garden Hose	14. Spirit level

**NOTE:** This manual takes NLSSHL412 as an example for installation instructions, other models are only different in length and the installation method is the same.

## Installation

### Step 1: Layout & Mark-Out

- **Layout:** The fence should be a minimum 2' off the pool edge. See Fig. 1 & Fig 2

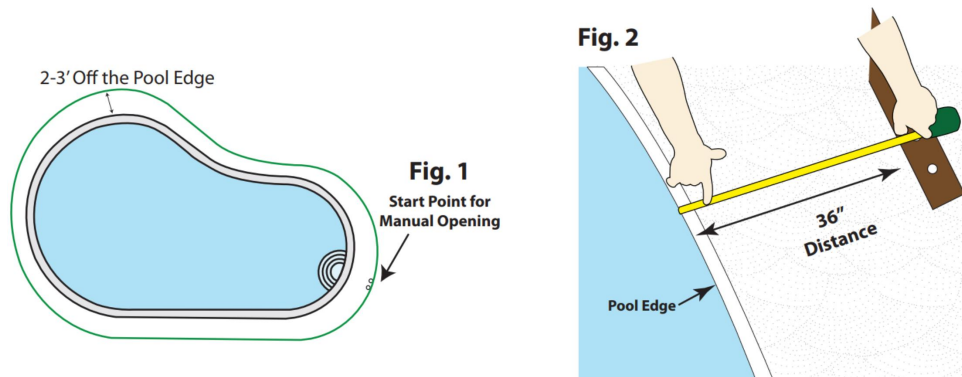

- **Start Point:** This is the manual opening to enter the pool area. See Fig. 1 Use the double hole on the section template provided and mark your first hole 1L Fig. 3. 1L is for the 1st pole of the full section going to the left side of the pool.

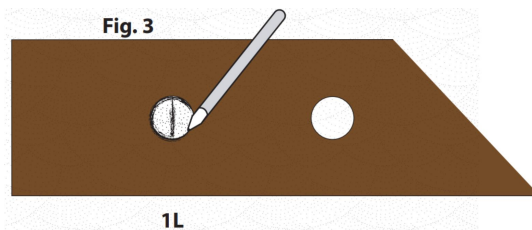

- Now, place the template over the mark 1L that you just marked and mark your next hole, 1R Fig. 4. 1R is for the 1st pole of the full section going to the right side of the pool.

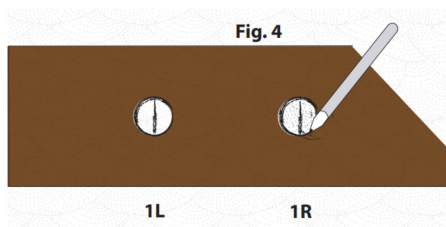

Mark-out:

- Once both holes of the start point are marked, (1L & 1R) place the template provided over 1R Fig. 5.

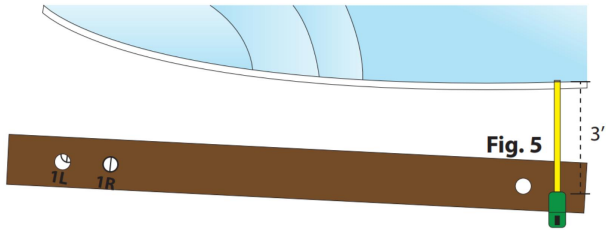

- Then place the template over 1R and mark your second hole for that section (Fig. 5a).

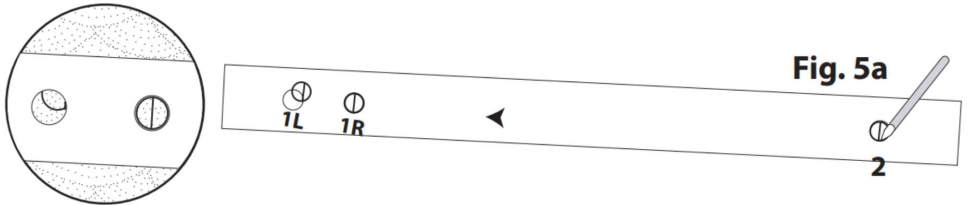

- Now repeat until the 5th pole of the section Fig. 6-7a

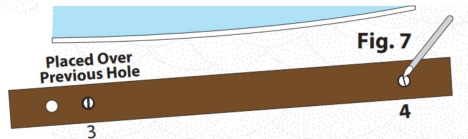
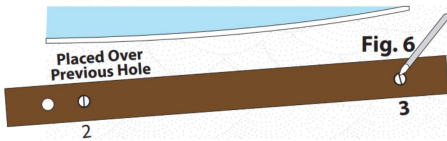

- Mark your last hole for that section, (hole 5) Fig. 7a.

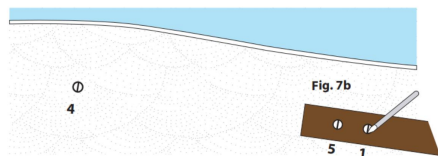
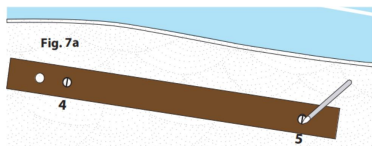

- Then use the double hole on the template and align it over the 5th hole you marked Fig. 7b and mark the first hole of the next connecting section to the right, (hole 1). Repeat these steps on both sides of the pool until you reach the section that will be the cut section.

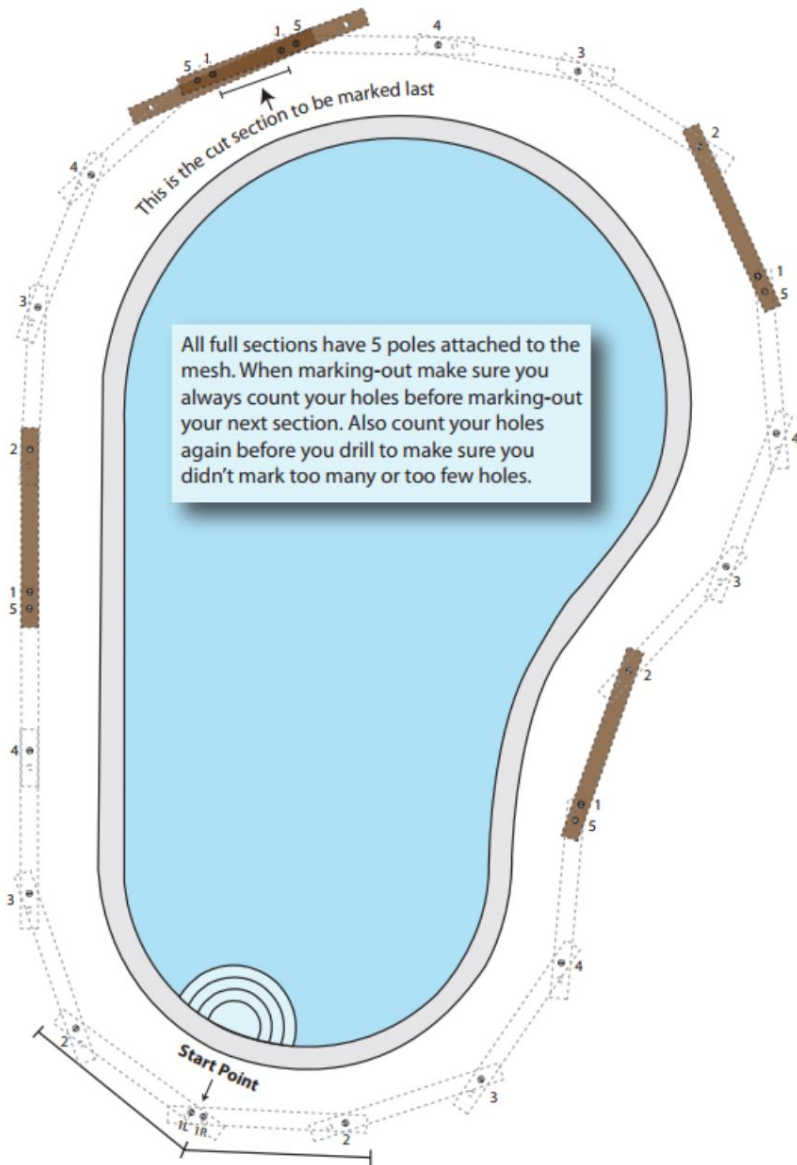

- Custom Cut: This is when the last piece is less than the 36" template. Marking your custom cut is just like marking out a full 3-foot panel only the last panel is usually shorter than 3 feet. This is the custom cut you will make later. This section is the last one marked out, usually in the back of the pool, where you will not notice it. The last piece will most likely have fewer poles in it. This example depicts a two-pole cut.



- Lay Back Holes: are needed for the manual opening and are used to place the end poles of the section into when using the pool. See Fig. 9& 10

**Fig. 9**

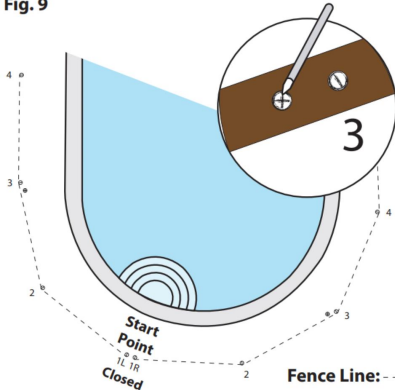

**Fig. 10**

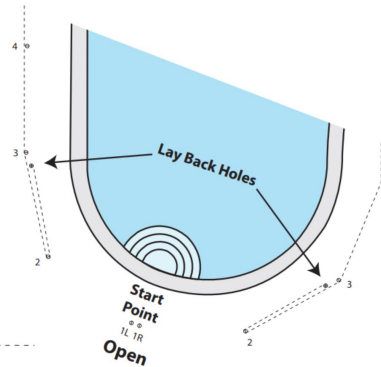

- Step 2: Understanding How to Drill
- Angle & Level Holes: Before drilling you need to survey all the holes and mark the direction in which the holes will be drilled, should it be a Light Lean Angle, Heavy Lean Angle or a Level Hole? Should the pole lean toward the pool or away from the pool or be level? See diagram below. Mark an arrow on the deck surface to avoid making a mistake. Angles are needed to ensure proper tension and aesthetics. Fig. 12 shows a Light Lean away from the pool. Fig. 13 shows a Heavy Lean toward the pool. Level holes are drilled perpendicular to the deck surface or no lean at all. See Fig. 14

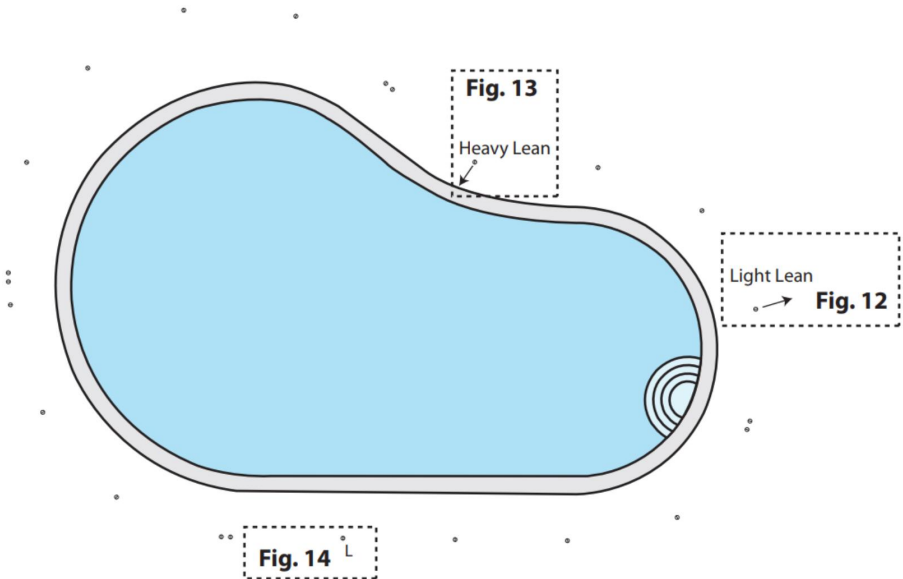

- Understand the Angle to be Drilled: See Fig. 15a-17

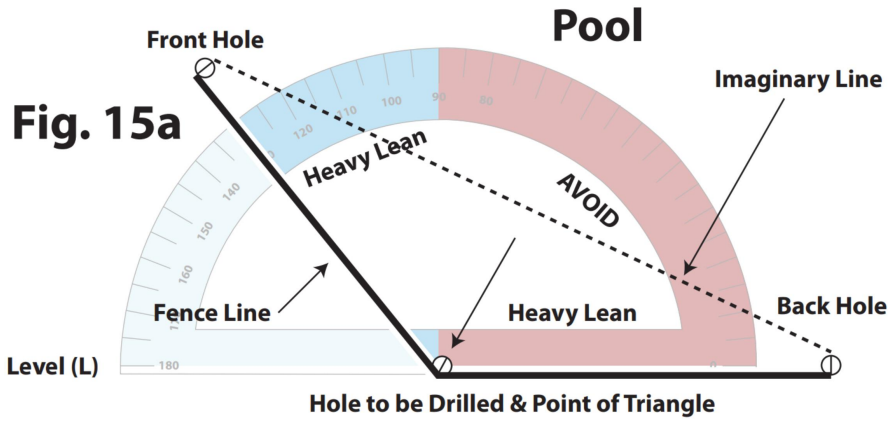

PRO NOTES: Any hole to be drilled will have a hole in front of it and one in the back of it as shown in Fig.15a. If the hole to be drilled is in the heavy lean range, it will require a Heavy Lean. If the hole to be drilled is in the light lean range, it will require a Light Lean. See Fig.15b

Imaginary Line: .....

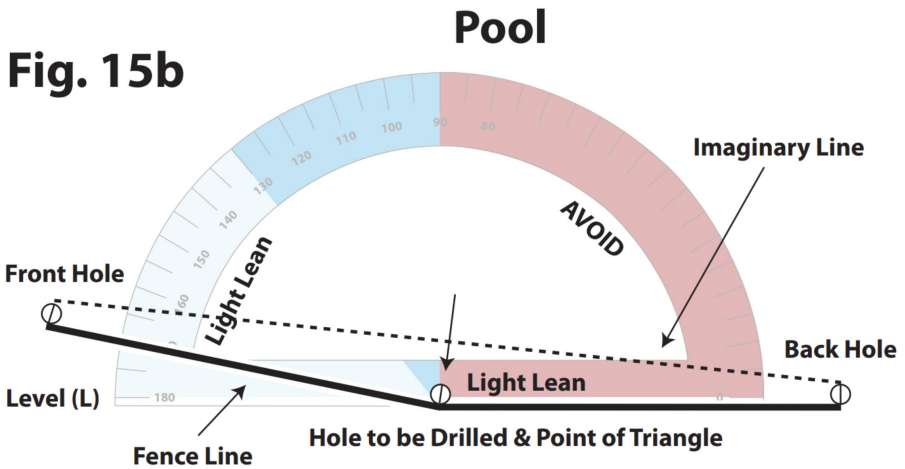

**KEY:**

LL = Light Lean

HL = Heavy Lean

L = Level

**Fig. 16**

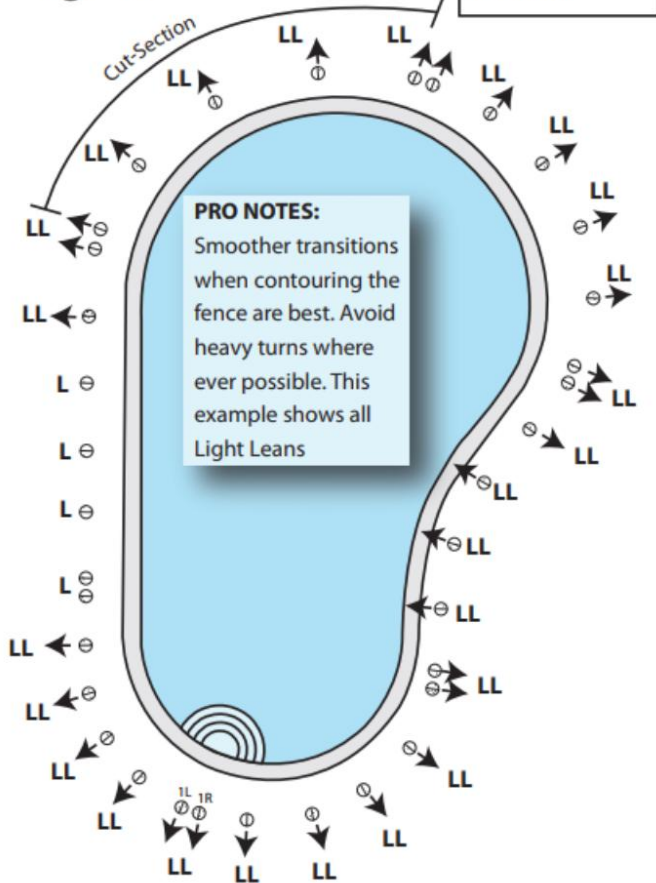

PRO NOTES: When determining the lean of a hole, simply stand over the hole you are about to drill, then look at the hole in front of you and the hole behind you. If you connected all three holes with imaginary lines it would make a triangle. The point of the triangle indicates the direction of lean. The further away from the imaginary line the more of a lean. If it doesn't make a triangle then it is level.

Imaginary Line: .....

Fence Line: \_\_\_\_\_



**Fig. 19**

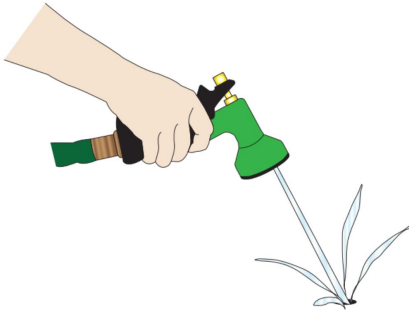

**Fig. 20**

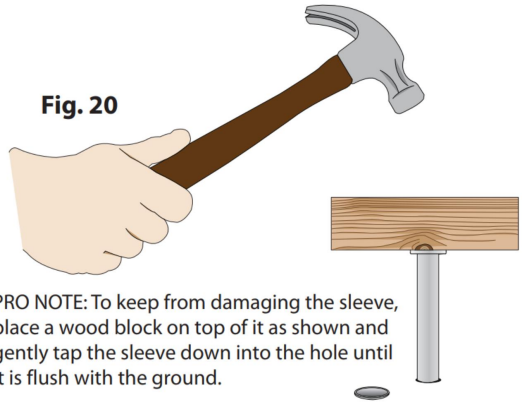

PRO NOTE: To keep from damaging the sleeve, place a wood block on top of it as shown and gently tap the sleeve down into the hole until it is flush with the ground.

- **Installing Sections:** Start at a double hole (where sections connect) and put your first pole in. You should always lean the pole you are leading with back as shown below in Fig. 20 to get it started in the hole. Then push the pole forward along the line of fence and down into the hole until the bottom of the fence is flush with the deck sleeve. Repeat this until all of your full sections are installed.

**Fig. 20**

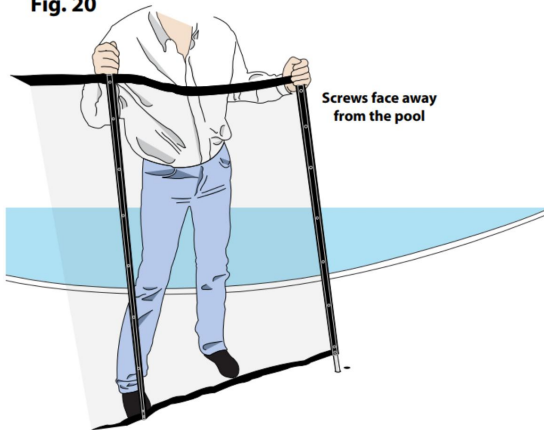

#### **Step 4: Making Your Custom Cut**

- **Measuring Your Custom Cut:** Your custom section is the one that doesn't fit. The first step is to measure your custom cut. Note whether you will be cutting from the right side or the left side of the full section. See Fig. 21 below.

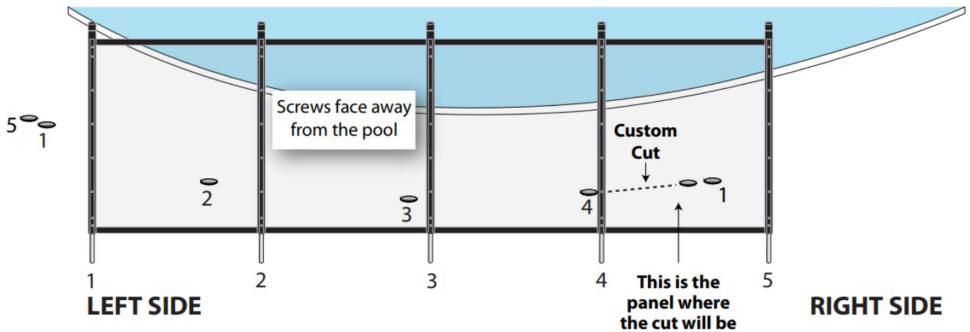
**Fig. 21**

**PRO NOTE:** When measuring for a custom cut or cutting fence you should always remember that the mold-ings face out away from the pool. When measuring your cut section, always face the pool.

**Measure the outside centerline of the odd panel. Next, count the number of poles in the odd section and double check whether it is a cut to the right or a cut to the left.**

See Fig. 22-23.

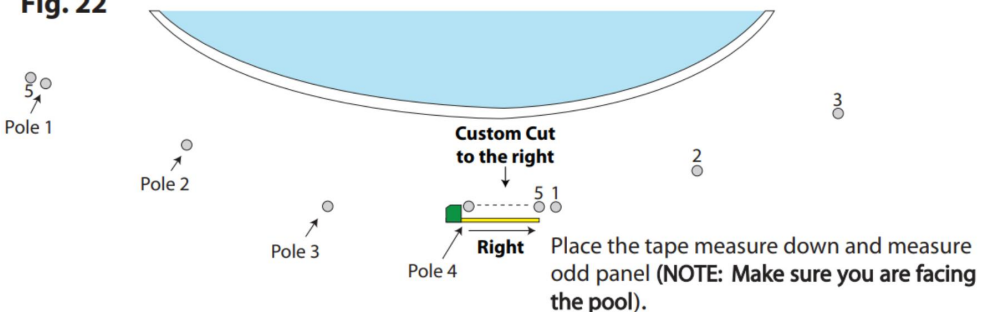
**Fig. 22****Fig. 23**

If you notice in Fig. 22 our example custom cut is a 4 pole and then a cut to the right. Let's say this cut is a 4 pole 23 1/2" to the right. When you measure make sure you are measuring between the two centerlines of either hole. Fig. 23 illustrates the scribe lines but, when you are ready to measure for your cut you will be dealing with drilled holes in the concrete and there will be no scribe lines drawn across the holes. The scribe lines in the figure are to remind you that if your cut happens to fall on a turn, you must remember that your center line turns as well.

- **Make Your Cut:** Now you have the measurement and you can make the cut. Roll out your full section (screws facing up) in front of the custom cut area and face the pool. Looking at the full section count the poles over until you reach the panel that needs to be cut. Our example cut is a 4 pole 23 1/2" to the right.

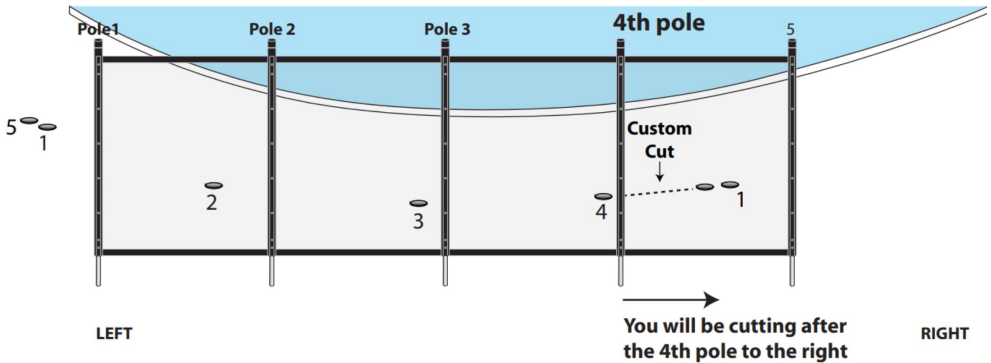

Hold your tape measure on the **OUTSIDE OF THE MOLDING** as shown in Fig. 25 and make a mark on the border at the top and bottom of the fence with a marker.

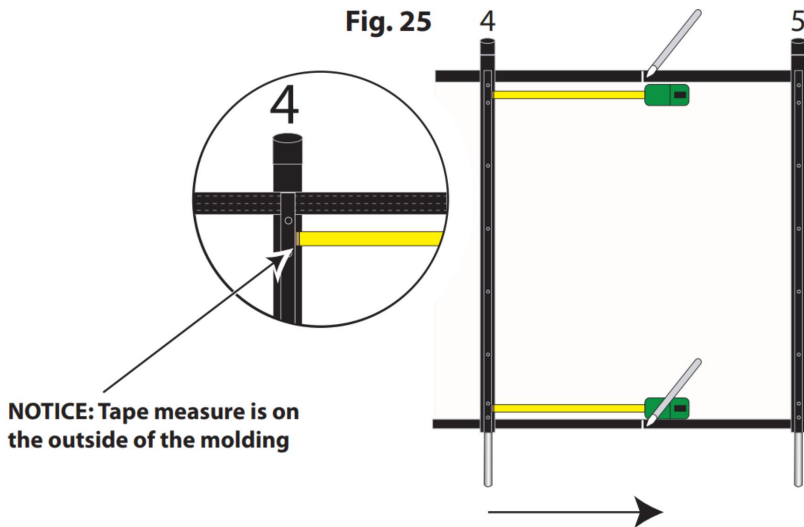

Using your scissors you can proceed to cut the mesh. Sliding your ruler up against the molding to make sure you are cutting at exactly the measurement you took. See Fig. 26 Make sure the mesh is tight and remove the extra pole from the extra piece.

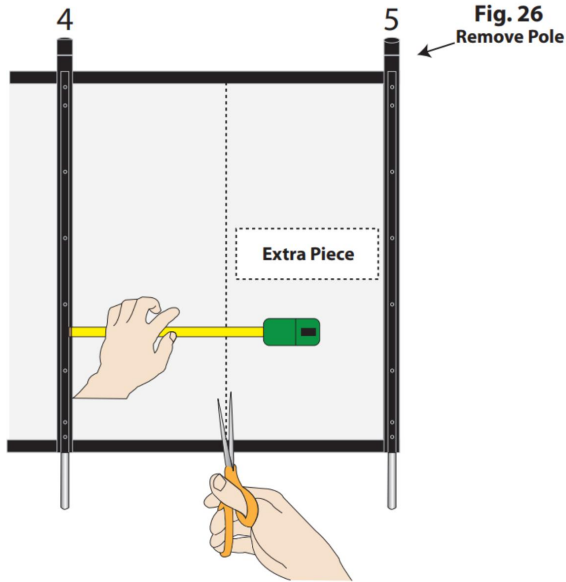

Your cut has been made and you now have to attach the border material included. Place mesh between both flaps of the border and slide the strip of border down the mesh then staple it on. Staples should be 1/4" off line of mesh in border. See Fig. 27-28. Make sure the mesh is fully inserted inside the border material included.

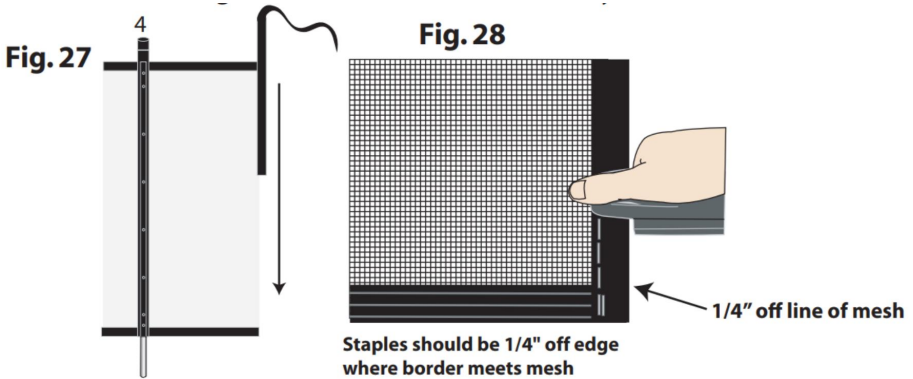

Now your border has been attached to the cut side of the mesh. Cut off excess border. Your next step is to attach the pole you removed in Fig. 26 to the cut side.



**The best way to attach your pole to the cut is as follows:**

- Lay your molding strip on top of the border you just attached. Fig. 29
- Line up molding so that it's flush with bottom & flush with line of mesh. Make sure all staples are covered by molding Fig. 29.
- Screw one screw into the molding at the top until it comes completely through the molding mesh and border.
- Then put one screw into the molding at the bottom until it comes through to the other side of the molding and mesh. Your molding should now be attached with 2 screws to the cut piece of the fence.
- Slide your pole underneath the molding & mesh, and align the screws that came through the other side to the corresponding holes of the pole. Partially back out your top screw while keeping pressure on the molding and the pole to keep it from moving. Then slowly drive the screw back down into the pole. Repeat this step for the bottom screw. See Fig. 30
- Finally place the rest of the screws into the pole and slowly screw them down. Your end pole is now attached.

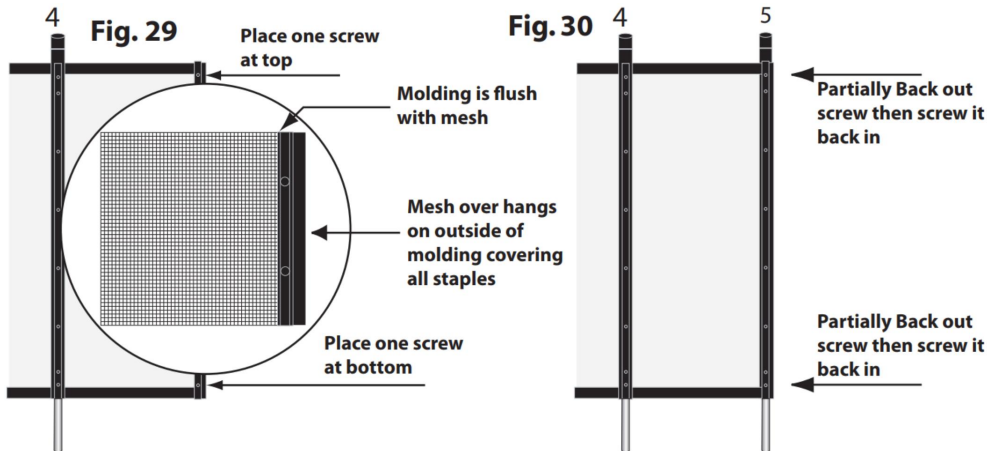

## Step 5: Finishing & Latching Your New Pool Fence D.I.Y.

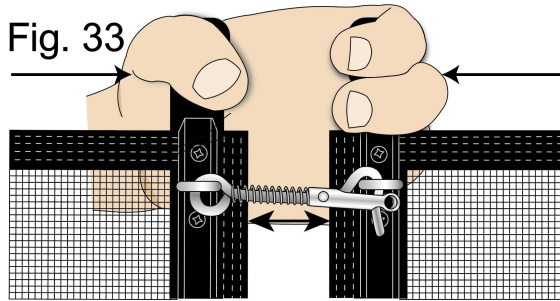

You must squeeze poles together and press the spring to remove and replace the latch.

**WARNING: THE POLE CANNOT BE REMOVED IF YOU SIMPLY PULL WITHOUT TURNING IT AT THE SAME TIME. IT IS IMPERATIVE THAT ACCESS POINTS ARE CLOSED AT THE END OF THE SEASON OF SUPERVISED SWIMMING.**

### 1. Maintenance

Try to regularly monitor all safety fence components. If any of the components should be damaged, especially those relating to closing, please contact the shop where you purchased the barrier immediately in order to obtain a replacement part. It is imperative to replace the elements or groups of elements that are damaged as soon as possible. Do not use parts that are not officially approved by the PROVIDER/ INSTALLER.

### SAFETY PRECAUTIONS

- THE SWIMMING POOL CAN BE A HAZARD TO YOUR CHILDREN. DROWNING MAY HAPPEN VERY QUICKLY. WHEN CHILDREN ARE NEAR THE POOL THEY REQUIRE CONSTANT AND ACTIVE SUPERVISION, EVEN IF THEY ARE ABLE TO SWIM.
- THIS BARRIER DOES NOT REPLACE COMMON SENSE OR INDIVIDUAL RESPONSIBILITY. THE BARRIER CANNOT REPLACE SUPERVISION CARRIED OUT BY RESPONSIBLE ADULTS WHICH STILL REMAINS THE KEY FACTOR IN PROTECTING SMALL CHILDREN.
- POINTS OF ACCESS MUST BE CLOSED SYSTEMATICALLY WHEN NO ONE IS HOME, EVEN IF IT IS FOR A SHORT PERIOD OF TIME.
- WARNING! SAFETY IS GUARANTEED ONLY WHEN POINTS OF ACCESS ARE LOCKED.

- CHECK WHETHER THERE ARE ELEMENTS NEAR THE BARRIER THAT COULD ENABLE OR FACILITATE CLIMBING THE FENCE.
- CLOSING POINTS OF ACCESS THROUGH AUTOMATED CLOSING SYSTEMS SHOULD BE CHECKED SYSTEMATICALLY.
- WHEN THE BARRIER IS BROKEN OR DAMAGED AND REQUIRES REPAIR WORK, IT IS VERY IMPORTANT TO INCREASE SUPERVISION TO PREVENT SMALL CHILDREN FROM ACCESSING THE POOL.



- LEARN RESCUE TECHNIQUES (CARDIOPULMONARY RESUSCITATION) AND UPDATE YOUR KNOWLEDGE PERIODICALLY. IT COULD SAVE A LIFE IN AN EMERGENCY.
- THE PRESENCE OF PARENTS AND/OR OTHER RESPONSIBLE ADULTS IS REQUIRED WHEN THE POOL IS ACCESSIBLE.

**MEMORIZE AND DISPLAY NEAR THE POOL THE FIRST AID NUMBERS.**

**FIREFIGHTERS**

**EMERGENCY MEDICAL SERVICES**

**POISON CONTROL CENTER**

Manufacturer: Shanghaimuxinmuyeyouxiangongsi

Address: Shuangchenglu 803nong11hao1602A-1609shi, baoshanqu, shanghai 200000 CN.

EC REP: E-CrossStu GmbH.

Mainzer Landstr.69, 60329 Frankfurt am Main.

UK REP: YH CONSULTING LIMITED.

C/O YH Consulting Limited Office 147, Centurion House, London Road, Staines-upon-Thames, Surrey, TW18 4AX

Imported to AUS: SIHAO PTY LTD.

1 ROKEVA STREET EASTWOOD NSW 2122 Australia

Imported to USA: Sanven Technology Ltd.

Suite 250, 9166 Anaheim Place, Rancho Cucamonga, CA 91730

**VEVOR<sup>®</sup>**

**TOUGH TOOLS, HALF PRICE**

**Technical Support and E-Warranty Certificate**

**[www.vevor.com/support](http://www.vevor.com/support)**