

# **VEVOR<sup>®</sup>**

## **TOUGH TOOLS, HALF PRICE**

Technical Support and E-Warranty Certificate [www.vevor.com/support](http://www.vevor.com/support)

## **LIVESTOCK TRIMMING STAND**

### **USER MANUAL**

We continue to be committed to provide you tools with competitive price.

"Save Half", "Half Price" or any other similar expressions used by us only represents an estimate of savings you might benefit from buying certain tools with us compared to the major top brands and does not necessarily mean to cover all categories of tools offered by us. You are kindly reminded to verify carefully when you are placing an order with us if you are actually saving half in comparison with the top major brands.

# VEVOR<sup>®</sup>

TOUGH TOOLS, HALF PRICE

## LIVESTOCK TRIMMING STAND

SCJ002-W / SCJ003-W / SCJ002-B / SCJ003-B



### NEED HELP? CONTACT US!

Have product questions? Need technical support? Please feel free to contact us:

**Technical Support and E-Warranty Certificate**  
[www.vevor.com/support](http://www.vevor.com/support)

This is the original instruction, please read all manual instructions carefully before operating. VEVOR reserves a clear interpretation of our user manual. The appearance of the product shall be subject to the product you received. Please forgive us that we won't inform you again if there are any technology or software updates on our product.

# Safety precautions

## WARNING:

**Read this instructions** before using this product. Failure to do so can result in serious injury. the basic precautions should always be followed,including the following:

1. The livestock trimming stand may not be used or stored in hazardous areas. It is not allowed to use the appliance in hazardous locations.
2. The livestock trimming stand must be checked to ensure that it is in proper working order and is operating safely prior to use. Otherwise,the appliance must not be used.
3. Use as intended only. The Livestock Trimming Stand needs to be placed on level ground for use. If necessary, the four feet can be secured with ground nails.
4. The operator must use the livestock trimming stand properly. He must consider the local conditions and must pay attention to third parties,in particular children,when working with the livestock trimming stand.
5. This livestock trimming stand is not intended for use by persons (including children) with reduced physical,sensory or mental abilities or lacking experience and/or knowledge,unless they are super- vised by a person responsible for their safety or are instructed by these persons on the use of the device. Children should be supervised,to ensure that they do not play with the livestock trimming stand.

**SAVE THESE INSTRUCTIONS**

# Product List

---

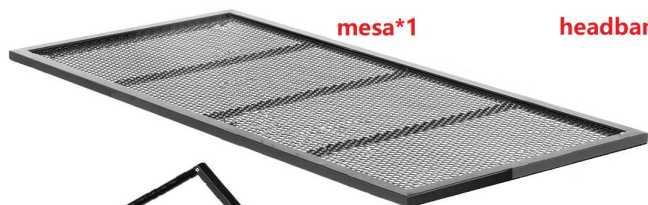

mesa\*1

headbands A\*1

upright poles \*1



headbands B\*1



triangular bracket \*1

fixed rods \*1



table legs\*2



Adjustable  
table legs\*2

chains \*1



bandage\*1



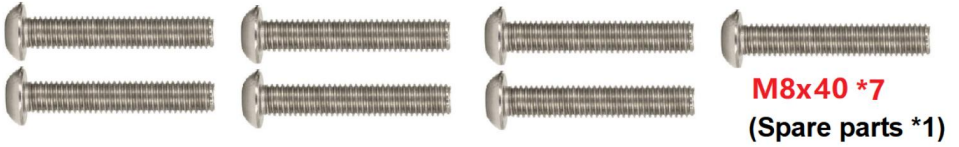

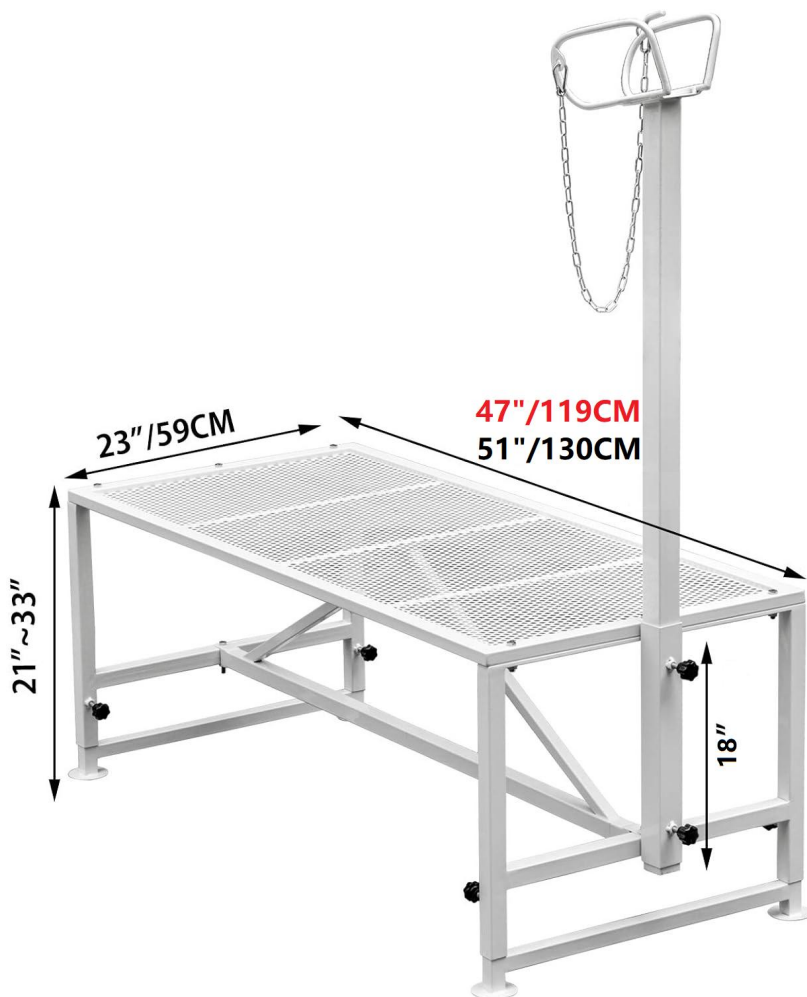

# Product Description

Model	Colour	Table size	Adjustable height of the countertop	The upright rod adjusts the height	weight capacity
<b>SCJ002-W</b>	white	47*23inch	I 21in/533mm;	18in/457mm	500lbs
<b>SCJ003-W</b>	white	51*23inch	II 25in/635mm;		
<b>SCJ002-B</b>	black	47*23inch	III 29in/736mm;		
<b>SCJ003-B</b>	black	51*23inch	IV 33in/838mm;		



# Installation Steps

Parts	Explanatory Chart
<p>table legs *2</p> <p>adjustable table legs *2</p> <p>plastic knobs *2</p>	 <ol style="list-style-type: none"><li data-bbox="258 839 852 868">1. Insert the adjustable table leg into the table leg.</li><li data-bbox="258 879 777 908">2. Secure the table leg with 2 plastic knobs.</li></ol>
<p>M8x40 *5</p> <p>M8 *5</p>	 <ol style="list-style-type: none"><li data-bbox="258 1385 891 1414">1. Support the countertop with assembled table legs.</li><li data-bbox="258 1425 1031 1495">2. Thread 5 M8x35 holes through the table top, attach small spacers, and secure them with nuts.</li></ol>

fixed rods \*1

M8x40 \*1

M8 \*1



1. Jam the countertop with fixed rods and align the holes.
2. Thread 1 M8x40 through the hole of the fixed rods, attach the small spacer, and secure it with a nut.

triangular  
bracket \*1

M8x40 \*1

M8 \*1

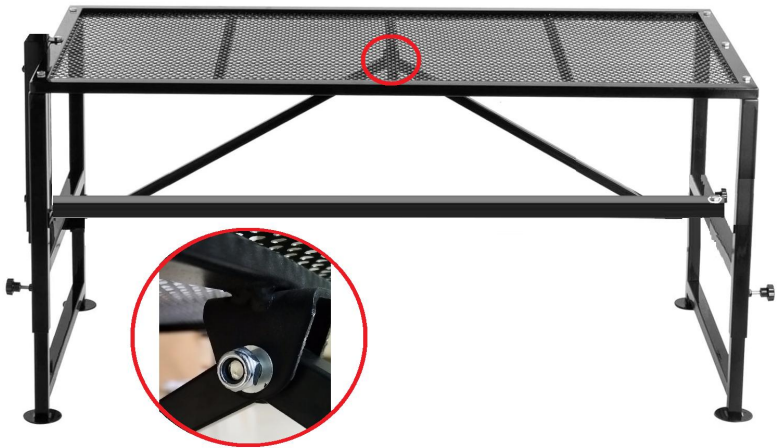

Thread 1 M8x40 screw through the middle hole of the triangle bracket and secure with spacers and nuts.



M8x80 \*2

big gasket \*2

M8 \*2

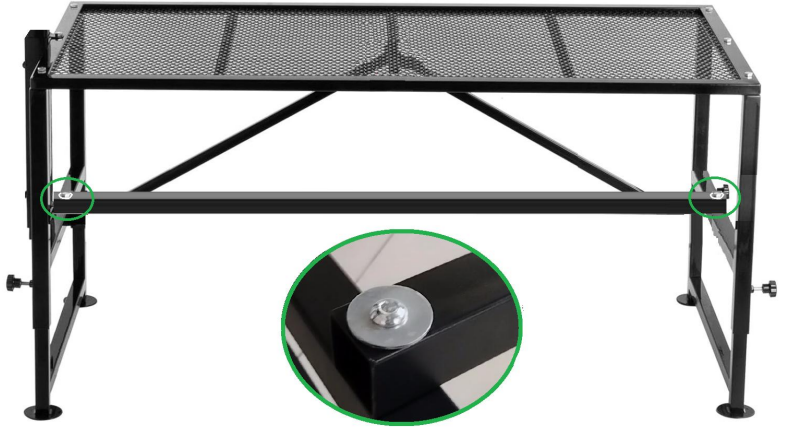

Thread 2 M8x80 screws through the large spacer, then through the holes on both sides of the triangle bracket and secure with the spacer and nut.

upright poles  
\*1

plastic  
knobs \*2

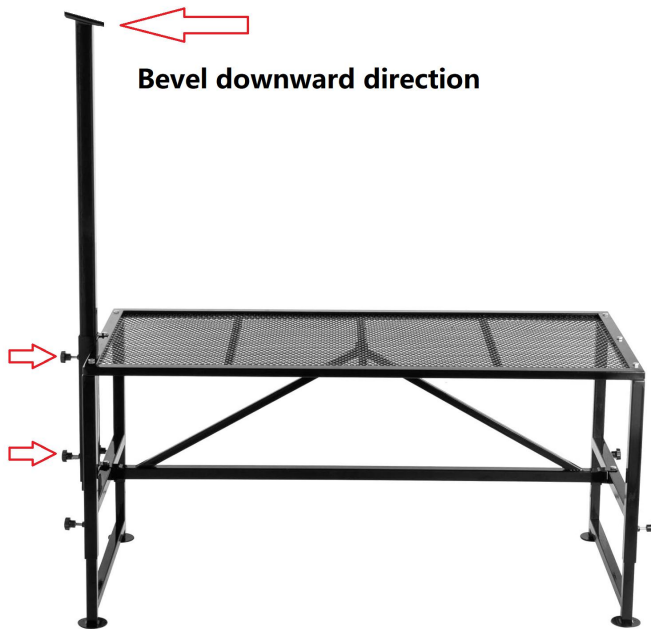

1. Insert the upright poles into the fixed rods square hole in the downward direction of the bevel.
2. Secure the upright poles with 2 plastic knobs.

headbands

A \*1

headbands

B \*1

M6x20 \*4

M6 \*4

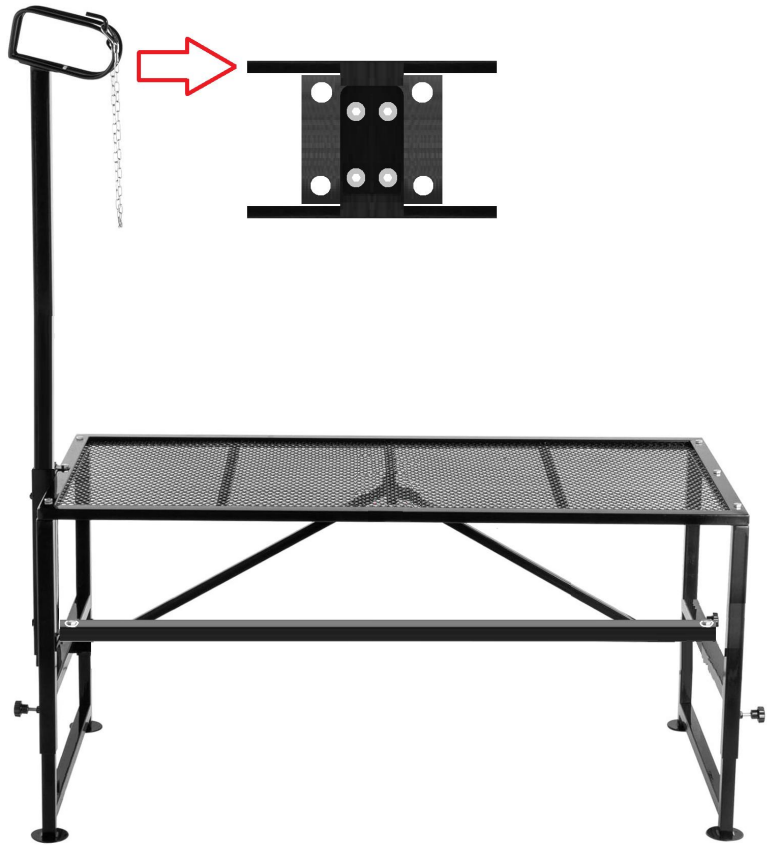

1. Put the headbands B first.
1. Then put the headbands A.
2. Fix the headbands with 4 M6x20 screws.
3. Tighten the locking screws with 4 M6 nuts.

# Product Usage

The height of the table corresponding to the four bolt hole gears.

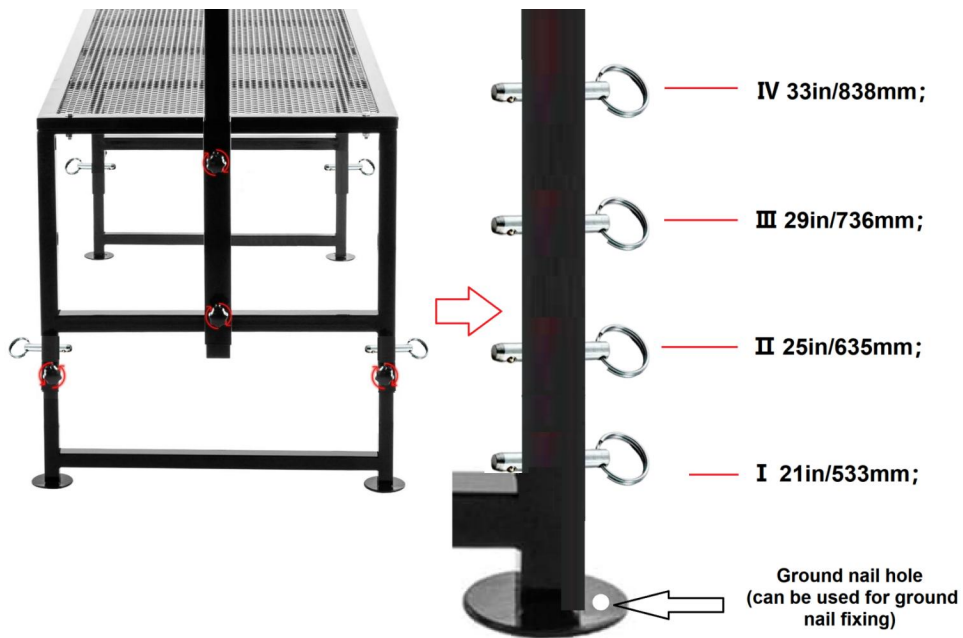

**Manufacturer:**Shanghaimuxinmuyeyouxiangongsi

**Address:** Shuangchenglu 803nong11hao1602A-1609shi, baoshanqu, shanghai 200000 CN.

**Imported to AUS:** SIHAO PTY LTD. 1 ROKEVA STREETEASTWOOD NSW 2122 Australia

**Imported to USA:** Sanven Technology Ltd. Suite 250, 9166 Anaheim Place, Rancho Cucamonga, CA 91730

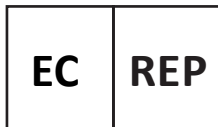

E-CrossStu GmbH

Mainzer Landstr.69, 60329 Frankfurt am Main.



YH CONSULTING LIMITED.

C/O YH Consulting Limited Office 147, Centurion House,  
London Road, Staines-upon-Thames, Surrey, TW18 4AX

# VEVOR®

**TOUGH TOOLS, HALF PRICE**

**Technical Support and E-Warranty Certificate**

[www.vevor.com/support](http://www.vevor.com/support)