

VEVOR[®]

TOUGH TOOLS, HALF PRICE

Technical Support and E-Warranty Certificate www.vevor.com/support

METAL EDGING USER MANUAL

We continue to be committed to provide you tools with competitive price.

"Save Half", "Half Price" or any other similar expressions used by us only represents an estimate of savings you might benefit from buying certain tools with us compared to the major top brands and does not necessarily mean to cover all categories of tools offered by us. You are kindly reminded to verify carefully when you are placing an order with us if you are actually saving half in comparison with the top major brands.

VEVOR®

TOUGH TOOLS, HALF PRICE

METAL EDGING

Model:JC40*6in 3pcs, JC40*8in 3pcs, JC40*6in 4pcs, JC40*8in 4pcs,
JC40*6in 6pcs, JC40*8in 6pcs, JC12*40in 4pcs

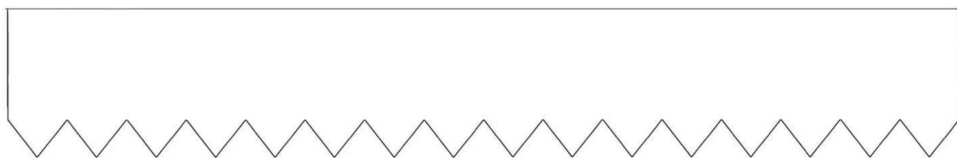

NEED HELP? CONTACT US!

Have product questions? Need technical support? Please feel free to contact us:

Technical Support and E-Warranty Certificate
www.vevor.com/support

This is the original instruction, please read all manual instructions carefully before operating. VEVOR reserves a clear interpretation of our user manual. The appearance of the product shall be subject to the product you received. Please forgive us that we won't inform you again if there are any technology or software updates on our product.



Safety & Warning

- Read and understand this entire manual before assembling, installing, operating, or servicing this product. Failure to follow these warnings and instructions can cause death, personal injury or damage to valuable property.
- Wear ANSI-approved safety goggles, heavy-duty work gloves and safety shoes during assembly and installation of this product. Keep bystanders out of the area during assembly
- Do not assemble when tired or when under the influence of alcohol, drugs or medication.
- Use as intended only. **TO PREVENT SERIOUS INJURY AND DEATH FROM TIPPING: DO NOT SIT, STAND OR CLIMB ON THIS ITEM.**
- **This product is not a toy. Do not allow children to play with or near this item.**
- Before use, inspect the general condition of the product. Check for: broken, cracked, or bent parts, loose or missing parts, and any condition that may affect the proper function of the product.
- Ensure only genuine parts are used for replacement & Repair.

SAVE THESE INSTRUCTIONS

SPECIFICATIONS

Model	JC40*6in 3pcs
Size of Single metal edge	40*6in
Color	Black

Model	JC40*8in 3pcs
Size of Single metal edge	40*8in
Color	Black

Model	JC40*6in 4pcs
Size of Single metal edge	40*6in
Color	Black



Model	JC40*8in 4pcs
Size of Single metal edge	40*6in
Color	Black

Model	JC40*6in 6pcs
Size of Single metal edge	40*6in
Color	Black

Model	JC40*8in 6pcs
Size of Single metal edge	40*8in
Color	Black

Model	JC12*40in 4pcs
Size of Single metal edge	40*12in
Color	Black

COMPONENTS

Model			
	Metal edge	Connector	Gloves
JC40*6 in 3pcs	x3	x5	X1
JC40*8in 3pcs	x3	x5	
JC40*6in 4pcs	x4	x6	
JC40*8in 4pcs	x4	x6	
JC40*6in 6pcs	x6	x8	
JC40*8in 6pcs	x6	x8	
JC12*40in 4pcs	x4	x6	

Required tools

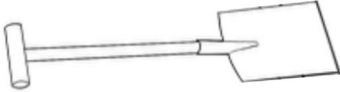
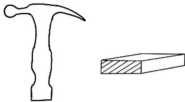
1.Spade	
2.Hammer and a block of wood	

Assemble instructions

STEP 1 Prepare a line for the edging to follow and remove any obstructions. If ground is stony,loosen with pickaxe.

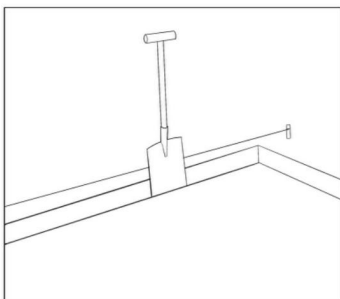

STEP 2 Bending instructions: A work bench, the edge of a table, a timber, or other former is advised when bending the metal edge to required angle.

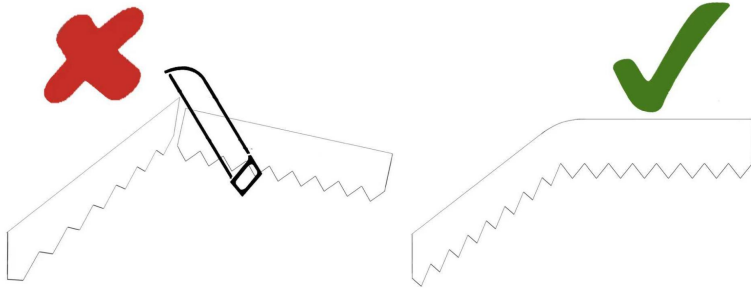
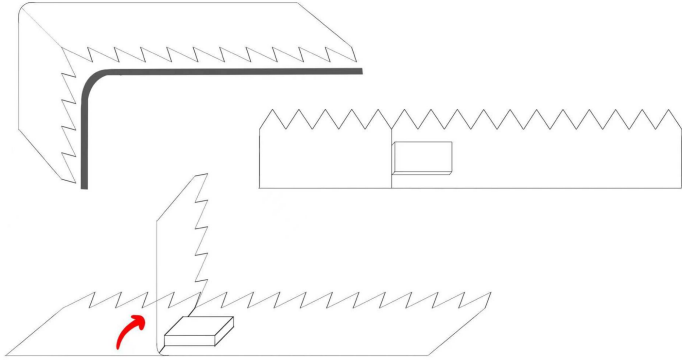

NOTE: Do not cut with anything as it can cause injury.

STEP:3 Insert the connected metal edges into the ground and secure it with a hammer.

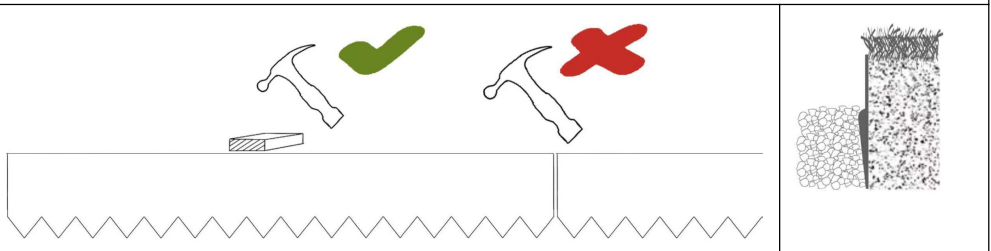

NOTE:Place a piece of wood over the metal edge when striking with a hammer to avoid damaging the metal edge.

STEP:4 Insert a connector to fix the connection.

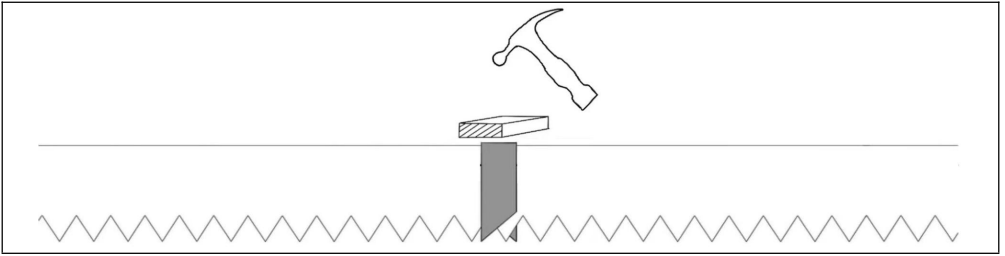

Supplementary statement: The metal barrier can be bent into the shape you need according to your needs (Including but not limited to the following shapes).

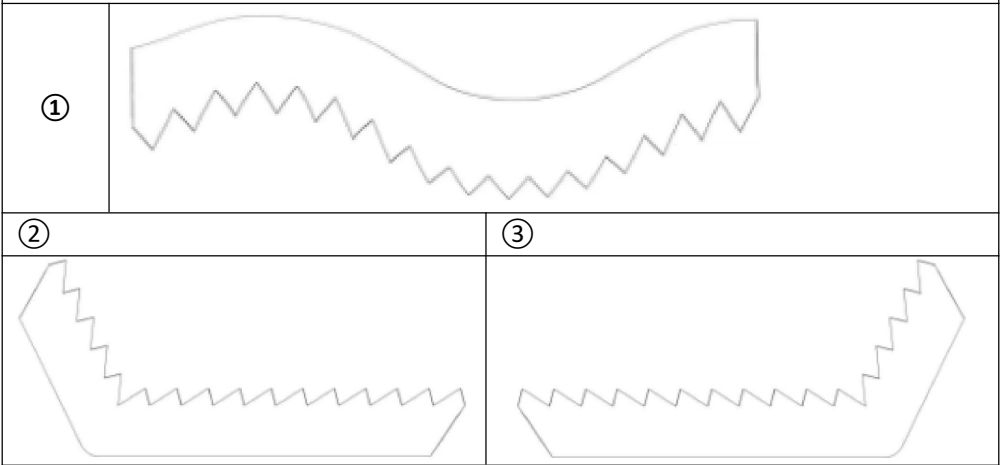

Address: Baoshanqu Shuangchenglu 803long 11hao 1602A-1609shi Shanghai

Imported to AUS: SIHAO PTY LTD, 1 ROKEVA STREETEASTWOOD NSW 2122 Australia

Imported to USA: Sanven Technology Ltd.Suite 250, 9166 Anaheim Place, Rancho Cucamonga, CA 91730

EC	REP	SHUNSHUN GmbH Römeräcker 9 Z2021,76351 Linkenheim-Hochstetten, Germany
-----------	------------	--

UK	REP	Pooledas Group Ltd Unit 5 Albert Edward House, The Pavilions Preston, United Kingdom
-----------	------------	--

Made In China

VEVOR[®]

TOUGH TOOLS, HALF PRICE

Technical Support and E-Warranty Certificate

www.vevor.com/support

VEVOR[®]

TOUGH TOOLS, HALF PRICE

Técnico Soporte y certificado de garantía electrónica www.vevor.com/support

BORDE METÁLICO MANUAL DE USUARIO

We continue to be committed to provide you tools with competitive price.

"Save Half", "Half Price" or any other similar expressions used by us only represents an estimate of savings you might benefit from buying certain tools with us compared to the major top brands and does not necessarily mean to cover all categories of tools offered by us. You are kindly reminded to verify carefully when you are placing an order with us if you are actually saving half in comparison with the top major brands.

VEVOR®

TOUGH TOOLS, HALF PRICE

METAL EDGING

Modelo: JC40*6 pulgadas 3 piezas , JC40* 8 pulgadas 3 piezas , JC40* 6 pulgadas 4 piezas , JC40* 8 pulgadas 4 piezas , JC40* 6 pulgadas 6 piezas , JC40* 8 pulgadas 6 piezas , JC12*40 pulgadas 4 piezas

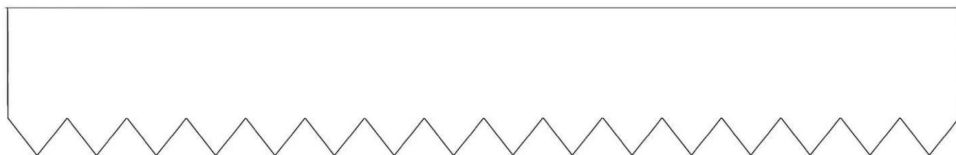

NEED HELP? CONTACT US!

Have product questions? Need technical support? Please feel free to contact us:

Technical Support and E-Warranty Certificate
www.vevor.com/support

This is the original instruction, please read all manual instructions carefully before operating. VEVOR reserves a clear interpretation of our user manual. The appearance of the product shall be subject to the product you received. Please forgive us that we won't inform you again if there are any technology or software updates on our product.



Advertencia de seguridad

- Lea y comprenda este manual completo antes de ensamblar, instalar, operar o dar servicio a este producto. El incumplimiento de estas advertencias e instrucciones puede provocar la muerte, lesiones personales o daños a bienes valiosos.
- Utilice gafas de seguridad, guantes de trabajo resistentes y calzado de seguridad aprobados por ANSI durante el montaje e instalación de este producto. Mantenga a los transeúntes fuera del área durante el montaje.
- No se reúna cuando esté cansado o bajo la influencia de alcohol, drogas o medicamentos.
- Úselo únicamente según lo previsto. **PARA EVITAR LESIONES GRAVES O LA MUERTE POR VUELCO: NO SE SIENTE, PARE NI SE SUBA SOBRE ESTE ARTÍCULO.**
- **Este producto no es un juguete. No permita que los niños jueguen con este artículo o cerca de él.**
- Antes de su uso, inspeccionar el estado general del producto. Verifique: piezas rotas, agrietadas o dobladas, piezas sueltas o faltantes y cualquier condición que pueda afectar el funcionamiento adecuado del producto.
- Asegúrese de que solo se utilicen piezas originales para el reemplazo y la reparación.

GUARDA ESTAS INSTRUCCIONES

ESPECIFICACIONES

Modelo	JC40 * 6 pulgadas 3 piezas
Tamaño del borde metálico único	40*6 pulgadas
Color	Negro

Modelo	JC40* 8 en 3 piezas
Tamaño del borde metálico único	40*8 pulgadas
Color	Negro

Modelo	JC40*6 pulgadas 4 piezas
Tamaño del borde metálico único	40*6 pulgadas
Color	Negro

Modelo	JC40* 8 en 4 piezas
Tamaño del borde metálico único	40*6 pulgadas
Color	Negro



Modelo	JC40*6 pulgadas 6 piezas
--------	--------------------------

Tamaño del borde metálico único	40*6 pulgadas
Color	Negro

Modelo	JC40* 8 en 6 piezas
Tamaño del borde metálico único	40*8 pulgadas
Color	Negro

Modelo	JC12 * 40 pulgadas 4 piezas
Tamaño del borde metálico único	40*12 pulgadas
Color	Negro

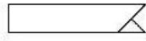
COMPONENTES

Modelo			
	Borde metálico	Conector	Guantes
JC40*6 en 3 piezas	x3 _	x5 _	X1 _
JC40 * 8 pulgadas 3 piezas	x3	x5	
JC40* 6 en 4 piezas	x4	x6	
JC40*8 pulgadas 4 piezas	x4 _	x6 _	

JC40*6 pulgadas 6 piezas	x6 _	x8 _	
JC40*8 pulgadas 6 piezas	x6 _	x8 _	
JC12*40 pulgadas 4 piezas	x4 _	x6 _	

Herramientas necesarias

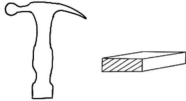
1. pala	
2. Martillo y un bloque de madera.	

Instrucciones de montaje

PASO 1 Prepare una línea para que la siga el borde y elimine cualquier obstrucción. Si el terreno es pedregoso, afloje con un pico.

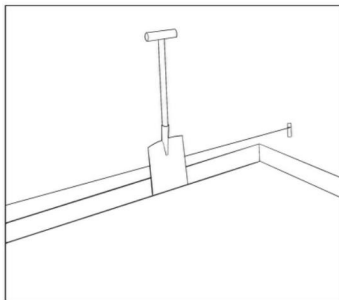

PASO 2 Instrucciones para doblar : Se recomienda utilizar un banco de trabajo, el borde de una mesa, una madera u otro material para doblar el borde de metal al ángulo requerido.

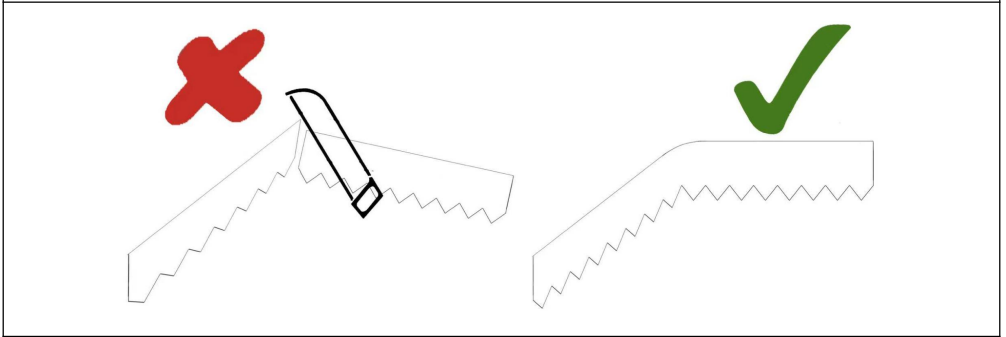
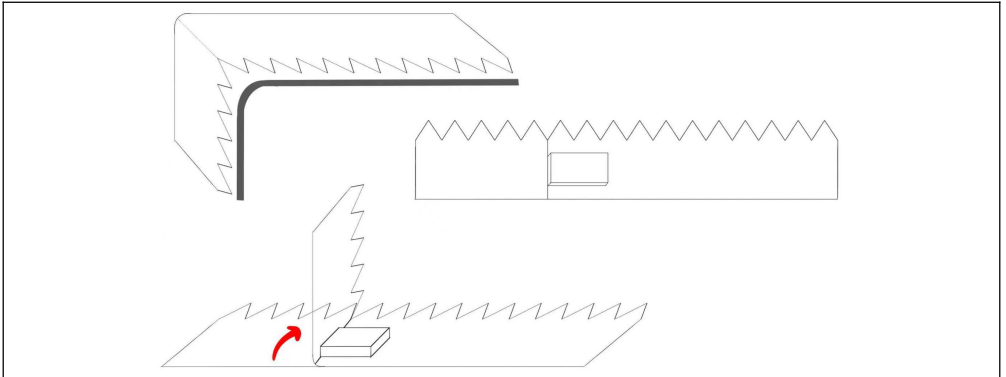

NOTA: No corte con nada ya que puede causar lesiones .

PASO:3 Inserte los bordes metálicos conectados en el suelo y asegúrelos con un martillo.

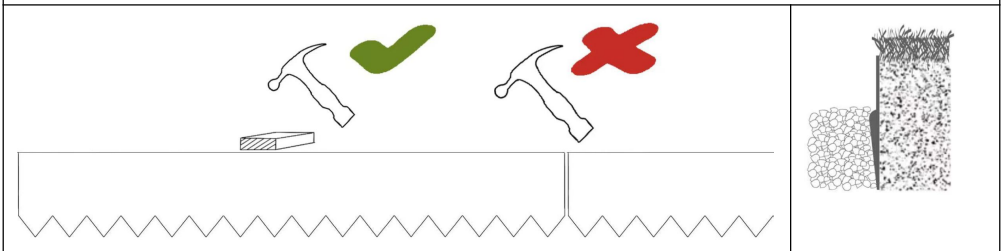

NOTA: Coloque un trozo de madera sobre el borde metálico cuando golpee con un martillo para evitar dañar el borde metálico.

PASO:4 Inserte un conector para fijar la conexión.

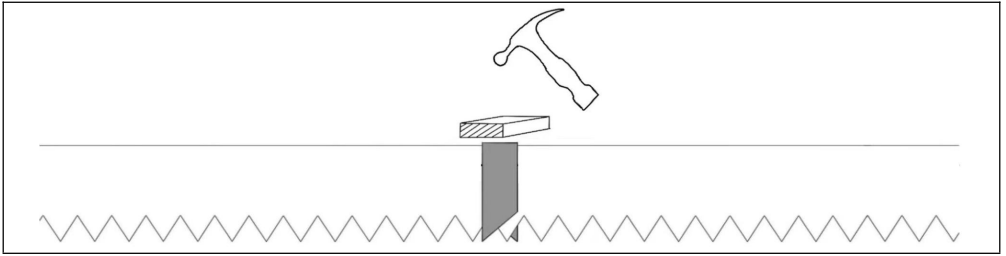

Declaración complementaria : La barrera metálica se puede doblar en la forma que necesite según sus necesidades (incluidas, entre otras, las siguientes formas).

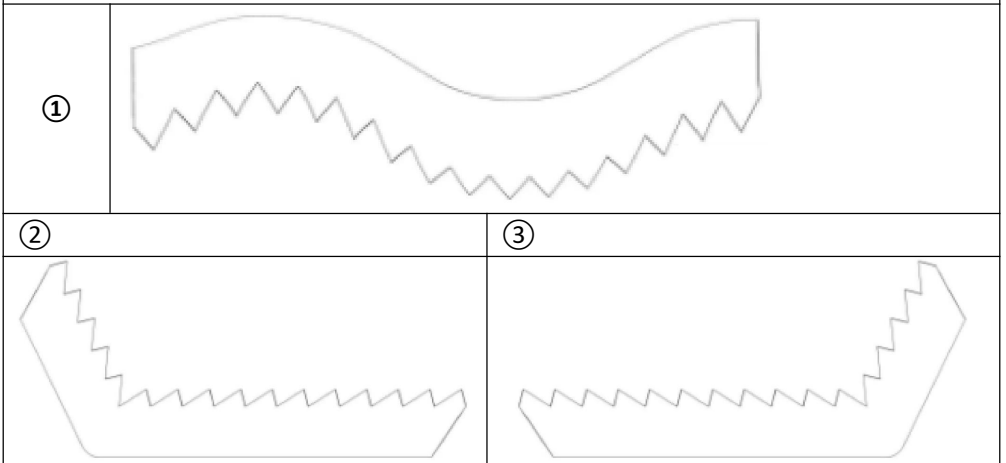

Dirección: Baoshanqu Shuangchenglu 803long 11hao 1602A-1609shi Shanghai

Importado a AUS: SIHAO PTY LTD, 1 ROKEVA STREETEASTWOOD NSW 2122 Australia

Importado a EE. UU.: Sanven Technology Ltd.Suite 250, 9166 Anaheim Place, Rancho Cucamonga, CA 91730

EC	REP	SHUNSHUN GmbH Römeräcker 9 Z2021,76351 Linkenheim-Hochstetten, Germany
-----------	------------	--

UK	REP	Pooledas Group Ltd Unit 5 Albert Edward House, The Pavilions Preston, United Kingdom
-----------	------------	--

Hecho en china

VEVOR[®]

TOUGH TOOLS, HALF PRICE

Técnico Certificado de soporte y garantía electrónica

www.vevor.com/support

VEVOR[®]

TOUGH TOOLS, HALF PRICE

Tecnico Supporto e certificato di garanzia elettronica www.vevor.com/support

BORDO IN METALLO MANUALE D'USO

We continue to be committed to provide you tools with competitive price.

"Save Half", "Half Price" or any other similar expressions used by us only represents an estimate of savings you might benefit from buying certain tools with us compared to the major top brands and does not necessarily mean to cover all categories of tools offered by us. You are kindly reminded to verify carefully when you are placing an order with us if you are actually saving half in comparison with the top major brands.

VEVOR[®]

TOUGH TOOLS, HALF PRICE

METAL EDGING

Modello: JC40*6in 3 pezzi , JC40* 8 in 3 pezzi , JC40*6in 4 pezzi , JC40* 8 in 4 pezzi , JC40*6in 6 pezzi , JC40* 8 in 6 pezzi , JC12*40in 4 pezzi

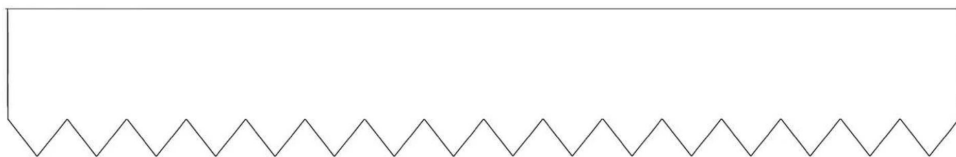

NEED HELP? CONTACT US!

Have product questions? Need technical support? Please feel free to contact us:

Technical Support and E-Warranty Certificate
www.vevor.com/support

This is the original instruction, please read all manual instructions carefully before operating. VEVOR reserves a clear interpretation of our user manual. The appearance of the product shall be subject to the product you received. Please forgive us that we won't inform you again if there are any technology or software updates on our product.

Avvertenza di sicurezza

- Leggere e comprendere l'intero manuale prima di assemblare, installare, utilizzare o sottoporre a manutenzione questo prodotto. La mancata osservanza di queste avvertenze e istruzioni può causare morte, lesioni personali o danni a beni di valore.
- Indossare occhiali di sicurezza approvati ANSI, guanti da lavoro pesanti e scarpe di sicurezza durante il montaggio e l'installazione di questo prodotto. Tenere gli astanti lontani dall'area durante il montaggio
- Non montare in caso di stanchezza o sotto l'effetto di alcol, droghe o farmaci.
- Utilizzare solo come previsto. **PER EVITARE LESIONI GRAVI E MORTE DOVUTE AL RIBALTAMENTO: NON SEDERSI, NON STARE IN PIEDI O ARRAMPICARSI SU QUESTO OGGETTO.**
- **Questo prodotto non è un giocattolo. Non permettere ai bambini di giocare con o vicino a questo oggetto.**
- Prima dell'uso, ispezionare le condizioni generali del prodotto. Verificare la presenza di: parti rotte, incrinare o piegate, parti allentate o mancanti e qualsiasi condizione che possa influire sul corretto funzionamento del prodotto.
- Assicurarsi che per la sostituzione e la riparazione vengano utilizzate solo parti originali.

CONSERVA QUESTE ISTRUZIONI

SPECIFICHE

Modello	JC40*6 pollici 3 pezzi
Dimensioni del bordo metallico singolo	40*6 pollici
Colore	Nero

Modello	JC40* 8 pollici 3 pezzi
Dimensioni del bordo metallico singolo	40*8 pollici
Colore	Nero

Modello	JC40*6 pollici 4 pz
Dimensioni del bordo metallico singolo	40*6 pollici
Colore	Nero

Modello	JC40* 8 pollici 4 pz
Dimensioni del bordo metallico singolo	40*6 pollici
Colore	Nero



Modello	JC40*6 pollici 6 pezzi
Dimensioni del bordo metallico singolo	40*6 pollici
Colore	Nero

Modello	JC40* 8 pollici 6 pz
Dimensioni del bordo metallico	40*8 pollici

singolo	
Colore	Nero

Modello	JC12*40 pollici 4 pezzi
Dimensioni del bordo metallico singolo	40*12 pollici
Colore	Nero

COMPONENTI

Modello			
	Bordo in metallo	Connettore	Guanti
JC40*6 in 3 pezzi	x3 _	x5 _	X1 _
JC40*8 pollici 3 pezzi	x3	x5	
JC40* 6 pollici 4 pezzi	x4	x6	
JC40*8 pollici 4 pezzi	x4 _	x6 _	
JC40*6 pollici 6 pezzi	x6 _	x8 _	
JC40*8 pollici 6 pezzi	x6 _	x8 _	
JC12*40 pollici 4 pezzi	x4 _	x6 _	

Strumenti richiesti

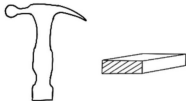
1. Vanga	
2. Martello e un blocco di legno	

Istruzioni per il montaggio

FASE 1 Preparare una linea da seguire per il bordo e rimuovere eventuali ostruzioni. Se il terreno è sassoso, allentare con il piccone.

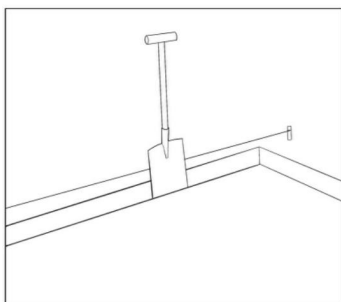

FASE 2 Istruzioni per la piegatura : si consiglia di utilizzare un banco da lavoro, il bordo di un tavolo, una tavola di legno o altro per piegare il bordo metallico all'angolazione richiesta.

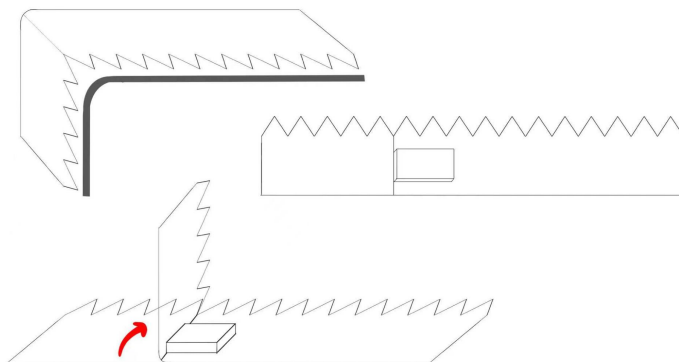

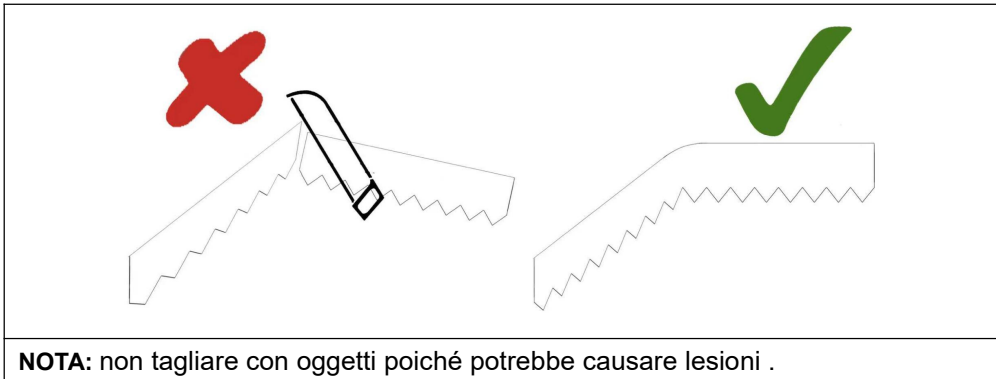

PASSO:3 Inserisci i bordi metallici collegati nel terreno e fissali con un martello.

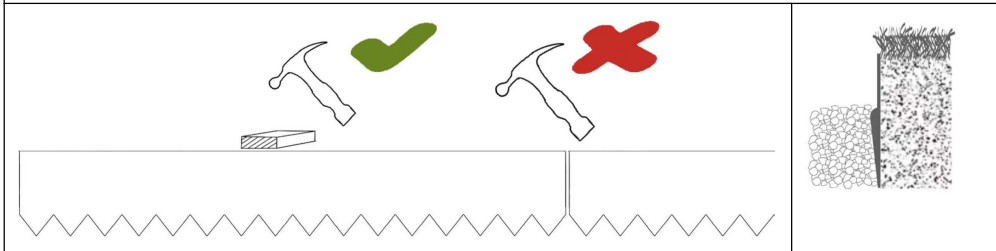

PASSO:4 Inserisci un connettore per fissare la connessione.

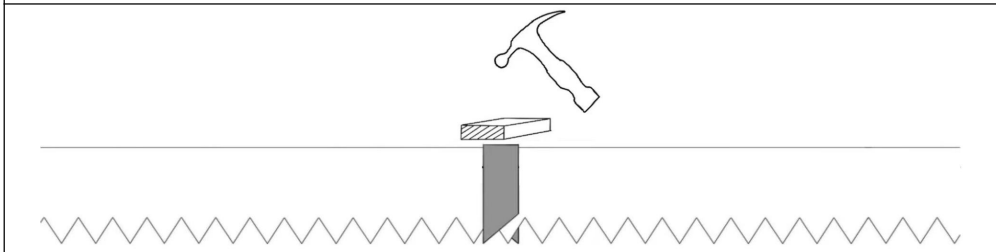

Dichiarazione supplementare : la barriera metallica può essere piegata nella forma desiderata in base alle proprie esigenze (comprese ma non limitate alle seguenti forme).

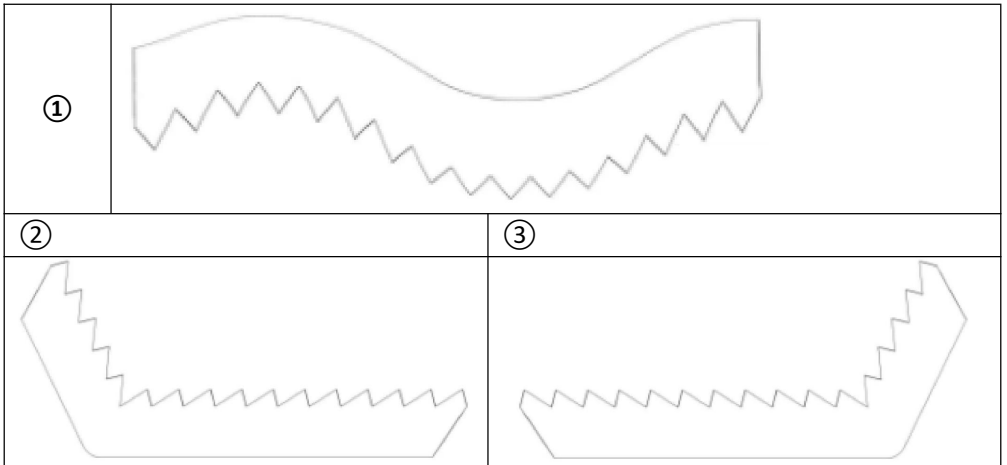

Indirizzo: Baoshanqu Shuangchenglu 803long 11hao 1602A-1609shi Shanghai

Importato in AUS: SIHAO PTY LTD, 1 ROKEVA STREETEASTWOOD NSW 2122
Australia

Importato negli Stati Uniti: Sanven Technology Ltd.Suite 250, 9166 Anaheim Place,
Rancho Cucamonga, CA 91730

EC	REP	SHUNSHUN GmbH Römeräcker 9 Z2021,76351 Linkenheim-Hochstetten, Germany
-----------	------------	--

UK	REP	Pooledas Group Ltd Unit 5 Albert Edward House, The Pavilions Preston, United Kingdom
-----------	------------	--

Made in China

VEVOR[®]

TOUGH TOOLS, HALF PRICE

Tecnico Supporto e certificato di garanzia elettronica

www.vevor.com/support

VEVOR[®]

TOUGH TOOLS, HALF PRICE

Techniczny Certyfikat wsparcia i e-gwarancji www.vevor.com/support

OBRZEŻE METALOWE INSTRUKCJA OBSŁUGI

We continue to be committed to provide you tools with competitive price.

"Save Half", "Half Price" or any other similar expressions used by us only represents an estimate of savings you might benefit from buying certain tools with us compared to the major top brands and does not necessarily mean to cover all categories of tools offered by us. You are kindly reminded to verify carefully when you are placing an order with us if you are actually saving half in comparison with the top major brands.

VEVOR®

TOUGH TOOLS, HALF PRICE

METAL EDGING

Model: JC40*6 cali 3 szt. , JC40* 8 cali 3 szt . , JC40*6 cali 4 szt. , JC40* 8 cali 4 szt. , JC40*6 cali 6 szt . , JC40* 8 cali 6 szt ., JC12*40in 4 szt.

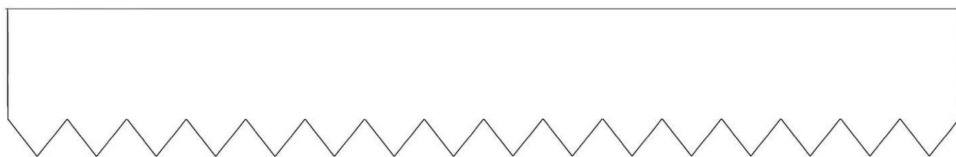

NEED HELP? CONTACT US!

Have product questions? Need technical support? Please feel free to contact us:

Technical Support and E-Warranty Certificate
www.vevor.com/support

This is the original instruction, please read all manual instructions carefully before operating. VEVOR reserves a clear interpretation of our user manual. The appearance of the product shall be subject to the product you received. Please forgive us that we won't inform you again if there are any technology or software updates on our product.

Bezpieczeństwo i ostrzeżenie

- Przeczytaj i zrozum całą niniejszą instrukcję przed montażem, instalacją, obsługą lub serwisowaniem tego produktu. Niezastosowanie się do tych ostrzeżeń i instrukcji może spowodować śmierć, obrażenia ciała lub uszkodzenie cennego mienia.
- Podczas montażu i instalacji tego produktu należy nosić zatwierdzone przez ANSI okulary ochronne, wytrzymałe rękawice robocze i obuwie ochronne. Podczas montażu trzymaj osoby postronne z dala od obszaru
- Nie należy montować, gdy jest się zmęczonym lub pod wpływem alkoholu, narkotyków lub leków.
- Używaj wyłącznie zgodnie z przeznaczeniem. **ABY UNIKNĄĆ POWAŻNYCH OBRAŻEŃ LUB ŚMIERCI W PRZYPADKU WYWROTU: NIE SIDŹ, NIE STÓJ ANI WSPIERAJ SIĘ NA TYM PRZEDMIOCIE.**
- **Ten produkt nie jest zabawką. Nie pozwalaj dzieciom bawić się tym przedmiotem lub w jego pobliżu.**
- Przed użyciem należy sprawdzić ogólny stan produktu. Sprawdź, czy nie ma złamanych, pękniętych lub wygiętych części, luźnych lub brakujących części oraz wszelkich stanów, które mogą mieć wpływ na prawidłowe funkcjonowanie produktu.
- Upewnij się, że do wymiany i naprawy używane są wyłącznie oryginalne części.

ZACHOWAJ TE INSTRUKCJE

SPECYFIKACJE

Model	JC40*6 cali 3 szt
Rozmiar pojedynczej metalowej krawędzi	40*6 cali
Kolor	Czarny

Model	JC40* 8 w 3szt
Rozmiar pojedynczej metalowej krawędzi	40*8 cali
Kolor	Czarny

Model	JC40*6 cali 4 szt
Rozmiar pojedynczej metalowej krawędzi	40*6 cali
Kolor	Czarny

Model	JC40* 8 w 4 szt
Rozmiar pojedynczej metalowej krawędzi	40*6 cali
Kolor	Czarny



Model	JC40*6 cali 6 szt
Rozmiar pojedynczej metalowej krawędzi	40*6 cali
Kolor	Czarny

Model	JC40* 8 w 6 szt
Rozmiar pojedynczej	40*8 cali

metalowej krawędzi	
Kolor	Czarny

Model	JC12*40 cali 4szt
Rozmiar pojedynczej metalowej krawędzi	40*12 cali
Kolor	Czarny

SKŁADNIKI

Model			
	Metalowa krawędź	Złącze	Rękawice
JC40*6 w 3szt	x 3	x 5	X 1
JC40*8 cali 3szt	x3	x5	
JC40* 6 w 4szt	x4	x6	
JC40*8 cali 4 szt	x 4	x 6	
JC40*6 cali 6 szt	x 6	x 8	
JC40*8 cali 6 szt	x 6	x 8	
JC12*40 cali 4 szt	x 4	x 6	

Wymagane narzędzia

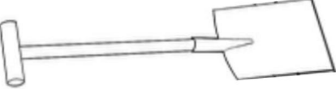
1. Łopata	
-----------	---

2. Młotek i klocek drewna

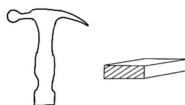

Instrukcje montażu

KROK 1 Przygotuj linię, po której będzie przebiegać obrzeże i usuń wszelkie przeszkody. Jeśli ziemia jest kamienista, poluzuj ją kilofem.

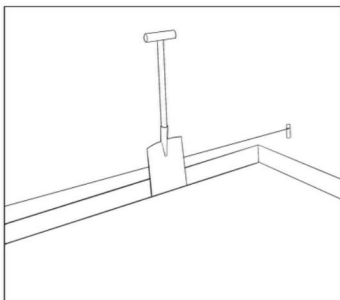

KROK 2 Instrukcje dotyczące gięcia : Do zginania metalowej krawędzi pod wymaganym kątem zaleca się stół warsztatowy, krawędź stołu, drewno lub inną deskę.

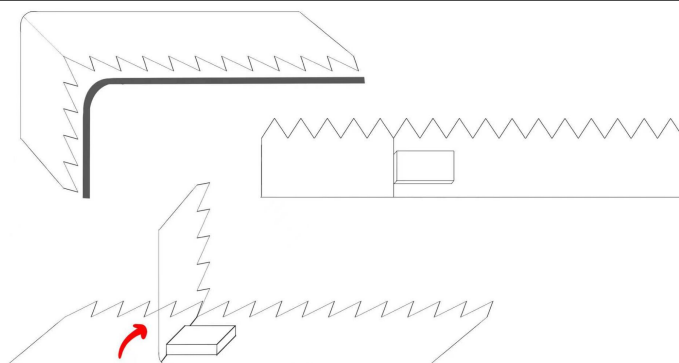

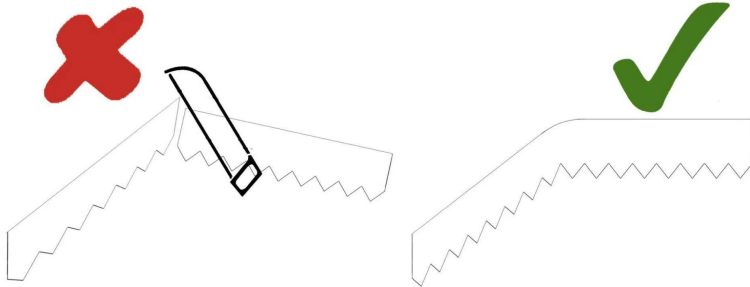

UWAGA: Nie przecinaj niczym, ponieważ może to spowodować obrażenia .

KROK:3 Wbij połączone metalowe krawędzie w ziemię i zabezpiecz młotkiem.

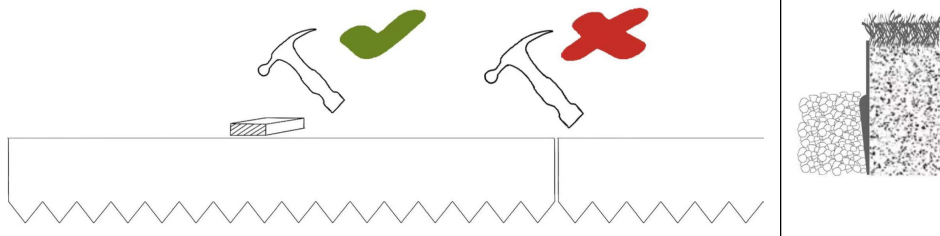

UWAGA: Podczas uderzania młotkiem umieść kawałek drewna na metalowej krawędzi, aby uniknąć uszkodzenia metalowej krawędzi.

KROK:4 Włóż złącze, aby naprawić połączenie.

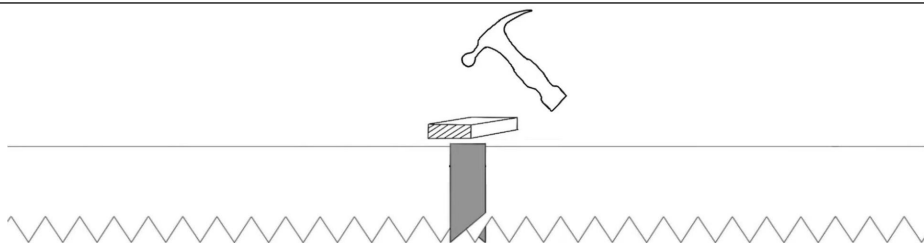

Oświadczenie uzupełniające : Metalową barierę można wygiąć do wymaganego kształtu, zgodnie z własnymi potrzebami (w tym między innymi następujące kształty).

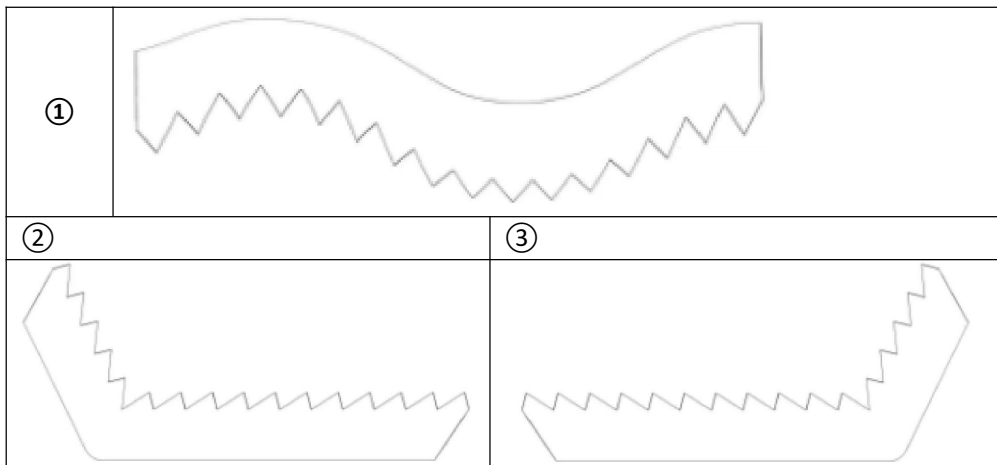

Adres: Baoshanqu Shuangchenglu 803long 11hao 1602A-1609shi Szanghaj

Import do AUS: SIHAO PTY LTD, 1 ROKEVA STREETEASTWOOD NSW 2122 Australia

Import do USA: Sanven Technology Ltd.Suite 250, 9166 Anaheim Place, Rancho Cucamonga, CA 91730

EC	REP	SHUNSHUN GmbH Römeräcker 9 Z2021,76351 Linkenheim-Hochstetten, Germany
-----------	------------	--

UK	REP	Pooledas Group Ltd Unit 5 Albert Edward House, The Pavilions Preston, United Kingdom
-----------	------------	--

Wyprodukowano w Chinach

VEVOR[®]

TOUGH TOOLS, HALF PRICE

Techniczny Certyfikat wsparcia i e-gwarancji

www.vevor.com/support

VEVOR[®]

TOUGH TOOLS, HALF PRICE

Technisch Support- und E-Garantie-Zertifikat www.vevor.com/support

METALLKANTE BENUTZERHANDBUCH

We continue to be committed to provide you tools with competitive price.

"Save Half", "Half Price" or any other similar expressions used by us only represents an estimate of savings you might benefit from buying certain tools with us compared to the major top brands and does not necessarily mean to cover all categories of tools offered by us. You are kindly reminded to verify carefully when you are placing an order with us if you are actually saving half in comparison with the top major brands.

VEVOR®

TOUGH TOOLS, HALF PRICE

METAL EDGING

Modell: JC40*6 Zoll 3 Stück , JC40* 8 Zoll 3 Stück , JC40* 6 Zoll 4 Stück ,
JC40* 8 Zoll 4 Stück , JC40*6 Zoll 6 Stück , JC40* 8 Zoll 6 Stück , JC12*40
Zoll 4 Stück

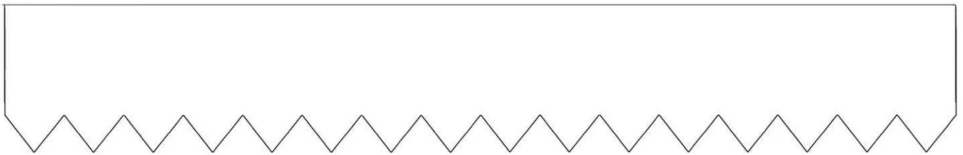

NEED HELP? CONTACT US!

Have product questions? Need technical support? Please feel free to contact us:

Technical Support and E-Warranty Certificate
www.vevor.com/support

This is the original instruction, please read all manual instructions carefully before operating. VEVOR reserves a clear interpretation of our user manual. The appearance of the product shall be subject to the product you received. Please forgive us that we won't inform you again if there are any technology or software updates on our product.

Sicherheitswarnung

- Lesen und verstehen Sie dieses gesamte Handbuch, bevor Sie dieses Produkt zusammenbauen, installieren, bedienen oder warten. Die Nichtbeachtung dieser Warnungen und Anweisungen kann zum Tod, zu Verletzungen oder zur Beschädigung wertvoller Gegenstände führen.
- Tragen Sie bei der Montage und Installation dieses Produkts eine ANSI-zugelassene Schutzbrille, strapazierfähige Arbeitshandschuhe und Sicherheitsschuhe. Halten Sie Unbeteiligte während der Montage vom Bereich fern
- Nicht aufbauen, wenn Sie müde sind oder unter dem Einfluss von Alkohol, Drogen oder Medikamenten stehen.
- Nur bestimmungsgemäß verwenden. **UM SCHWERE VERLETZUNGEN UND TOD DURCH UMKIPPEN ZU VERMEIDEN: SITZEN, STEHEN ODER KLETTERN SIE NICHT AUF DIESEM ARTIKEL.**
- **Dieses Produkt ist kein Spielzeug. Erlauben Sie Kindern nicht, mit oder in der Nähe dieses Artikels zu spielen.**
- Überprüfen Sie vor der Verwendung den allgemeinen Zustand des Produkts. Prüfen Sie auf: gebrochene, rissige oder verbogene Teile, lose oder fehlende Teile und jeden Zustand, der die ordnungsgemäße Funktion des Produkts beeinträchtigen könnte.

- Stellen Sie sicher, dass für den Austausch und die Reparatur nur Originalteile verwendet werden.

ANLEITUNG AUFBEWAHREN

SPEZIFIKATIONEN

Modell	JC40*6in 3St
Größe der einzelnen Metallkante	40 * 6 Zoll
Farbe	Schwarz

Modell	JC40* 8 Zoll 3 Stück
Größe der einzelnen Metallkante	40 * 8 Zoll
Farbe	Schwarz

Modell	JC40*6in 4 Stk
Größe der einzelnen Metallkante	40 * 6 Zoll
Farbe	Schwarz



Modell	JC40* 8 in 4 Stk
Größe der einzelnen Metallkante	40 * 6 Zoll
Farbe	Schwarz

Modell	JC40*6in 6 Stk
Größe der einzelnen Metallkante	40 * 6 Zoll
Farbe	Schwarz

Modell	JC40* 8 in 6 Stk
Größe der einzelnen Metallkante	40 * 8 Zoll
Farbe	Schwarz

Modell	JC12*40in 4St
Größe der einzelnen Metallkante	40 * 12 Zoll
Farbe	Schwarz

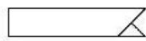
KOMPONENTEN

Modell			
	Metallkante	Verbinder	Handschuhe
JC40*6 in 3 Stück	x 3	x 5	X 1
JC40*8in 3St	x3	x5	
JC40* 6 Zoll 4 Stück	x4	x6	
JC40*8in 4 Stück	x 4	x 6	
JC40*6in 6 Stk	x 6	x 8	
JC40*8in 6 Stk	x 6	x 8	

JC12*40in 4 Stück	x 4	x 6	
----------------------	-----	-----	--

Notwendige Werkzeuge

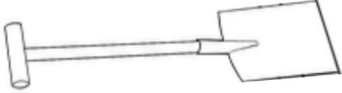
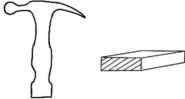
1. Spaten	
2. Hammer und ein Holzblock	

Montageanleitung

SCHRITT 1 Bereiten Sie eine Linie vor, der die Kante folgen soll, und entfernen Sie alle Hindernisse. Wenn der Boden steinig ist, lockern Sie ihn mit einer Spitzhacke.

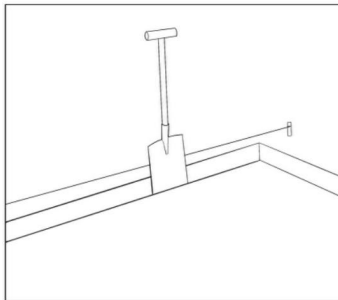

SCHRITT 2 Biegeanweisungen : Zum Biegen der Metallkante auf den erforderlichen Winkel wird eine Werkbank, eine Tischkante, ein Holz oder eine andere Unterlage empfohlen.

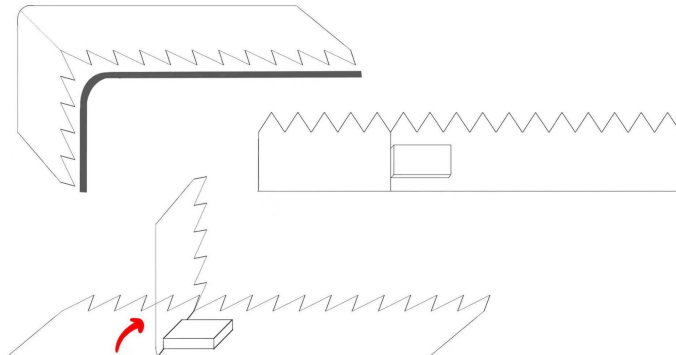

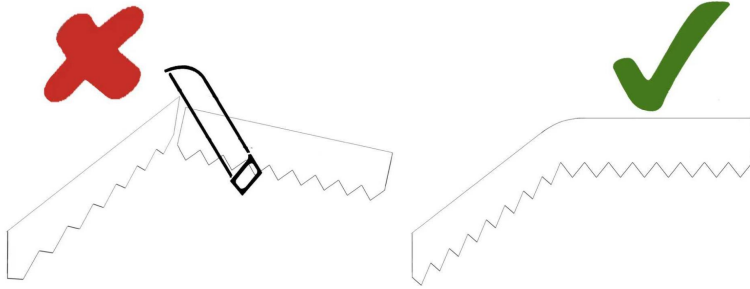

HINWEIS: Schneiden Sie nicht mit Gegenständen, da dies zu Verletzungen führen kann .

SCHRITT:3 Stecken Sie die verbundenen Metallkanten in den Boden und befestigen Sie sie mit einem Hammer.

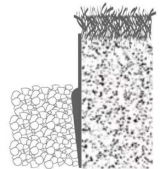
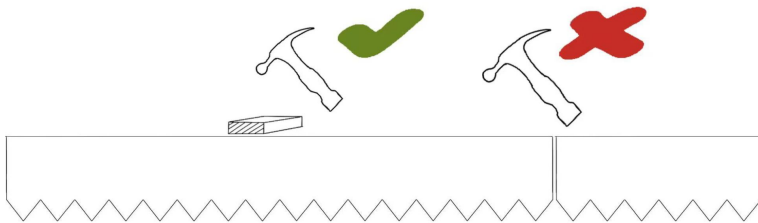

HINWEIS: Legen Sie beim Schlagen mit einem Hammer ein Stück Holz über die Metallkante, um eine Beschädigung der Metallkante zu vermeiden.

SCHRITT:4 Stecken Sie einen Stecker ein, um die Verbindung zu fixieren.

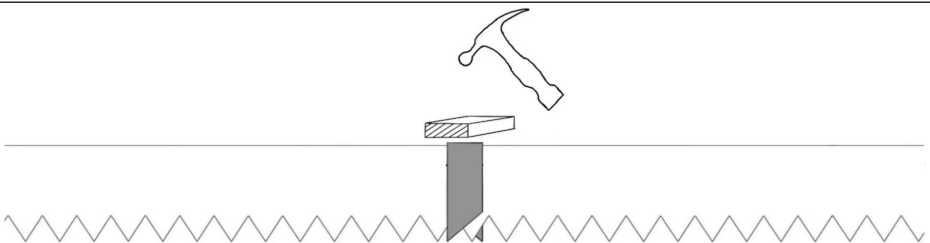

Ergänzende Erklärung : Die Metallbarriere kann je nach Bedarf in die gewünschte Form gebogen werden (einschließlich, aber nicht beschränkt auf die folgenden Formen).

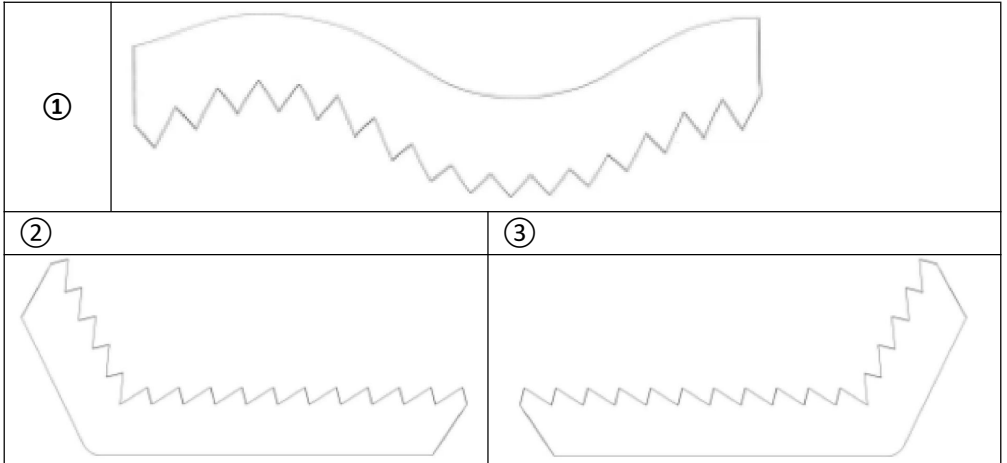

Adresse: Baoshanqu Shuangchenglu 803long 11hao 1602A-1609shi Shanghai

Importiert nach AUS: SIHAO PTY LTD, 1 ROKEVA STREETEASTWOOD NSW 2122
Australien

In die USA importiert: Sanven Technology Ltd. Suite 250, 9166 Anaheim Place, Rancho
Cucamonga, CA 91730

EC	REP	SHUNSHUN GmbH Römeräcker 9 Z2021,76351 Linkenheim-Hochstetten, Germany
-----------	------------	--

UK	REP	Pooledas Group Ltd Unit 5 Albert Edward House, The Pavilions Preston, United Kingdom
-----------	------------	--

In China hergestellt

VEVOR[®]

TOUGH TOOLS, HALF PRICE

Technisch Support- und E-Garantiezertifikat

www.vevor.com/support

VEVOR[®]

TOUGH TOOLS, HALF PRICE

Technique Assistance et certificat de garantie électronique
www.vevor.com/support

BORDURE EN MÉTAL MANUEL DE L'UTILISATEUR

We continue to be committed to provide you tools with competitive price.

"Save Half", "Half Price" or any other similar expressions used by us only represents an estimate of savings you might benefit from buying certain tools with us compared to the major top brands and does not necessarily mean to cover all categories of tools offered by us. You are kindly reminded to verify carefully when you are placing an order with us if you are actually saving half in comparison with the top major brands.

VEVOR[®]

TOUGH TOOLS, HALF PRICE

METAL EDGING

Modèle : JC40 * 6 pouces 3 pièces , JC40 * 8 pouces 3 pièces , JC40 * 6 pouces 4 pièces , JC40 * 8 pouces 4 pièces , JC40 * 6 pouces 6 pièces , JC40 * 8 pouces 6 pièces , JC12 * 40 pouces 4 pièces .



NEED HELP? CONTACT US!

Have product questions? Need technical support? Please feel free to contact us:

Technical Support and E-Warranty Certificate
www.vevor.com/support

This is the original instruction, please read all manual instructions carefully before operating. VEVOR reserves a clear interpretation of our user manual. The appearance of the product shall be subject to the product you received. Please forgive us that we won't inform you again if there are any technology or software updates on our product.



Alerte de sécurité

- Lisez et comprenez l'intégralité de ce manuel avant d'assembler, d'installer, d'utiliser ou d'entretenir ce produit. Le non-respect de ces avertissements et instructions peut entraîner la mort, des blessures ou des dommages à des biens de valeur.
- Portez des lunettes de sécurité approuvées par l'ANSI, des gants de travail robustes et des chaussures de sécurité pendant l'assemblage et l'installation de ce produit. Gardez les spectateurs hors de la zone pendant l'assemblage
- Ne vous rassemblez pas lorsque vous êtes fatigué ou sous l'influence de l'alcool, de drogues ou de médicaments.
- Utiliser uniquement comme prévu. **POUR ÉVITER DES BLESSURES GRAVES ET LA MORT PAR BASCULEMENT : NE PAS VOUS ASSOYER, NE VOUS TENIR OU GRIMER SUR CET ARTICLE.**
- **Ce produit n'est pas un jouet. Ne laissez pas les enfants jouer avec ou à proximité de cet article.**
- Avant utilisation, inspectez l'état général du produit. Vérifiez : les pièces cassées, fissurées ou pliées, les pièces desserrées ou manquantes et toute condition pouvant affecter le bon fonctionnement du produit.
- Assurez-vous que seules des pièces d'origine sont utilisées pour le remplacement et la réparation.

CONSERVEZ CES INSTRUCTIONS

CARACTÉRISTIQUES

Modèle	JC40 * 6 pouces 3 pièces
Taille du bord métallique unique	40*6 pouces
Couleur	Noir

Modèle	JC40* 8 en 3 pièces
Taille du bord métallique unique	40*8 pouces
Couleur	Noir

Modèle	JC40 * 6 pouces 4 pièces
Taille du bord métallique unique	40*6 pouces
Couleur	Noir

Modèle	JC40* 8 en 4 pièces
Taille du bord métallique unique	40*6 pouces
Couleur	Noir



Modèle	JC40 * 6 pouces 6 pièces
--------	--------------------------

Taille du bord métallique unique	40*6 pouces
Couleur	Noir

Modèle	JC40* 8 en 6 pièces
Taille du bord métallique unique	40*8 pouces
Couleur	Noir

Modèle	JC12 * 40 pouces 4 pièces
Taille du bord métallique unique	40*12 pouces
Couleur	Noir

COMPOSANTS

Modèle			
	Bordure en métal	Connecteur	Gants
JC40*6 en 3 pièces	x3 _	x5 _	X1 _
JC40 * 8 pouces 3 pièces	x3	x5	
JC40* 6 en 4 pièces	x4	x6	
JC40*8 pouces 4 pièces	x4 _	x6 _	
JC40*6 pouces	x6 _	x8 _	

6 pièces			
JC40*8 pouces 6 pièces	x6 _	x8 _	
JC12 * 40 pouces 4 pièces	x4 _	x6 _	

Outils requis

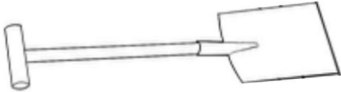
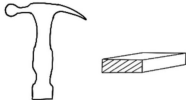
1. Bêche	
2. Un marteau et un bloc de bois	

Instructions d'assemblage

ÉTAPE 1 Préparez une ligne que la bordure devra suivre et éliminez toute obstruction. Si le sol est pierreux, desserrez avec une pioche.

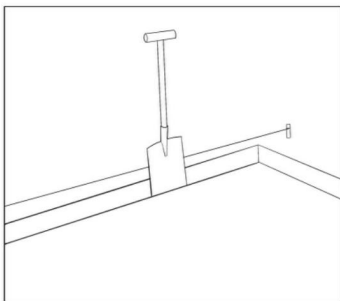

ÉTAPE 2 Instructions de pliage : Un établi de travail, le bord d'une table, un bois ou autre forme est conseillé pour plier le bord métallique à l'angle requis.

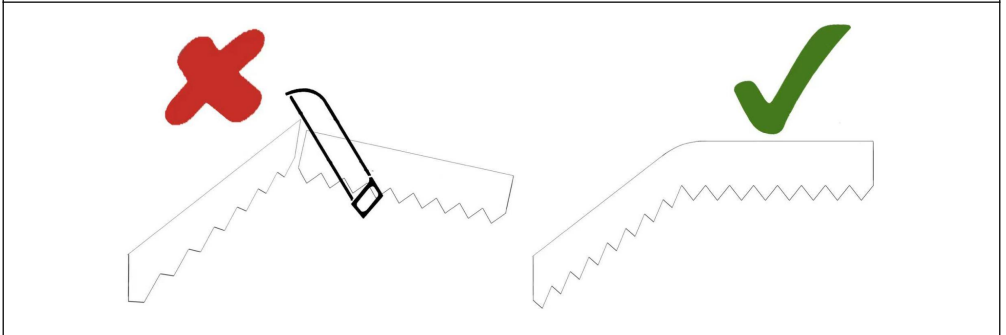
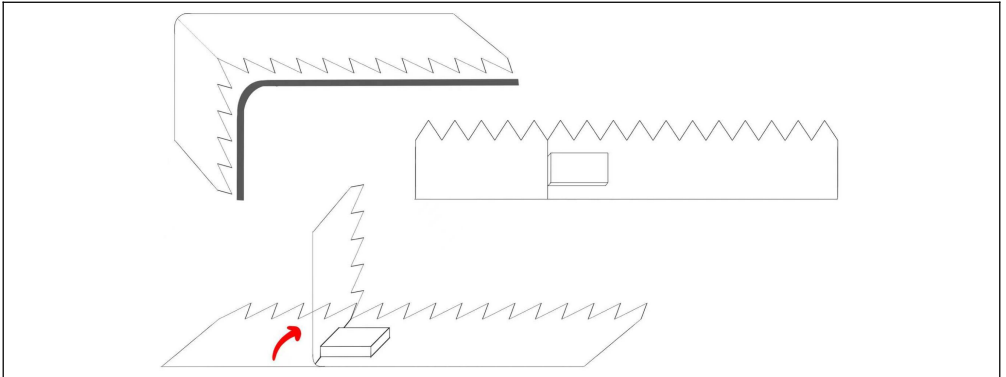

REMARQUE : Ne coupez rien car cela pourrait provoquer des blessures .

ÉTAPE : 3 Insérez les bords métalliques connectés dans le sol et fixez-les avec un marteau.

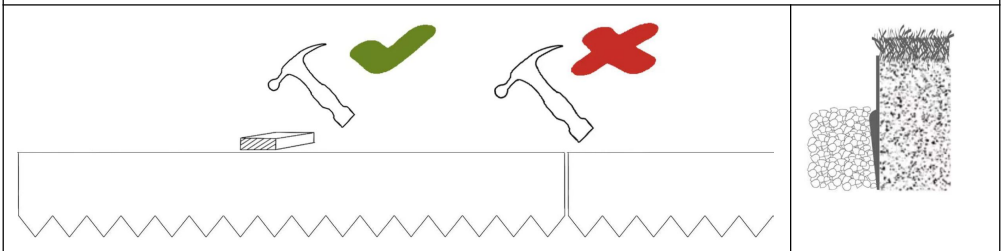

REMARQUE : Placez un morceau de bois sur le bord métallique lorsque vous frappez avec un marteau pour éviter d'endommager le bord métallique.

ÉTAPE : 4 Insérez un connecteur pour fixer la connexion.

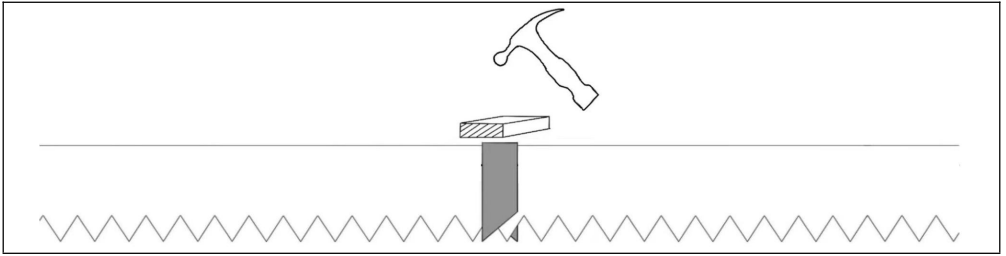

Déclaration complémentaire : La barrière métallique peut être pliée dans la forme dont vous avez besoin en fonction de vos besoins (y compris, mais sans s'y limiter, les formes suivantes).

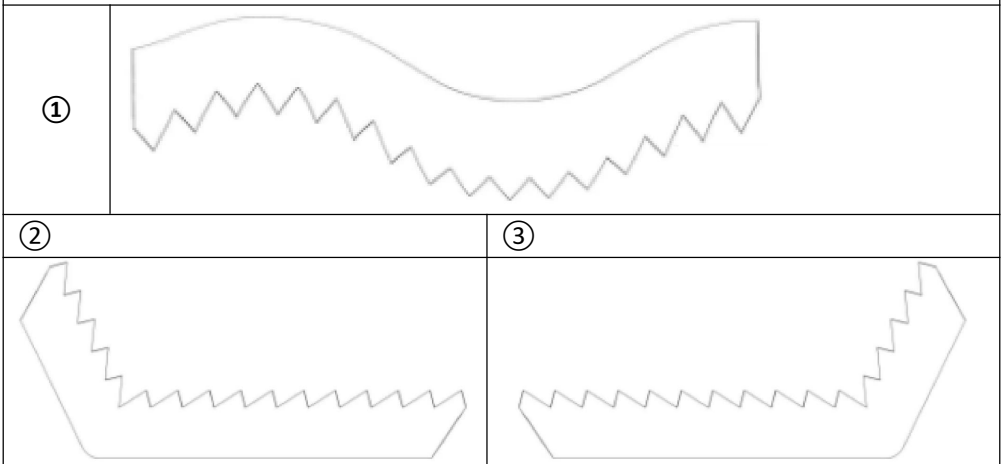

Adresse : Baoshanqu Shuangchenglu 803long 11hao 1602A-1609shi Shanghai

Importé en Australie : SIHAO PTY LTD, 1 ROKEVA STREETASTWOOD NSW 2122
Australie

Importé aux États-Unis : Sanven Technology Ltd.Suite 250, 9166 Anaheim Place, Rancho
Cucamonga, CA 91730

EC	REP	SHUNSHUN GmbH Römeräcker 9 Z2021,76351 Linkenheim-Hochstetten, Germany
-----------	------------	--

UK	REP	Pooledas Group Ltd Unit 5 Albert Edward House, The Pavilions Preston, United Kingdom
-----------	------------	--

Fabriqué en Chine

VEVOR[®]

TOUGH TOOLS, HALF PRICE

Technique Assistance et certificat de garantie électronique

www.vevor.com/support

VEVOR[®]

TOUGH TOOLS, HALF PRICE

Technisch Ondersteuning en e-garantiecertificaat www.vevor.com/support

METALEN RANDEN HANDLEIDING

We continue to be committed to provide you tools with competitive price.

"Save Half", "Half Price" or any other similar expressions used by us only represents an estimate of savings you might benefit from buying certain tools with us compared to the major top brands and does not necessarily mean to cover all categories of tools offered by us. You are kindly reminded to verify carefully when you are placing an order with us if you are actually saving half in comparison with the top major brands.

VEVOR®

TOUGH TOOLS, HALF PRICE

METAL EDGING

Model: JC40*6in 3 stuks , JC40* 8 in 3 stuks , JC40*6in 4 stuks , JC40* 8 in 4 stuks , JC40*6in 6 stuks , JC40* 8 in 6 stuks , JC12*40in 4 stuks

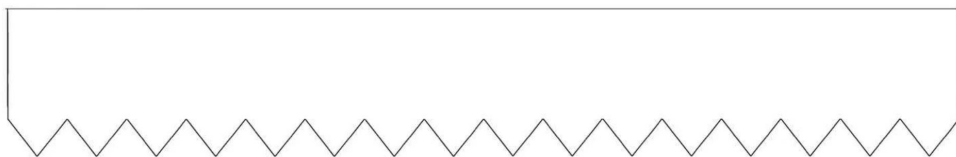

NEED HELP? CONTACT US!

Have product questions? Need technical support? Please feel free to contact us:

Technical Support and E-Warranty Certificate
www.vevor.com/support

This is the original instruction, please read all manual instructions carefully before operating. VEVOR reserves a clear interpretation of our user manual. The appearance of the product shall be subject to the product you received. Please forgive us that we won't inform you again if there are any technology or software updates on our product.

Veiligheidswaarschuwing

- Lees en begrijp deze gehele handleiding voordat u dit product monteert, installeert, bedient of onderhoudt. Het niet opvolgen van deze waarschuwingen en instructies kan de dood, persoonlijk letsel of schade aan waardevolle eigendommen veroorzaken.
- Draag een ANSI-goedgekeurde veiligheidsbril, stevige werkhandschoenen en veiligheidsschoenen tijdens de montage en installatie van dit product. Houd omstanders tijdens de montage uit de buurt
- Niet monteren als u moe bent of onder invloed bent van alcohol, drugs of medicijnen.
- Alleen gebruiken zoals bedoeld. **OM ERNSTIG LETSEL EN DE DOOD DOOR KANTELEN TE VOORKOMEN: ZIT, STA OF KLIM NIET OP DIT ITEM.**
- **Dit product is geen speelgoed. Laat kinderen niet met of in de buurt van dit artikel spelen.**
- Inspecteer vóór gebruik de algemene staat van het product. Controleer op: gebroken, gebarsten of verbogen onderdelen, losse of ontbrekende onderdelen en alle omstandigheden die de goede werking van het product kunnen beïnvloeden.
- Zorg ervoor dat alleen originele onderdelen worden gebruikt voor vervanging en reparatie.

BEWAAR DEZE INSTRUCTIES

SPECIFICATIES

Model	JC40*6in 3 stuks
Grootte van enkele metalen rand	40 * 6 inch
Kleur	Zwart

Model	JC40* 8 in 3 stuks
Grootte van enkele metalen rand	40 * 8 inch
Kleur	Zwart

Model	JC40*6in 4 stuks
Grootte van enkele metalen rand	40 * 6 inch
Kleur	Zwart

Model	JC40* 8 in 4 stuks
Grootte van enkele metalen rand	40 * 6 inch
Kleur	Zwart



Model	JC40*6in 6 stuks
Grootte van enkele metalen rand	40 * 6 inch
Kleur	Zwart

Model	JC40* 8 in 6 stuks
Grootte van enkele metalen	40 * 8 inch

rand	
Kleur	Zwart

Model	JC12*40in 4 stuks
Grootte van enkele metalen rand	40 * 12 inch
Kleur	Zwart

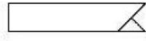
COMPONENTEN

Model			
	Metalen rand	Connector	Handschoenen
JC40*6 in 3 stuks	x 3	x 5	X 1
JC40*8in 3 stuks	x3	x5	
JC40* 6 in 4 stuks	x4	x6	
JC40*8in 4 stuks	x 4	x 6	
JC40*6in 6 stuks	x 6	x 8	
JC40*8in 6 stuks	x 6	x 8	
JC12*40in 4 stuks	x 4	x 6	

Benodigd gereedschap

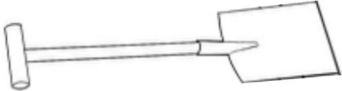
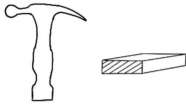
1. Schoppen	
2. Hamer en een blok hout	

Instructies samenstellen

STAP 1 Bereid een lijn voor die de rand kan volgen en verwijder eventuele obstakels. Als de grond steenachtig is, maak deze dan los met een houweel.

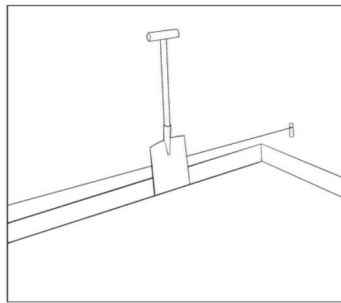

STAP 2 Buiginstructies : Een werkbank, de rand van een tafel, een stuk hout of iets anders wordt geadviseerd bij het buigen van de metalen rand in de gewenste hoek.

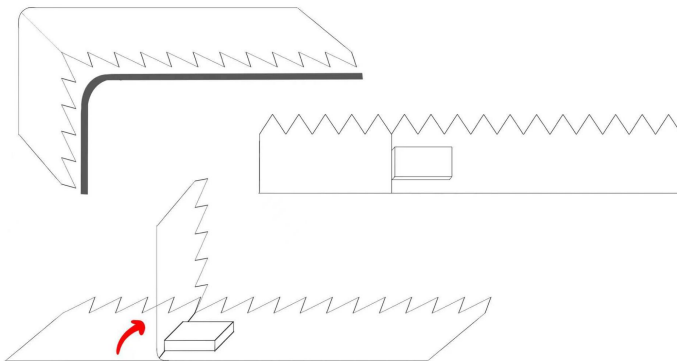

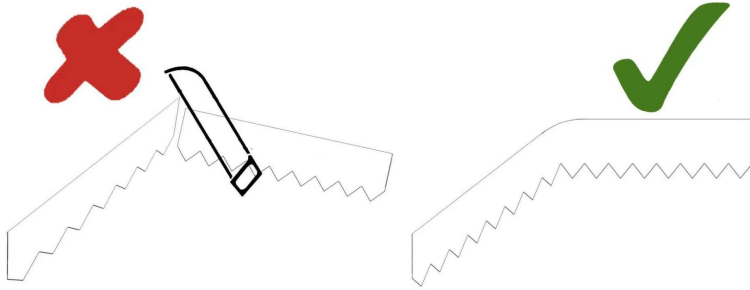

OPMERKING: Snijd nergens mee, omdat dit letsel kan veroorzaken .

STAP:3 Steek de aangesloten metalen randen in de grond en zet deze vast met een hamer.

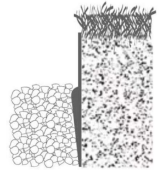
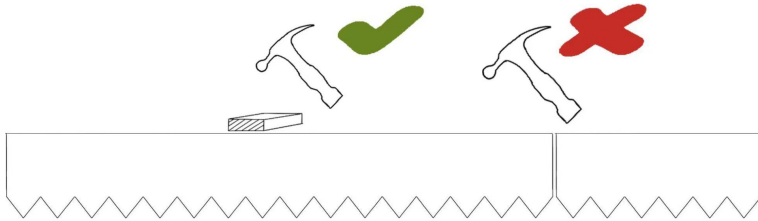

OPMERKING: Plaats een stuk hout over de metalen rand wanneer u met een hamer slaat om beschadiging van de metalen rand te voorkomen.

STAP:4 Plaats een connector om de verbinding te bevestigen.

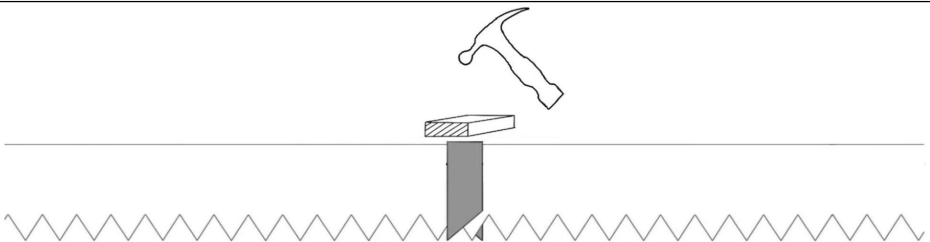

Aanvullende verklaring : De metalen barrière kan in de gewenste vorm worden gebogen, afhankelijk van uw behoeften (inclusief maar niet beperkt tot de volgende vormen).

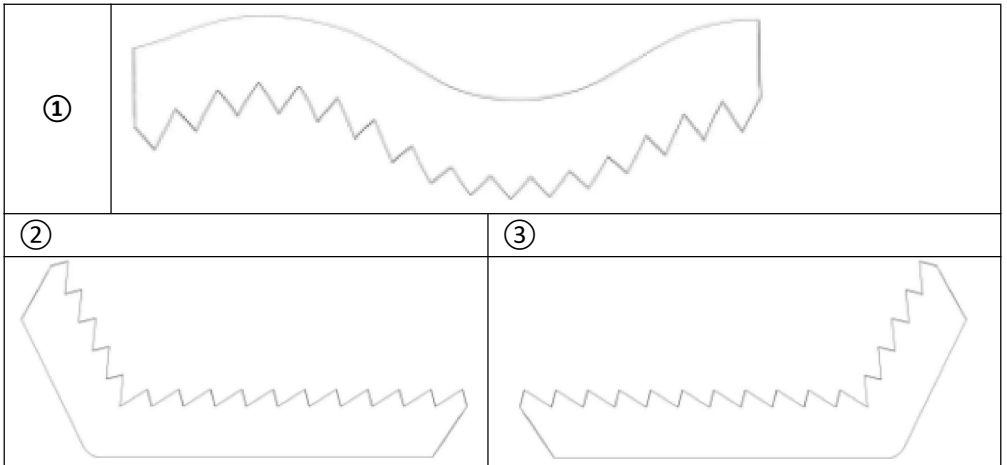

Adres: Baoshanqu Shuangchenglu 803long 11hao 1602A-1609shi Shanghai

Geïmporteerd naar AUS: SIHAO PTY LTD, 1 ROKEVA STREETEASTWOOD NSW 2122
Australië

Geïmporteerd naar de VS: Sanven Technology Ltd.Suite 250, 9166 Anaheim Place,
Rancho Cucamonga, CA 91730

EC	REP	SHUNSHUN GmbH Römeräcker 9 Z2021,76351 Linkenheim-Hochstetten, Germany
-----------	------------	--

UK	REP	Pooledas Group Ltd Unit 5 Albert Edward House, The Pavilions Preston, United Kingdom
-----------	------------	--

Gemaakt in China

VEVOR[®]

TOUGH TOOLS, HALF PRICE

Technisch Ondersteuning en e-garantiecertificaat

www.vevor.com/support

VEVOR[®]

TOUGH TOOLS, HALF PRICE

Teknisk Support och e-garanticertifikat www.vevor.com/support

METALLKANT ANVÄNDARMANUAL

We continue to be committed to provide you tools with competitive price.

"Save Half", "Half Price" or any other similar expressions used by us only represents an estimate of savings you might benefit from buying certain tools with us compared to the major top brands and does not necessarily mean to cover all categories of tools offered by us. You are kindly reminded to verify carefully when you are placing an order with us if you are actually saving half in comparison with the top major brands.

VEVOR®

TOUGH TOOLS, HALF PRICE

METAL EDGING

Modell: JC40 *6in 3st , JC40* 8 i 3st , JC40 * 6in 4st , JC40* 8 i 4st , JC40*6in 6st , JC40* 8 i 6st , JC12* 40in 4st

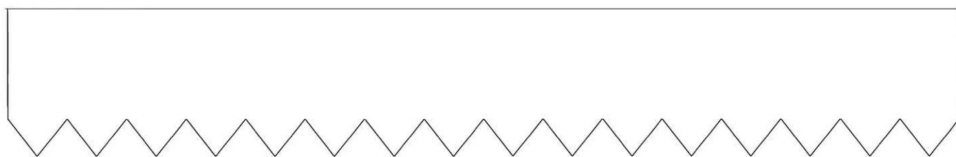

NEED HELP? CONTACT US!

Have product questions? Need technical support? Please feel free to contact us:

Technical Support and E-Warranty Certificate
www.vevor.com/support

This is the original instruction, please read all manual instructions carefully before operating. VEVOR reserves a clear interpretation of our user manual. The appearance of the product shall be subject to the product you received. Please forgive us that we won't inform you again if there are any technology or software updates on our product.

Sårhet och varning

- Läs och förstå hela denna manual innan du monterar, installerar, använder eller servar denna produkt. Underlåtenhet att följa dessa varningar och instruktioner kan orsaka dödsfall, personskada eller skada på värdefull egendom.
- Bär ANSI-godkända skyddsglasögon, kraftiga arbetshandskar och skyddsskor under montering och installation av denna produkt. Håll åskådare borta från området under monteringen
- Sätt dig inte ihop när du är trött eller påverkad av alkohol, droger eller mediciner.
- Använd endast som avsett. **FÖR ATT FÖRHINDRA ALLVARLIGA SKADA OCH DÖDSFALL OM ATT VÄLTA: SIT, STÅ ELLER KLÄTTRA INTE PÅ DETTA FÖREMÅL.**
- **Denna produkt är inte en leksak. Låt inte barn leka med eller nära detta föremål.**
- Inspektera produktens allmänna skick före användning. Kontrollera efter: trasiga, spruckna eller böjda delar, lösa eller saknade delar och alla tillstånd som kan påverka produktens korrekta funktion.
- Se till att endast äkta delar används för utbyte och reparation.

SPARA DESSA INSTRUKTIONER

SPECIFIKATIONER

Modell	JC40*6in 3st
Storlek på Enkel metallkant	40*6 tum
Färg	Svart

Modell	JC40* 8 i 3 st
Storlek på Enkel metallkant	40*8 tum
Färg	Svart

Modell	JC40*6in 4 st
Storlek på Enkel metallkant	40*6 tum
Färg	Svart



Modell	JC40* 8 i 4 st
Storlek på Enkel metallkant	40*6 tum
Färg	Svart

Modell	JC40*6in 6 st
Storlek på Enkel metallkant	40*6 tum
Färg	Svart

Modell	JC40* 8 i 6 st
Storlek på Enkel metallkant	40*8 tum
Färg	Svart

Modell	JC12*40in 4st
Storlek på Enkel metallkant	40*12 tum
Färg	Svart

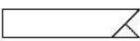
KOMPONENTER

Modell			
	Metallkant	Anslutning	Handskar
JC40*6 i 3 st	x 3	x 5	X 1
JC40*8in 3st	x3	x5	
JC40* 6 i 4 st	x4	x6	
JC40*8 tum 4 st	x 4	x 6	
JC40*6tum 6 st	x 6	x 8	
JC40*8 tum 6 st	x 6	x 8	
JC12*40tum 4 st	x 4	x 6	

Nödvändiga verktyg

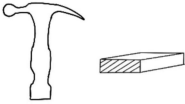
1. Spader	
2. Hammare och ett träblock	

Monteringsanvisningar

STEG 1 Förbered en linje som kanterna ska följa och ta bort eventuella hinder. Om marken är stenig, lossa med hacka.

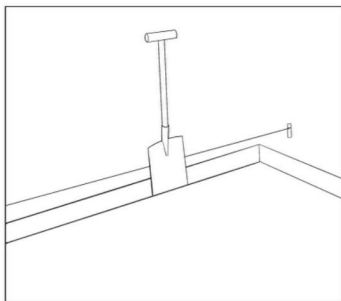

STEG 2 Böjningsinstruktioner : En arbetsbänk, kanten på ett bord, en timmer eller annan form rekommenderas när du böjer metallkanten till önskad vinkel.

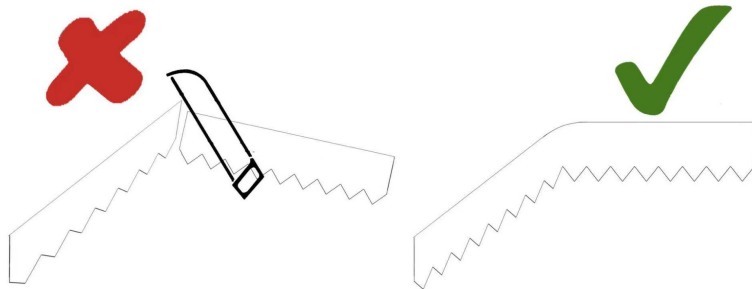
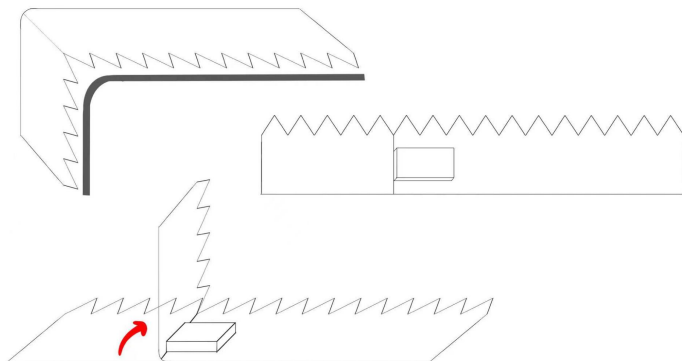

OBS: Skär inte med något eftersom det kan orsaka skada .

STEG:3 Sätt in de anslutna metallkanterna i marken och fäst den med en hammare.

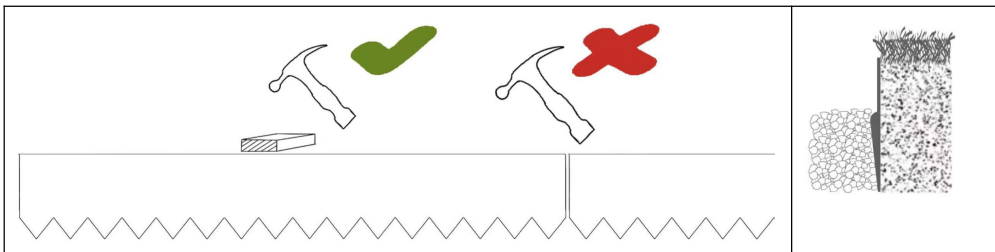

OBS: Placera en träbit över metallkanten när du slår med en hammare för att undvika att skada metallkanten.

STEG:4 Sätt i en kontakt för att fixa anslutningen.

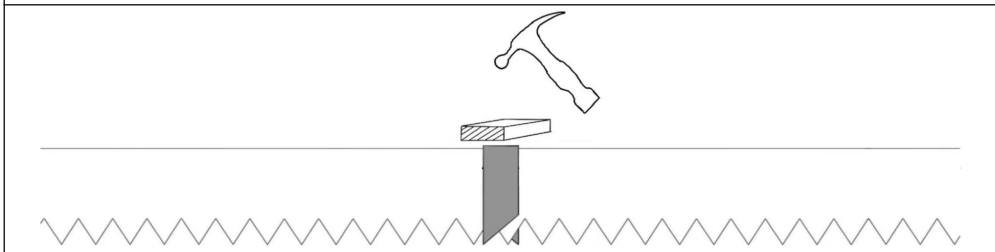

Kompletterande uttalande : Metallbarriären kan böjas till den form du behöver enligt dina behov (inklusive men inte begränsat till följande former).

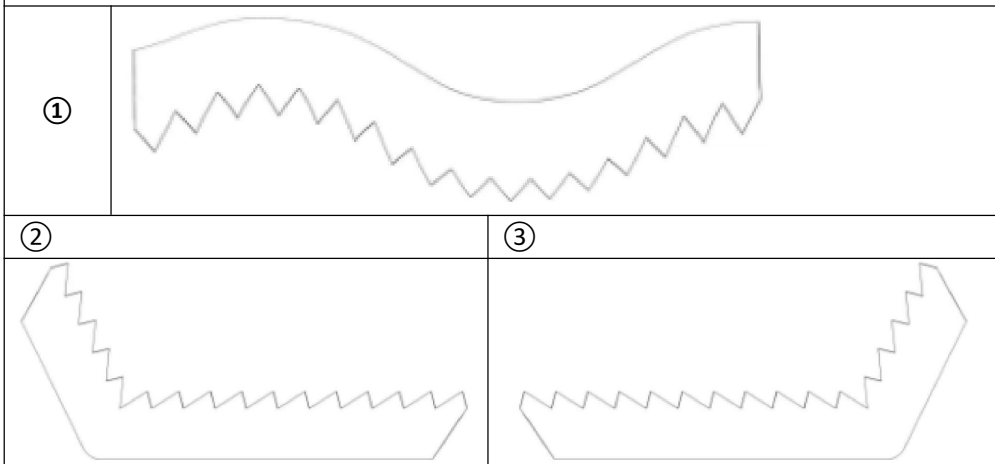

Adress: Baoshanqu Shuangchenglu 803long 11hao 1602A-1609shi Shanghai

Importerad till AUS: SIHAO PTY LTD, 1 ROKEVA STREETEASTWOOD NSW 2122

Australien

Importerad till USA: Sanven Technology Ltd.Suite 250, 9166 Anaheim Place, Rancho

Cucamonga, CA 91730



SHUNSHUN GmbH
Römeräcker 9 Z2021,76351
Linkenheim-Hochstetten, Germany



Pooledas Group Ltd
Unit 5 Albert Edward House, The
Pavilions Preston, United Kingdom

Tillverkad i Kina

VEVOR[®]

TOUGH TOOLS, HALF PRICE

Teknisk Support och e-garanticertifikat

www.vevor.com/support