

VEVOR

Affordable. Reliable. Home Improvement.

BOOK CARTS

MODEL: HXTC-3VD

VEVOR

Affordable. Reliable. Home Improvement.

BOOK CARTS

MODEL: HXTC-3VD

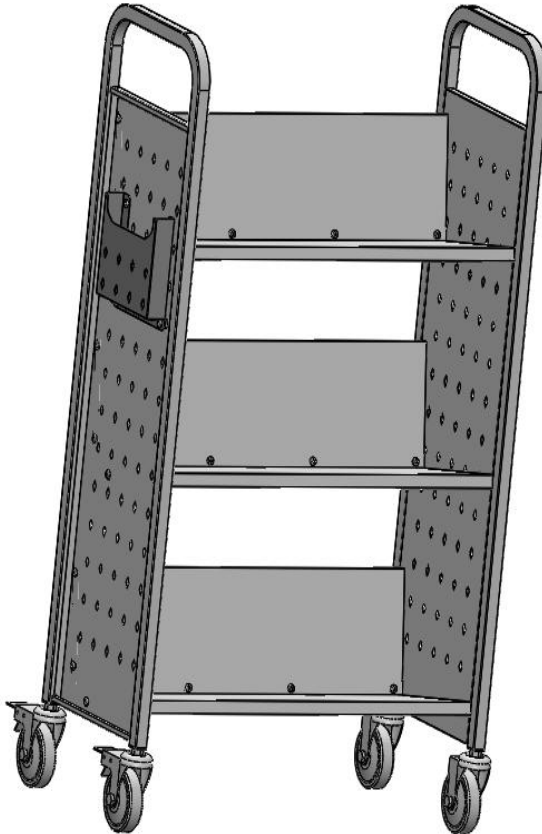

This is the original instruction, please read all manual instructions carefully before operating. VEVOR reserves a clear interpretation of our user manual. The appearance of the product shall be subject to the product you received. Please forgive us that we won't inform you again if there are any technology or software updates on our product.

SAFETY INSTRUCTIONS

1. It is forbidden to carry people under any condition.
2. Keep the product on level surfaces. It is forbidden to load articles on uneven and hilly terrains. The product may become unstable and tip if stored or moved on an unlevel surface, which may cause personal injury or product damage.
3. Overload is strictly prohibited.
4. Don't move too fast when passing pothole areas.
5. Use the brakes when this product is not being moved. This prevents the product from rolling.
6. Do not alter this product in any manner.
7. Do not lift the product directly with a forklift or tow with any mechanical devices.

MODEL AND PARAMETERS





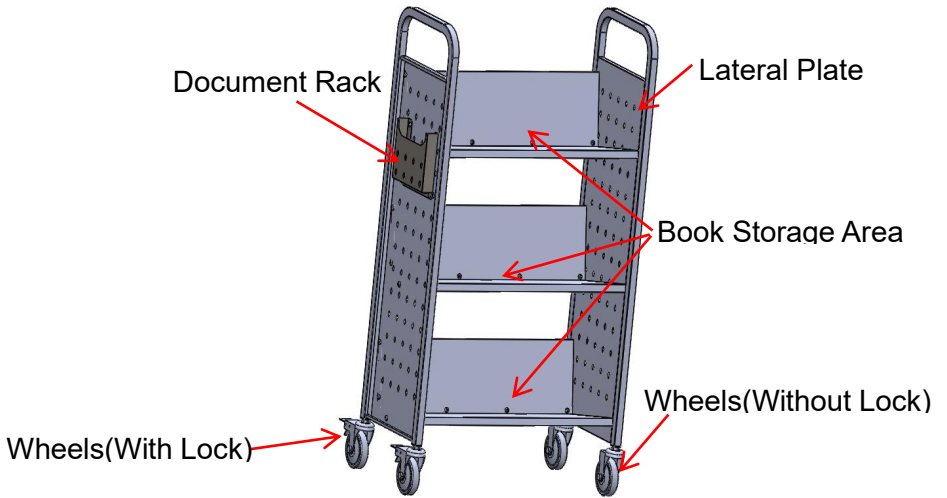

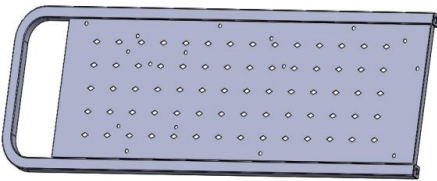
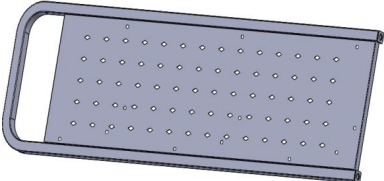
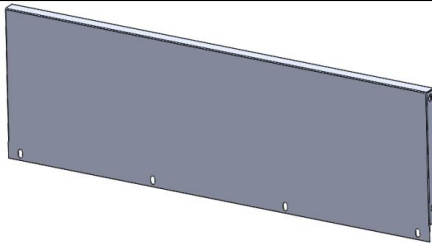
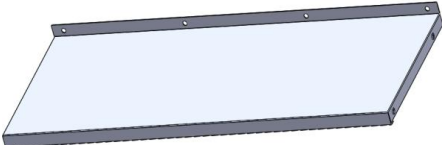

Model	HXTC-3VD
Shelve Type	V-shaped(Single-sided)
Number of Shelves	3
Max. Capacity	110lbs/per shelf
Material	Steel
Color	Black / White

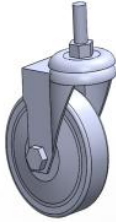
STRUCTURE DIAGRAM

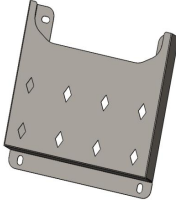

PARTS LIST

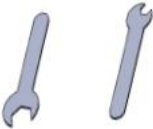
	
Lateral Plates x1	Lateral Plates x1
	
Bookshelf Backboards x3	Book Storage Panels x3

	
<p>Wheels(Without Lock) x2</p>	<p>Wheels(With Lock) x2</p>
	
<p>Bookends x1</p>	<p>Document Rack x1</p>
	
<p>Hex key x1</p>	<p>Hat nuts(M6) x16</p>
	
<p>Bolts(M6*8) x16</p>	<p>Wrenchs(10+19mm) x2</p>
	
<p>Bolts(M6*14) x24</p>	<p>User Manual x1</p>

INSTALLATION

NOTE: This installation is best done by two people.

Step 1: Install the Book Storage Panel.

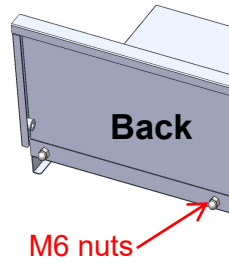
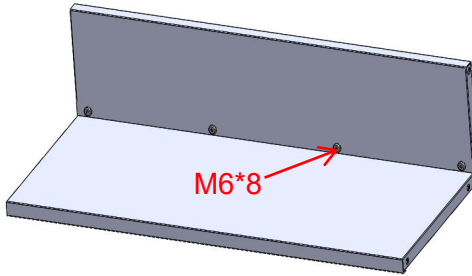

NOTE: Please do not tighten the bolts yet.

Step 2: Install the Lateral Plates.

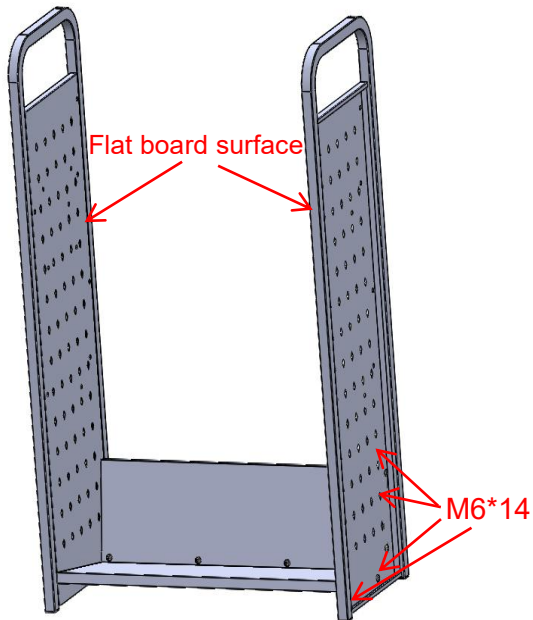

Step 3: After all parts are installed, adjust the angle of the frame and tighten all bolts.

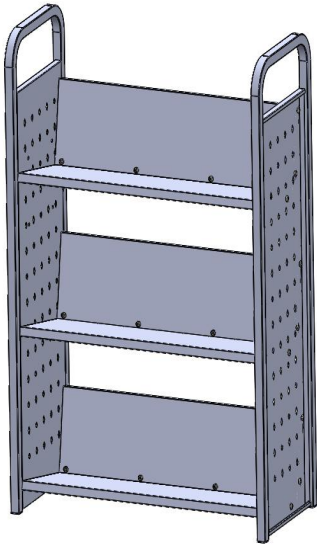

Step 4: Install the Document Rack.

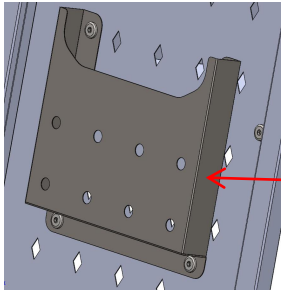

M6*8+Hat Nuts

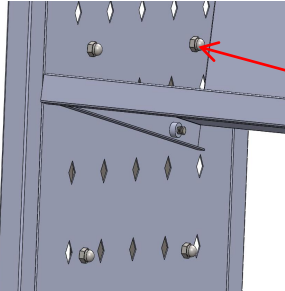

Hat Nuts

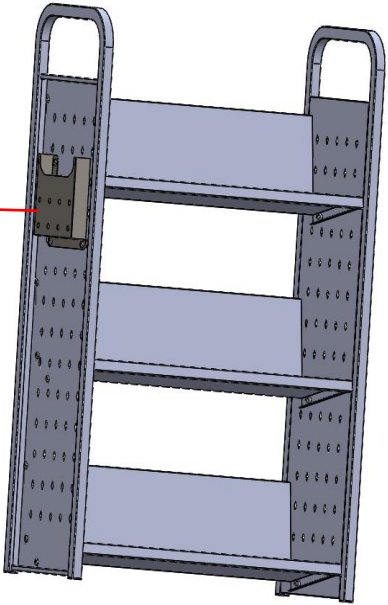

Step 5: Install the four wheels.

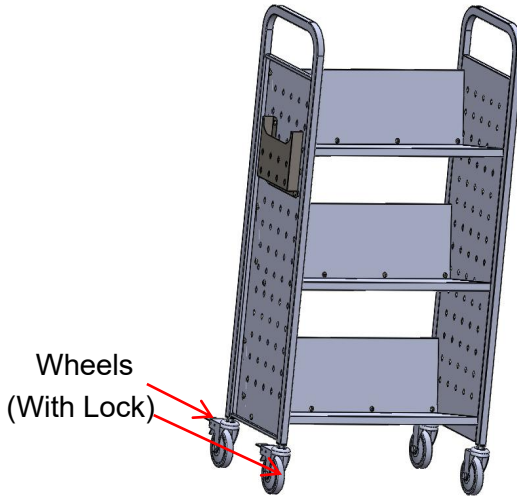

USING THE CASTER BRAKE

- To lock the swivel casters with brake, step down the levers.
- To unlock the swivel casters with brake, pull up the levers.

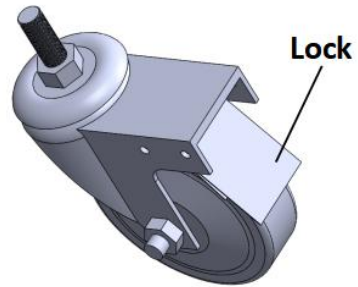
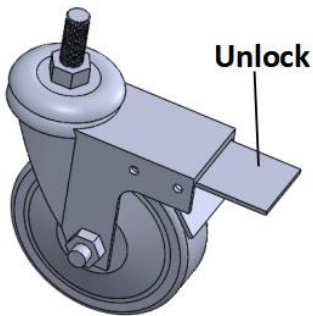

MAINTENANCE

1. Clean the surface after each use .
Please check and confirm that the cart is intact before each use.
2. Check that the bolts are tight.
3. Wheel bearings are regularly lubricated with grease.

Manufacturer: Shanghai muxinmuyeyouxiangongsi

Address: Shuangchenglu 803nong11hao1602A-1609shi, baoshanqu, shanghai 200000 CN.

Imported to AUS: SIHAO PTY LTD. 1 ROKEVA STREET EASTWOOD NSW 2122 Australia

Imported to USA: Sanven Technology Ltd. Suite 250, 9166 Anaheim Place, Rancho Cucamonga, CA 91730

UK	REP
-----------	------------

YH CONSULTING LIMITED. C/O YH Consulting Limited Office 147, Centurion House, London Road, Staines-upon-Thames, Surrey, TW18 4AX

EC	REP
-----------	------------

E-CrossStu GmbH
Mainzer Landstr.69,
60329 Frankfurt am Main.



VEVOR

Affordable. Reliable. Home Improvement.

CHARIOTS À LIVRES

MODÈLE : HXTC-3VD

VEVOR

Affordable. Reliable. Home Improvement.

CHARIOTS À LIVRES

MODÈLE : HXTC-3VD

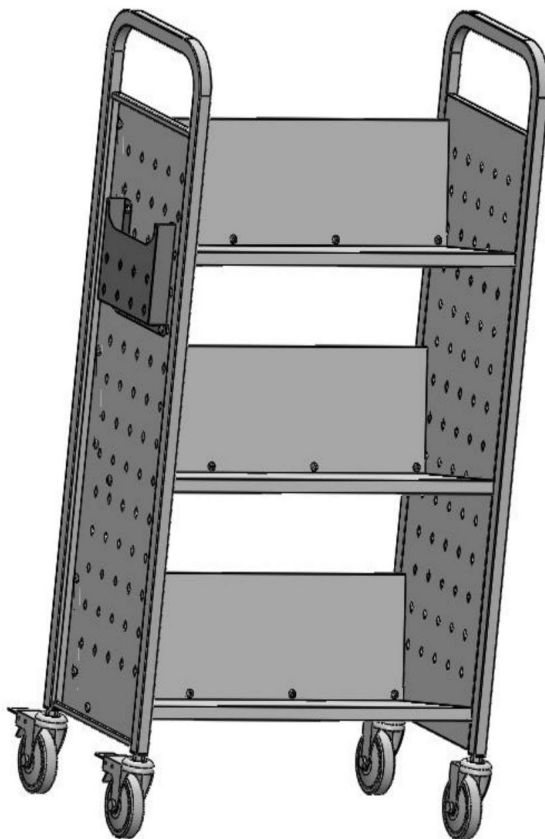

Ceci est le mode d'emploi d'origine. Veuillez lire attentivement l'intégralité du manuel avant utilisation. VEVOR se réserve le droit d'interpréter clairement ce manuel d'utilisation. L'apparence du produit dépend du produit que vous avez reçu. Veuillez nous excuser pour les éventuelles mises à jour technologiques ou logicielles.

CONSIGNES DE SÉCURITÉ

1. Il est interdit de transporter des personnes sous quelque condition que ce soit.
2. Conserver le produit sur des surfaces planes. Il est interdit de charger des articles sur terrains accidentés et vallonnés. Le produit peut devenir instable et basculer si stocké ou déplacé sur une surface instable, ce qui peut entraîner des blessures corporelles ou des dommages au produit.
3. La surcharge est strictement interdite.
4. Ne vous déplacez pas trop vite lorsque vous passez près des nids-de-poule.
5. Utilisez les freins lorsque ce produit n'est pas déplacé. Cela empêche le produit du laminage.
6. Ne modifiez en aucune façon ce produit.
7. Ne soulevez pas le produit directement avec un chariot élévateur ni ne le remorquez avec un dispositif mécanique. appareils.

MODÈLE ET PARAMÈTRES

Modèle	HXTC-3VD
Type d'étagère	En forme de V (unilatéral)
Nombre d'étagères	3
Capacité maximale	110 lb/par étagère
Matériel	Acier
Couleur	Noir / Blanc

SCHÉMA DE STRUCTURE

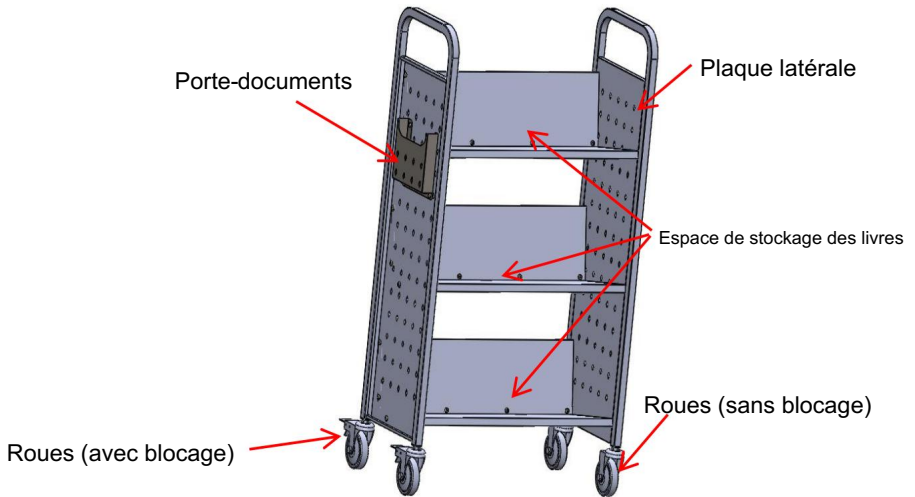

LISTE DES PIÈCES

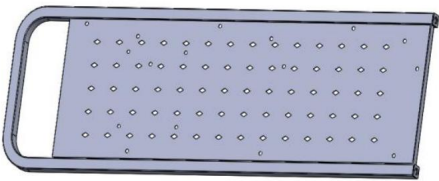
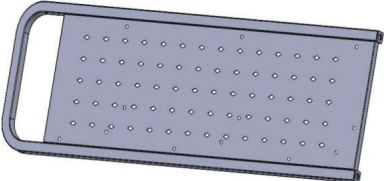
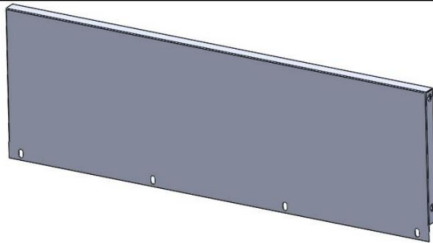
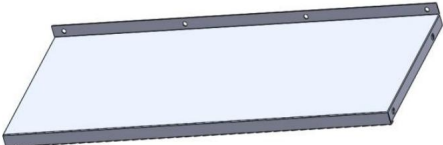
	
Plaques latérales x1	Plaques latérales x1
	
Panneaux arrière pour étagères x3	Panneaux de rangement pour livres x3

	
<p>Roues (sans blocage) x2</p>	<p>Roues (avec verrou) x2</p>
	
<p>Serre-livres x1</p>	<p>Porte-documents x1</p>
	
<p>Clé hexagonale x1</p>	<p>Écrous à chapeau (M6) x16</p>
	
<p>Boulons (M6*8) x16</p>	<p>Clés (10+19mm) x2</p>
	
<p>Boulons (M6*14) x24</p>	<p>Manuel d'utilisation x1</p>

INSTALLATION

REMARQUE : Il est préférable que cette installation soit effectuée par deux personnes.

Étape 1 : Installez le panneau de rangement des livres.

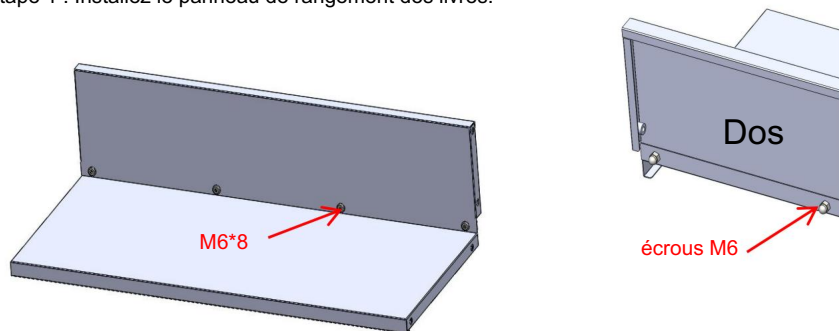

REMARQUE : Ne serrez pas encore les boulons.

Étape 2 : Installez les plaques latérales.

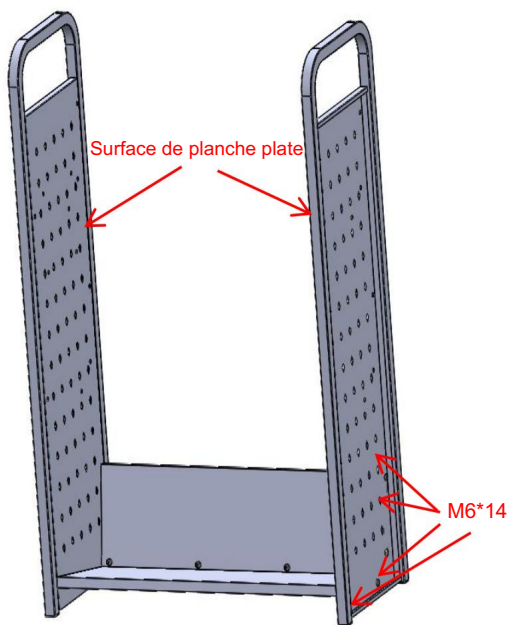

Étape 3 : Une fois toutes les pièces installées, ajustez l'angle du cadre et serrez tous les boulons.

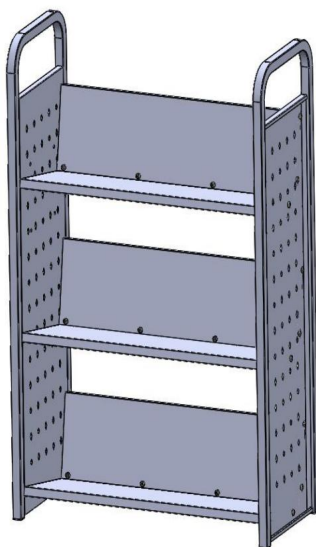

Étape 4 : Installez le porte-documents.

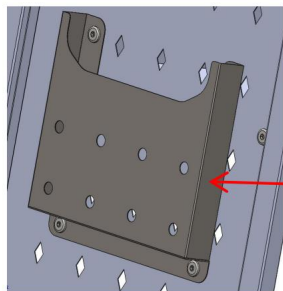

Écrous à chapeau M6*8+



Noix de chapeau

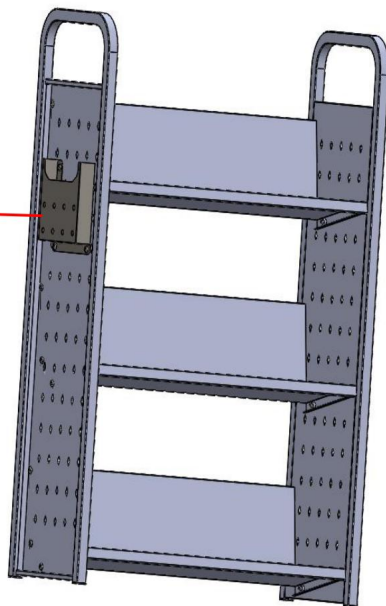

Étape 5 : Installez les quatre roues.

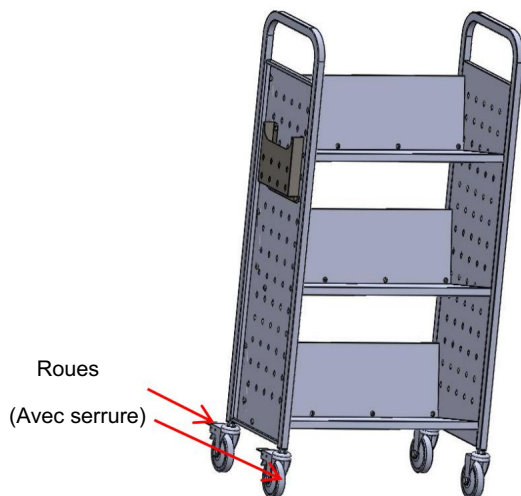

UTILISATION DU FREIN DE ROULETTE

■ Pour verrouiller les roulettes pivotantes avec frein, abaissez les leviers. ■ Pour déverrouiller les roulettes pivotantes avec frein, tirez les leviers vers le haut.

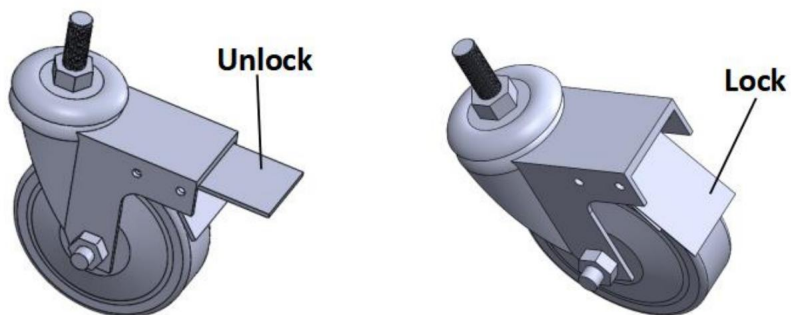

ENTRETIEN

1. Nettoyez la surface après chaque utilisation.

Veillez vérifier et confirmer que le chariot est intact avant chaque utilisation.

2. Vérifiez que les boulons sont bien serrés.

3. Les roulements de roue sont régulièrement lubrifiés avec de la graisse.

Fabricant : Shanghaimuxinmuyeyouxiangongsi Adresse :
Shuangchenglu 803nong11hao1602A-1609shi, baoshanqu, shanghai 200000 CN.

Importé en Australie : SIHAO PTY LTD. 1 ROKEVA STREET, ASTWOOD NSW 2122 Australie Importé
aux États-Unis : Sanven

Technology Ltd. Suite 250, 9166 Anaheim Place, Rancho Cucamonga, CA 91730

Représentant du Royaume-Uni	
-----------------------------	--

YH CONSULTING LIMITED. A/S YH Consulting Limited,
bureau 147, Centurion House, London Road, Staines-
upon-Thames, Surrey, TW18 4AX

REPRÉSENTANT DE LA CE	
-----------------------	--

E-CrossStu GmbH
Mainzer Landstr.69,
60329 Francfort-sur-le-Main.



VEVOR

Affordable. Reliable. Home Improvement.

Bücherwagen

MODELL: HXTC-3VD

VEVOR

Affordable. Reliable. Home Improvement.

Bücherwagen

MODELL: HXTC-3VD

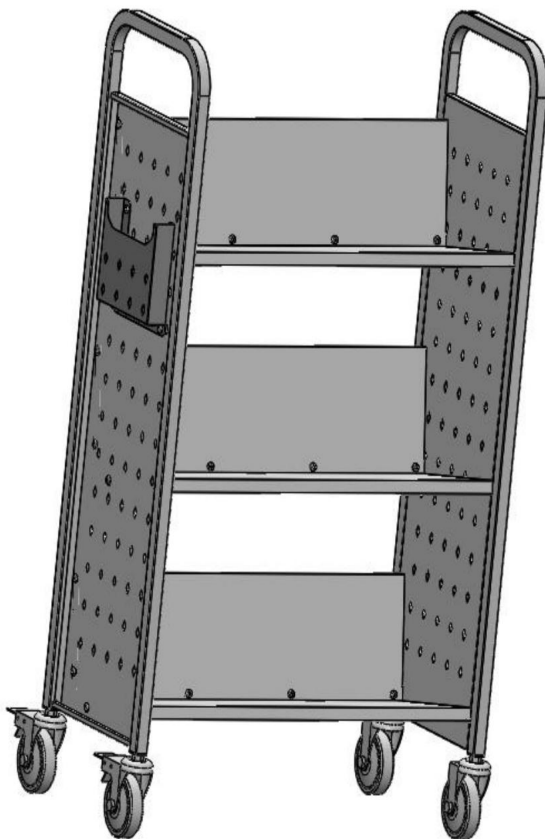

Dies ist die Originalanleitung. Bitte lesen Sie alle Anweisungen sorgfältig durch, bevor Sie das Gerät in Betrieb nehmen. VEVOR behält sich das Recht vor, die Bedienungsanleitung klar und deutlich zu interpretieren. Das Aussehen des Produkts hängt vom gelieferten Produkt ab. Bitte haben Sie Verständnis dafür, dass wir Sie nicht erneut über Technologie- oder Software-Updates informieren.

SICHERHEITSHINWEISE

1. Das Mitführen von Personen ist unter allen Umständen verboten.
2. Stellen Sie das Produkt auf ebene Flächen. Es ist verboten, Gegenstände auf unebenem und hügeligem Gelände. Das Produkt kann instabil werden und kippen, wenn auf einer unebenen Fläche gelagert oder bewegt werden, was zu Verletzungen führen kann oder Produktschäden.
3. Überlastung ist strengstens verboten.
4. Fahren Sie nicht zu schnell durch Schlaglöcher.
5. Benutzen Sie die Bremsen, wenn das Produkt nicht bewegt wird. Dies verhindert das Produkt am Wegrollen zu hindern.
6. Verändern Sie dieses Produkt in keiner Weise.
7. Das Produkt nicht direkt mit einem Gabelstapler anheben oder mit einem mechanischen Geräte.

MODELL UND PARAMETER

Modell	HXTC-3VD
Regaltyp	V-förmig (einseitig)
Anzahl der Regale	3
Max. Kapazität	110 Pfund/pro Regal
Material	Stahl
Farbe	Schwarz / Weiß

STRUKTURDIAGRAMM

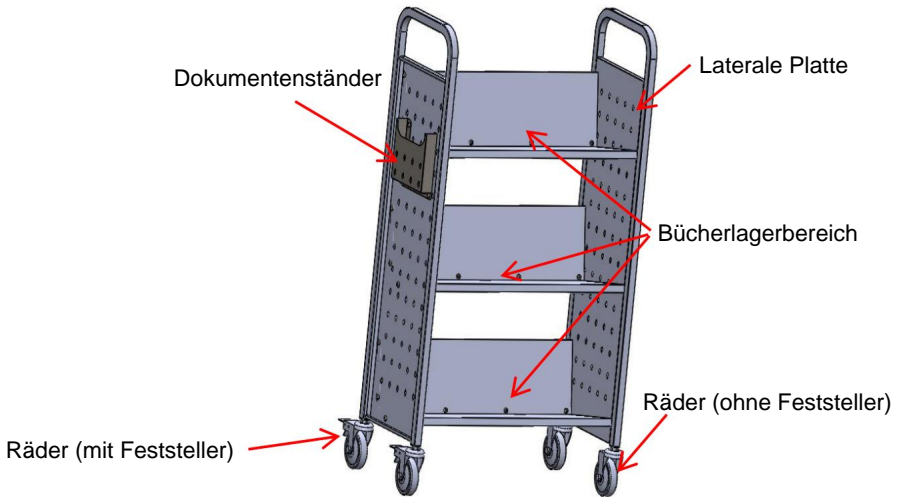

TEILELISTE

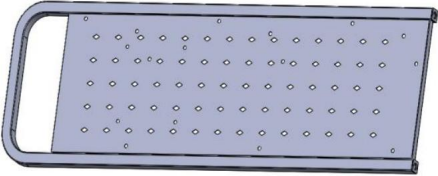
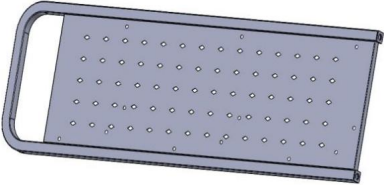
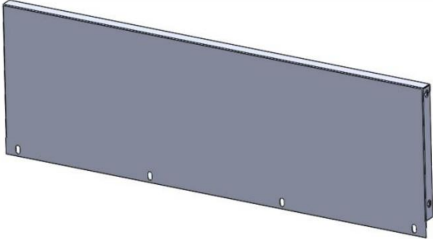
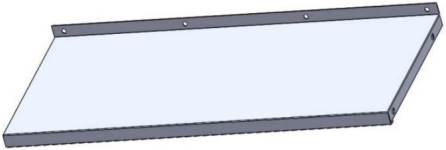
	
<p>Seitliche Platten x1</p>	<p>Seitliche Platten x1</p>
	
<p>Bücherregal-Rückwände x3</p>	<p>Bücherregal-Paneele x3</p>

	
<p>Räder (ohne Schloss) x2</p>	<p>Räder (mit Schloss) x2</p>
	
<p>Buchstützen x1</p>	<p>Dokumentenständer x1</p>
	
<p>1 x Inbusschlüssel</p>	<p>Hutmuttern (M6) x16</p>
	
<p>Schrauben (M6*8) x16</p>	<p>Schraubenschlüssel (10+19 mm) x2</p>
	
<p>Schrauben (M6*14) x24</p>	<p>Benutzerhandbuch x1</p>

INSTALLATION

HINWEIS: Diese Installation wird am besten von zwei Personen durchgeführt.

Schritt 1: Installieren Sie das Buchaufbewahrungspanel.

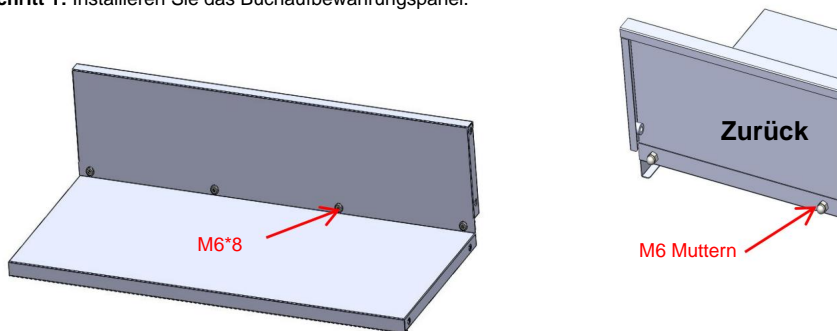

HINWEIS: Bitte ziehen Sie die Schrauben noch nicht fest.

Schritt 2: Installieren Sie die Seitenplatten.

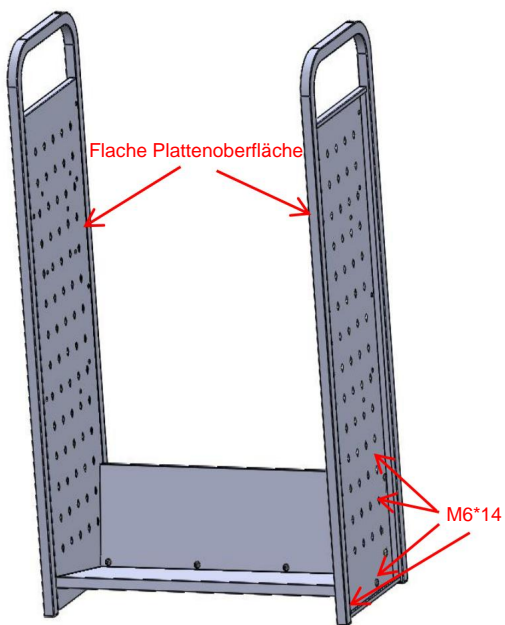

Schritt 3: Nachdem alle Teile montiert sind, stellen Sie den Winkel des Rahmens ein und ziehen Sie alle Schrauben fest.

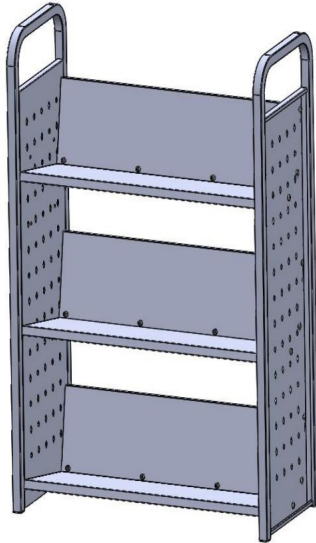

Schritt 4: Installieren Sie das Dokumentenregal.

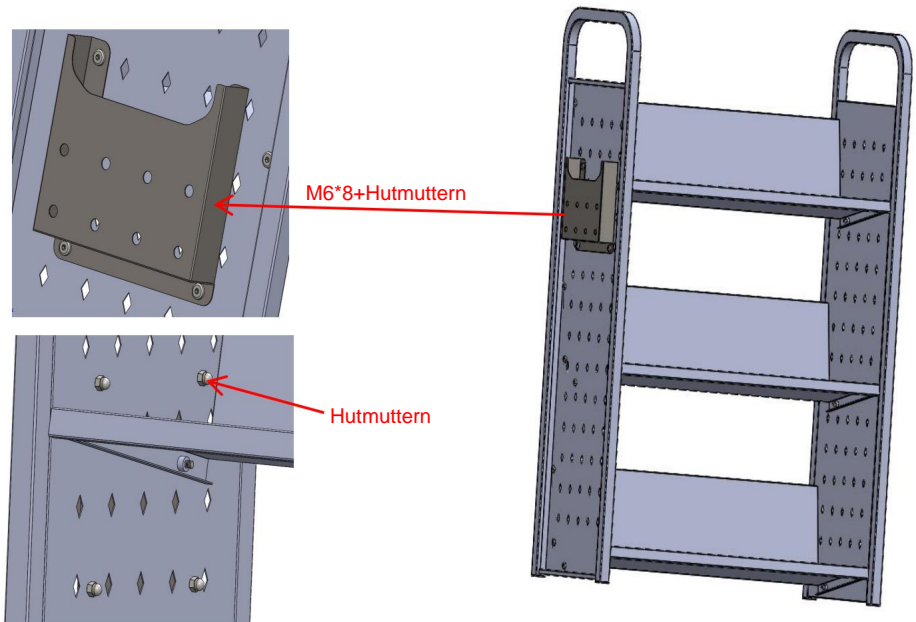

Schritt 5: Montieren Sie die vier Räder.

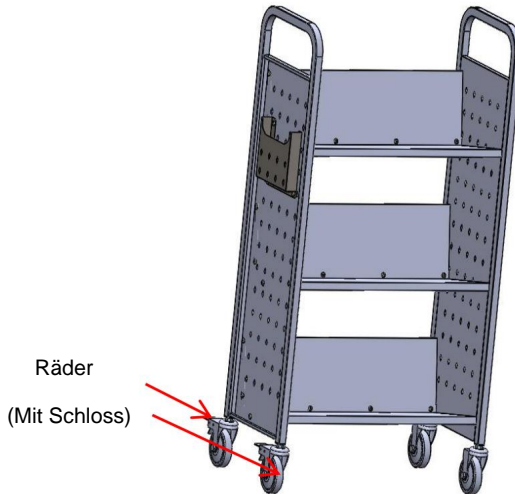

VERWENDUNG DER ROLLENBREMSE

• Zum Feststellen der Lenkrollen mit Feststellbremse die Hebel nach unten treten.

• Zum Entriegeln der Lenkrollen mit Feststellbremse die Hebel nach oben ziehen.

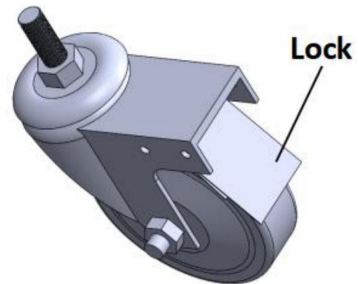
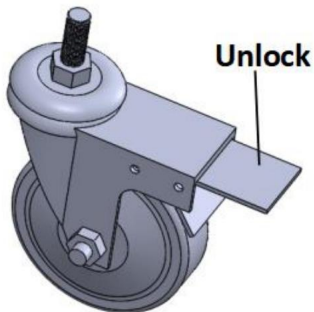

WARTUNG

1. Reinigen Sie die Oberfläche nach jedem Gebrauch.
Bitte überprüfen Sie vor jedem Gebrauch, ob der Wagen intakt ist.
2. Prüfen Sie, ob die Schrauben fest angezogen sind.
3. Radlager werden regelmäßig mit Fett geschmiert.

Hersteller: Shanghaimuxinmuyeyouxiangongsi **Adresse:**

Shuangchenglu 803nong11hao1602A-1609shi, baoshanqu, Shanghai 200000 CN.

Importiert nach AUS: SIHAO PTY LTD. 1 ROKEVA STREETEASTWOOD NSW 2122

Australien **Importiert in**

die USA: Sanven Technology Ltd. Suite 250, 9166 Anaheim Place, Rancho Cucamonga, CA 91730

Britische Republik	
---------------------------	--

YH CONSULTING LIMITED. C/O YH Consulting Limited,
Büro 147, Centurion House, London Road, Staines-upon-
Thames, Surrey, TW18 4AX

EG-Vertreter	
---------------------	--

E-CrossStu GmbH
Mainzer Landstr.69,
60329 Frankfurt am Main.



VEVOR

Affordable. Reliable. Home Improvement.

CARRELLI PORTA LIBRI

MODELLO: HXTC-3VD

VEVOR

Affordable. Reliable. Home Improvement.

CARRELLI PORTA LIBRI

MODELLO: HXTC-3VD

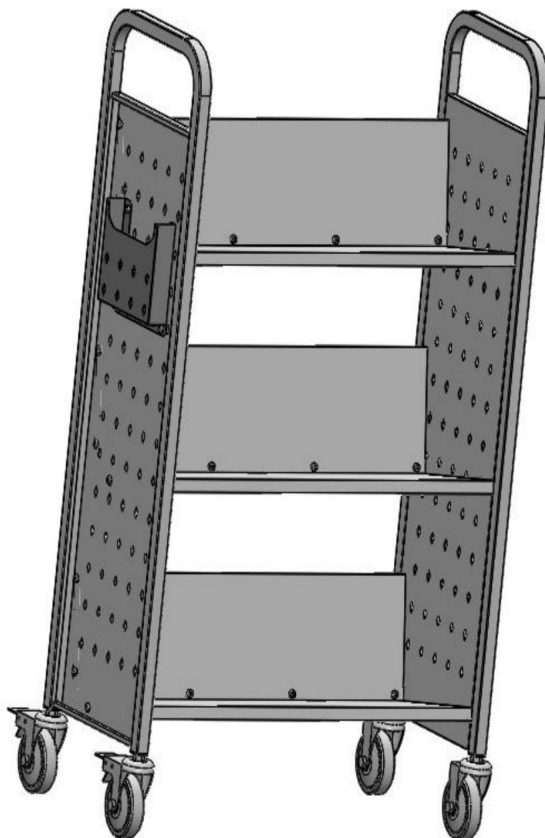

Queste sono le istruzioni originali, si prega di leggere attentamente tutte le istruzioni del manuale prima di utilizzare il prodotto. VEVOR si riserva la piena interpretazione del manuale utente. L'aspetto del prodotto dipenderà dal prodotto ricevuto. Vi preghiamo di non informarvi ulteriormente in caso di aggiornamenti tecnologici o software relativi al nostro prodotto.

ISTRUZIONI DI SICUREZZA

1. È vietato trasportare persone in qualsiasi condizione.
2. Tenere il prodotto su superfici piane. È vietato caricare oggetti su terreni irregolari e collinari. Il prodotto potrebbe diventare instabile e ribaltarsi se immagazzinato o spostato su una superficie non piana, il che potrebbe causare lesioni personali o danni al prodotto.
3. Il sovraccarico è severamente vietato.
4. Non procedere troppo velocemente quando si attraversano zone con buche.
5. Utilizzare i freni quando il prodotto non viene spostato. Ciò impedisce il prodotto dalla laminazione.
6. Non alterare in alcun modo il prodotto.
7. Non sollevare il prodotto direttamente con un carrello elevatore o trainarlo con qualsiasi mezzo meccanico dispositivi.

MODELLO E PARAMETRI

Modello	HXTC-3VD
Tipo di ripiano	A forma di V (monolaterale)
Numero di ripiani	3
Capacità massima	110 libbre/per ripiano
Materiale	Acciaio
Colore	Nero / Bianco

SCHEMA DELLA STRUTTURA

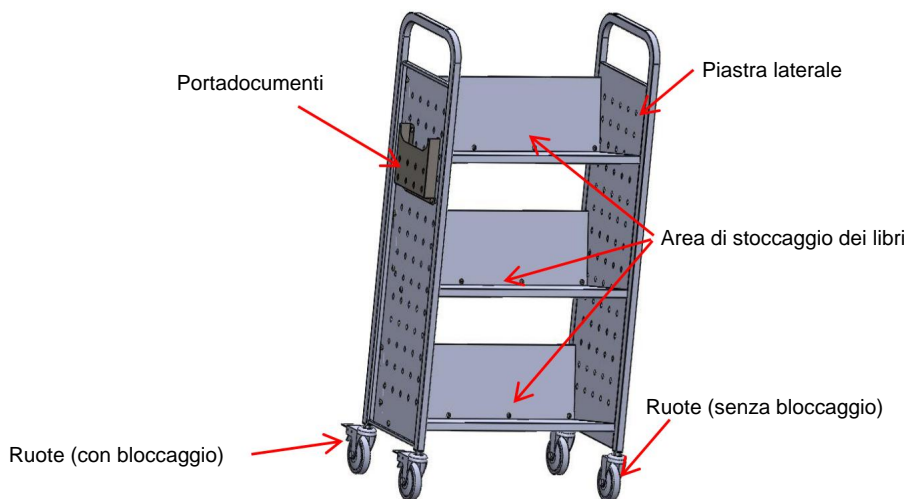

ELENCO DEI PEZZI

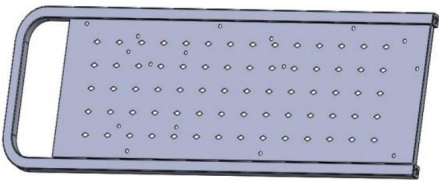
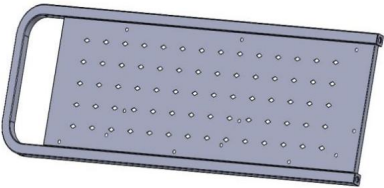
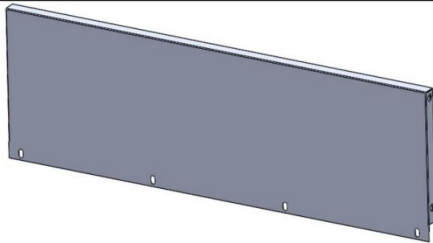
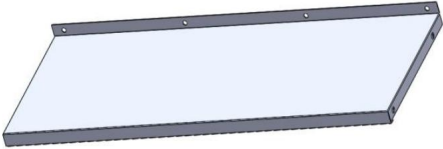
	
Piastre laterali x1	Piastre laterali x1
	
Pannelli posteriori per libreria x3	Pannelli portaoggetti per libri x3

	
<p>Ruote (senza bloccaggio) x2</p>	<p>Ruote (con bloccaggio) x2</p>
	
<p>Fernalibri x1</p>	<p>Portadocumenti x1</p>
	
<p>Chiave esagonale x1</p>	<p>Dadi a cappello (M6) x16</p>
	
<p>Bulloni (M6*8) x16</p>	<p>Chiavi (10+19 mm) x2</p>
	
<p>Bulloni (M6*14) x24</p>	<p>Manuale utente x1</p>

INSTALLAZIONE

NOTA: è consigliabile che questa installazione venga eseguita da due persone.

Fase 1: Installare il pannello di archiviazione dei libri.

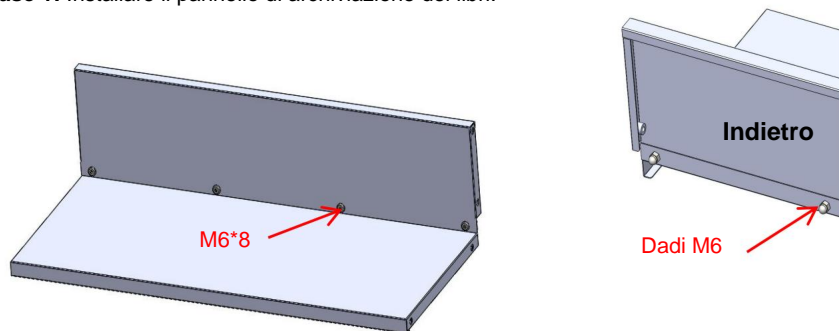

NOTA: non stringere ancora i bulloni.

Fase 2: installare le piastre laterali.

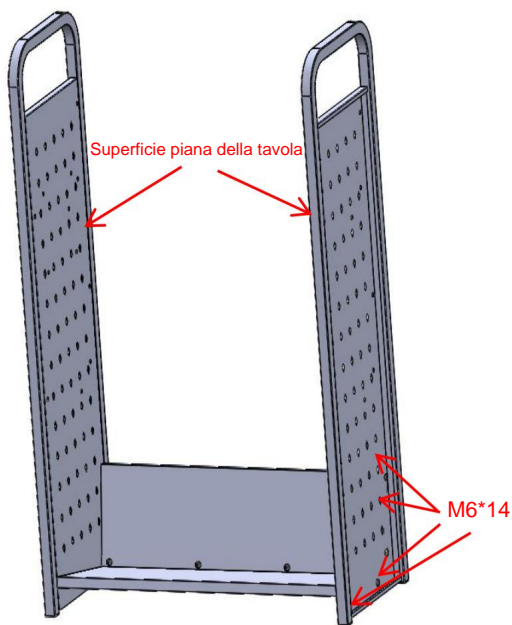

Fase 3: Dopo aver installato tutti i componenti, regolare l'angolazione del telaio e serrare tutti i bulloni.

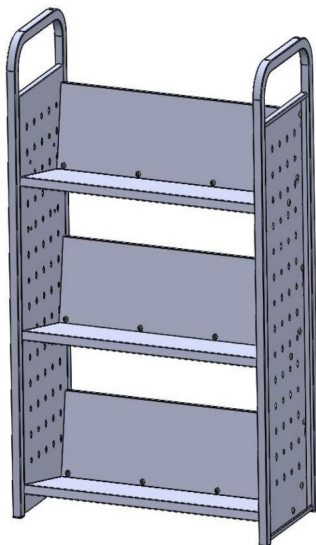

Fase 4: Installare il portadocumenti.

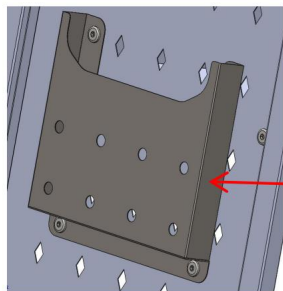

M6*8+dadi a cappello



Noci del cappello

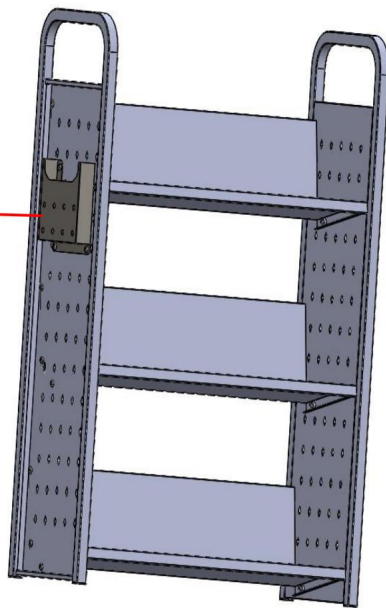

Fase 5: Installare le quattro ruote.

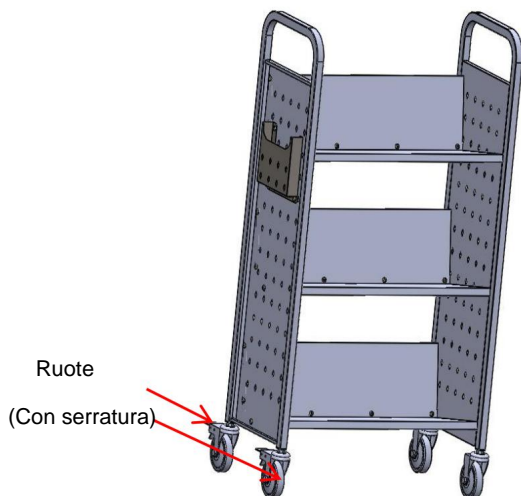

UTILIZZO DEL FRENO DELLE ROTAIE

ÿ Per bloccare le ruote girevoli con freno, abbassare le leve. ÿ Per sbloccare le ruote girevoli con freno, tirare le leve verso l'alto.

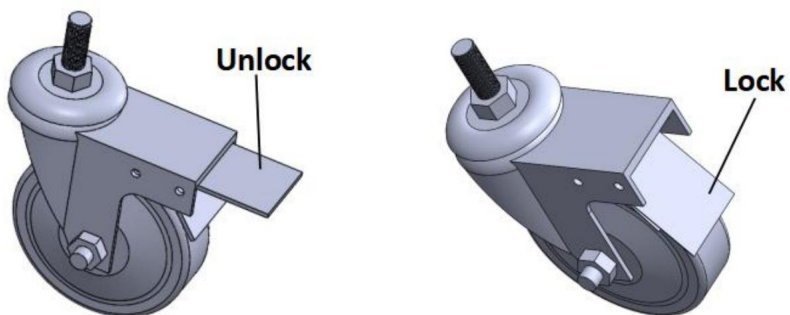

MANUTENZIONE

1. Pulire la superficie dopo ogni utilizzo.
Si prega di controllare e confermare che il carrello sia integro prima di ogni utilizzo.
2. Verificare che i bulloni siano ben serrati.
3. I cuscinetti delle ruote vengono regolarmente lubrificati con grasso.

Produttore: Shanghaimuxinmuyeyouxiangongsi **Indirizzo:**

Shuangchenglu 803nong11hao1602A-1609shi, baoshanqu, shanghai 200000 CN.

Importato in AUS: SIHAO PTY LTD. 1 ROKEVA STREETEASTWOOD NSW 2122

Australia **Importato negli**

USA: Sanven Technology Ltd. Suite 250, 9166 Anaheim Place, Rancho Cucamonga, CA 91730

RAPPRESENTANTE DEL REGNO UNITO	
--------------------------------	--

YH CONSULTING LIMITED. C/O YH Consulting Limited
Ufficio 147, Centurion House, London Road, Staines-
upon-Thames, Surrey, TW18 4AX

Rappresentante della CE	
-------------------------	--

E-CrossStu GmbH
Mainzer Landstr.69,
60329 Francoforte sul Meno.



VEVOR

Affordable. Reliable. Home Improvement.

CARRITOS DE LIBROS

MODELO: HXTC-3VD

VEVOR

Affordable. Reliable. Home Improvement.

CARRITOS DE LIBROS

MODELO: HXTC-3VD

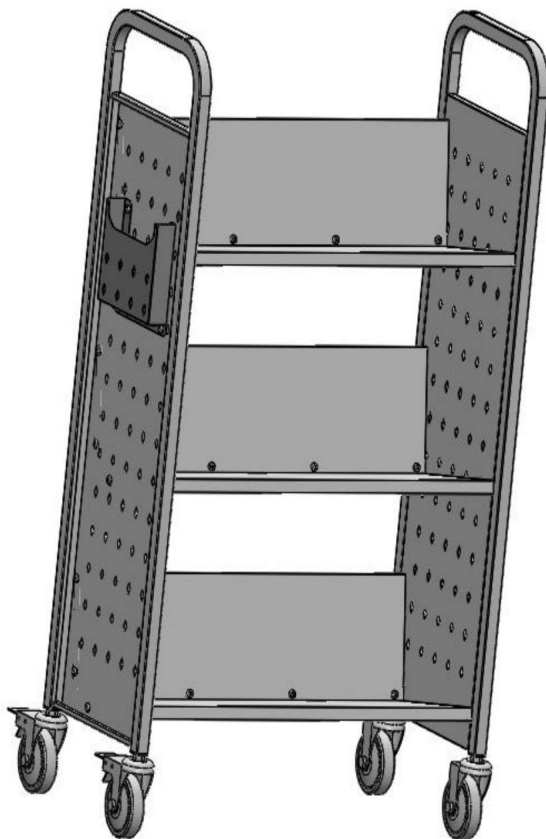

Estas son las instrucciones originales; lea atentamente todas las instrucciones del manual antes de utilizarlo. VEVOR se reserva el derecho de interpretar su manual de usuario. La apariencia del producto dependerá del producto que haya recibido. Le rogamos que nos disculpe si no le informamos de nuevo si hay actualizaciones tecnológicas o de software en nuestro producto.

INSTRUCCIONES DE SEGURIDAD

1. Está prohibido transportar personas bajo cualquier condición.
2. Mantenga el producto sobre superficies niveladas. Está prohibido cargar artículos sobre él. terrenos irregulares y montañosos. El producto puede volverse inestable y volcarse si almacenarse o trasladarse sobre una superficie desnivelada, lo que puede causar lesiones personales o daños al producto.
3. La sobrecarga está estrictamente prohibida.
4. No te muevas demasiado rápido al pasar por zonas con baches.
5. Utilice los frenos cuando este producto no se esté moviendo. Esto evita el producto se desplace.
6. No altere este producto de ninguna manera.
7. No levante el producto directamente con una carretilla elevadora ni lo remolque con ningún dispositivo mecánico. dispositivos.

MODELO Y PARÁMETROS

Modelo	HXTC-3VD
Tipo de estante	En forma de V (de un solo lado)
Número de estantes	3
Capacidad máxima	110 libras por estante
Material	Acero
Color	Negro / Blanco

DIAGRAMA DE ESTRUCTURA

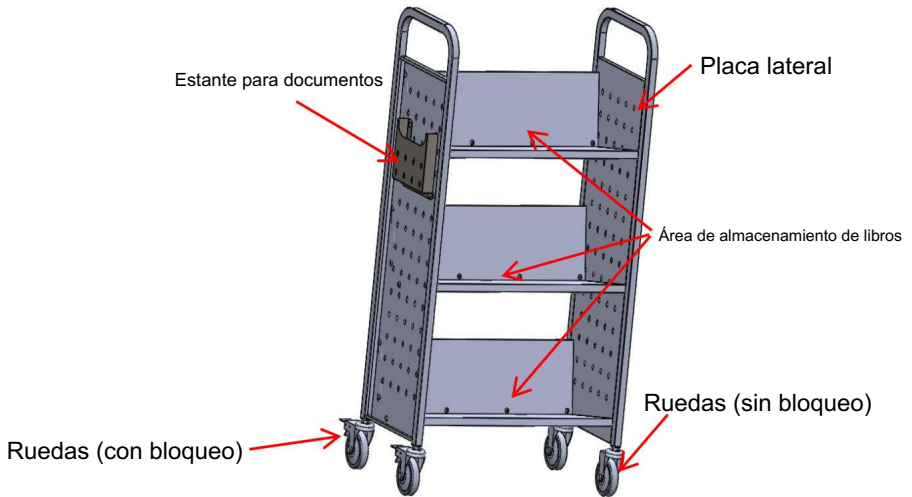

LISTA DE PIEZAS

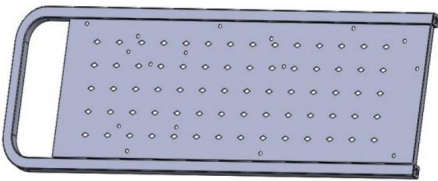
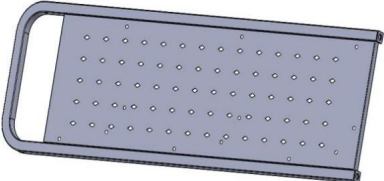
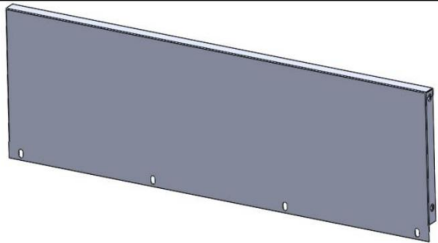
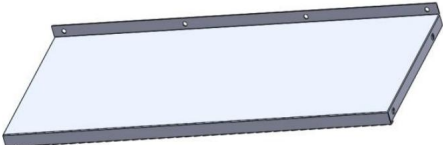
	
Placas laterales x1	Placas laterales x1
	
Tableros de estantería x3	Paneles de almacenamiento de libros x3

	
<p>Ruedas (sin bloqueo) x2</p>	<p>Ruedas (con bloqueo) x2</p>
	
<p>Sujetalibros x1</p>	<p>Estante para documentos x1</p>
	
<p>Llave hexagonal x1</p>	<p>Tuercas de sombrero (M6) x16</p>
	
<p>Pernos (M6*8) x16</p>	<p>Llaves (10+19 mm) x2</p>
	
<p>Pernos (M6*14) x24</p>	<p>Manual de usuario x1</p>

INSTALACIÓN

NOTA: Esta instalación se realiza mejor entre dos personas.

Paso 1: Instale el panel de almacenamiento de libros.

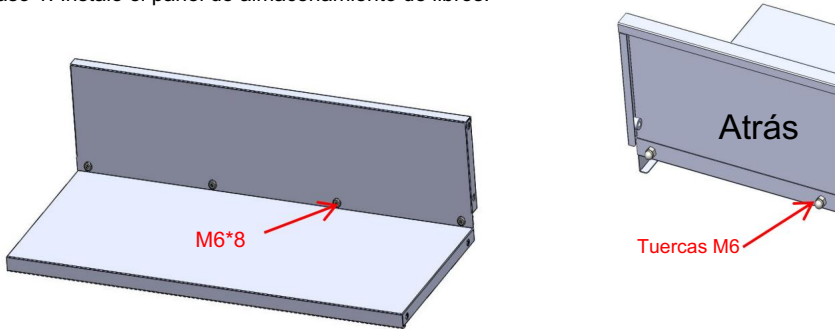

NOTA: No apriete los tornillos todavía.

Paso 2: Instale las placas laterales.

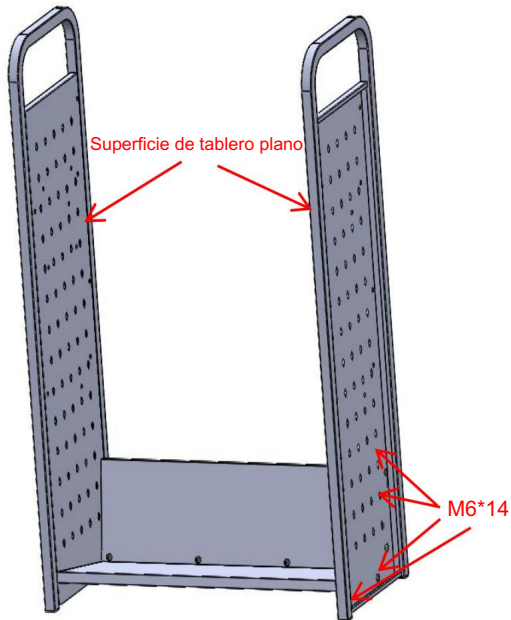

Paso 3: Después de instalar todas las piezas, ajuste el ángulo del marco y apriete todos los pernos.

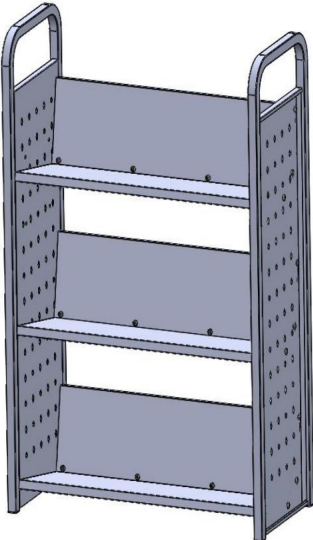

Paso 4: Instale el estante para documentos.

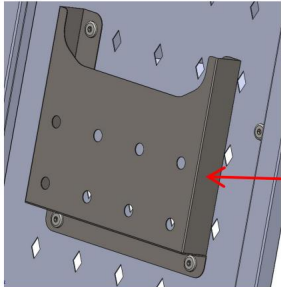

M6*8+Tuercas de sombrero



Tuercas de sombrero

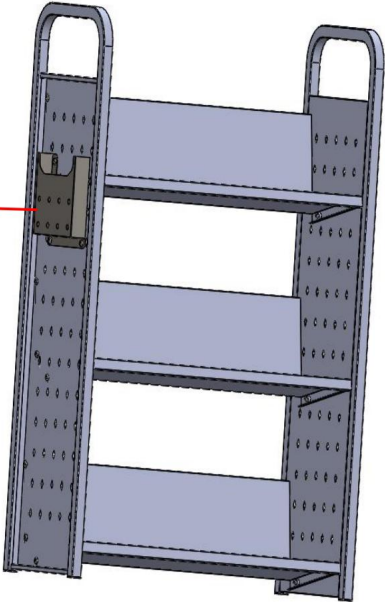

Paso 5: Instale las cuatro ruedas.



USO DEL FRENO DE RUEDAS

■ Para bloquear las ruedas giratorias con freno, baje las palancas. ■ Para desbloquear las ruedas giratorias con freno, tire de las palancas hacia arriba.

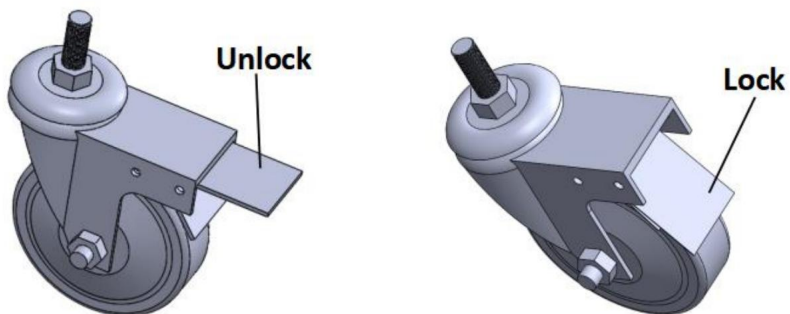

MANTENIMIENTO

1. Limpie la superficie después de cada uso.

Por favor, compruebe y confirme que el carrito esté intacto antes de cada uso.

2. Compruebe que los tornillos estén bien apretados.

3. Los cojinetes de las ruedas se lubrican periódicamente con grasa.

Fabricante: Shanghaimuxinmuyeyouxiangongsi Dirección:
Shuangchenglu 803nong11hao1602A-1609shi, baoshanqu, shanghai 200000 CN.

Importado a AUS: SIHAO PTY LTD. 1 ROKEVA STREET EASTWOOD NSW 2122
Australia Importado a

EE. UU.: Sanven Technology Ltd. Suite 250, 9166 Anaheim Place, Rancho Cucamonga,
CA 91730

REPRESENTANTE	DEL REINO UNIDO
---------------	-----------------

YH CONSULTING LIMITADA. A/C YH Consulting Limited
Oficina 147, Centurion House, London Road, Staines-
upon-Thames, Surrey, TW18 4AX

Representante	de la CE
---------------	----------

E-CrossStu GmbH
Mainzer Landstr.69,
60329 Fráncfort del Meno.



VEVOR

Affordable. Reliable. Home Improvement.

WÓZKI NA KSIĄŻKI

MODEL: HXTC-3VD

VEVOR

Affordable. Reliable. Home Improvement.

WÓZKI NA KSIĄŻKI

MODEL: HXTC-3VD

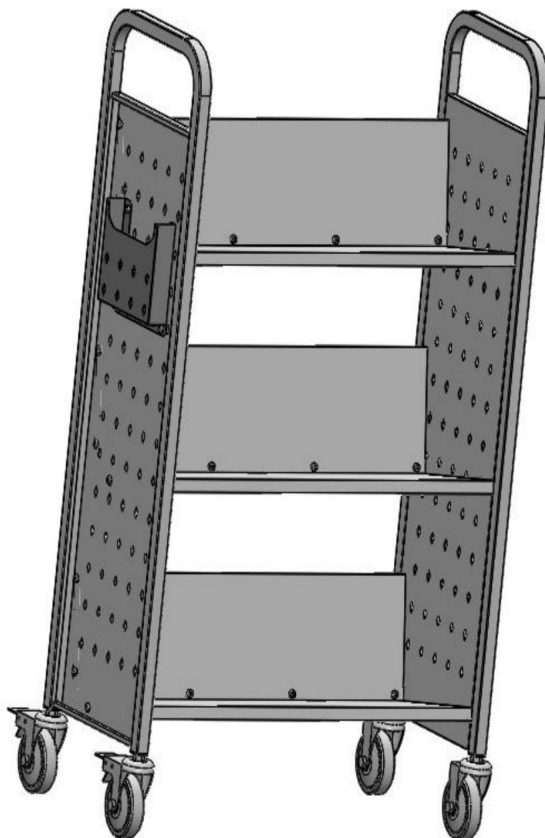

To jest oryginalna instrukcja, przed użyciem należy uważnie przeczytać wszystkie instrukcje. VEVOR zastrzega sobie jasną interpretację naszej instrukcji obsługi. Wygląd produktu będzie zależał od produktu, który otrzymałeś. Prosimy o wybaczenie, że nie poinformujemy Cię ponownie, jeśli w naszym produkcie pojawią się jakiegokolwiek aktualizacje technologiczne lub oprogramowania.

INSTRUKCJE BEZPIECZEŃSTWA

1. Zabrania się przewożenia osób w jakichkolwiek warunkach.
2. Przechowywać produkt na równych powierzchniach. Zabrania się ładowania przedmiotów na nierównym i pagórkowatym terenie. Produkt może stać się niestabilny i przewrócić się, jeśli przechowywane lub przenoszone na nierównej powierzchni, co może spowodować obrażenia ciała lub uszkodzenia produktu.
3. Przeciążanie jest surowo zabronione.
4. Nie poruszaj się zbyt szybko przy pokonywaniu dziur w drogach.
5. Używaj hamulców, gdy produkt nie jest w ruchu. Zapobiega to produkt uzyskany z walcowania.
6. Nie modyfikuj tego produktu w żaden sposób.
7. Nie należy podnosić produktu bezpośrednio wózkami widłowymi ani holować go przy użyciu jakichkolwiek urządzeń mechanicznych. urządzenia.

MODEL I PARAMETRY

Model	HXTC-3VD
Typ półki	W kształcie litery V (jednostronny)
Liczba półek	3
Maksymalna pojemność	110 funtów/półka
Tworzywo	Stal
Kolor	Czarny / Biały

SCHEMAT STRUKTURY

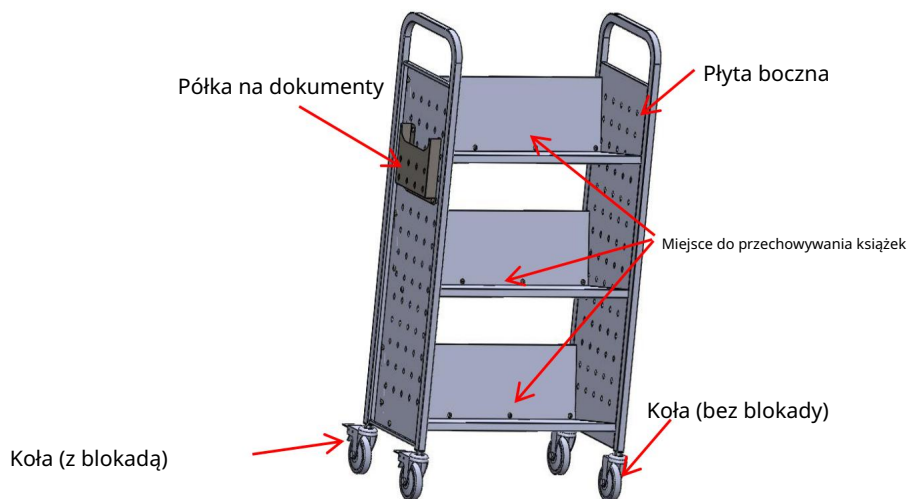

LISTA CZĘŚCI

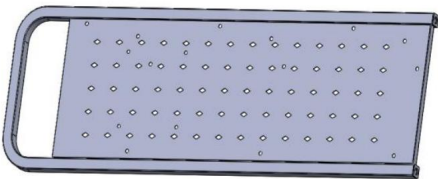
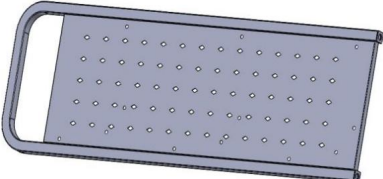
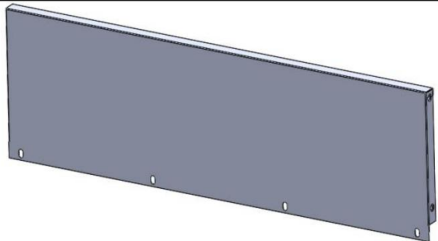
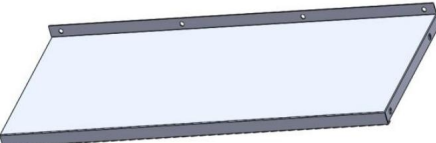
	
Płyty boczne x1	Płyty boczne x1
	
Tylne tablice regałów x3	Panele do przechowywania książek x3

	
<p>Koła (bez blokady) x2</p>	<p>Koła (z blokadą) x2</p>
	
<p>Podpórki do książek x1</p>	<p>Półka na dokumenty x1</p>
	
<p>Klucz imbusowy x1</p>	<p>Nakrętki kapeluszowe (M6) x16</p>
	
<p>Śruby (M6*8) x16</p>	<p>Klucze (10+19mm) x2</p>
	
<p>Śruby (M6*14) x24</p>	<p>Instrukcja obsługi x1</p>

INSTALACJA

UWAGA: Instalację najlepiej wykonać w dwie osoby.

Krok 1: Zainstaluj panel do przechowywania książek.

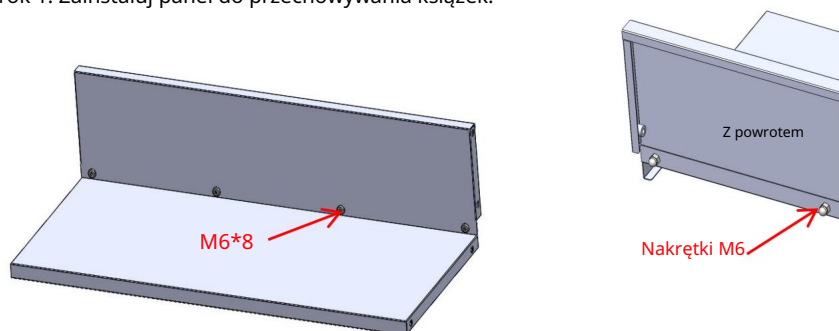

UWAGA: Proszę nie dokręcać jeszcze śrub.

Krok 2: Zamontuj płyty boczne.

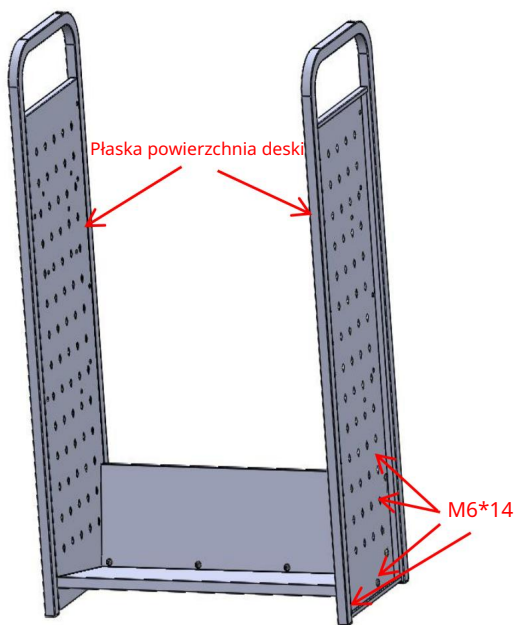

Krok 3: Po zamontowaniu wszystkich części należy dostosować kąt ramy i dokręcić wszystkie śruby.

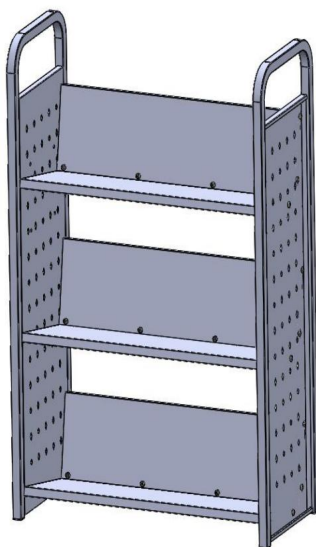

Krok 4: Zainstaluj półkę na dokumenty.

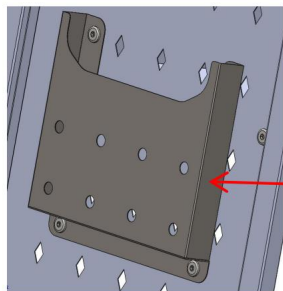

M6*8+Nakrętki kapeluszowe



Kapeluszowe orzechy

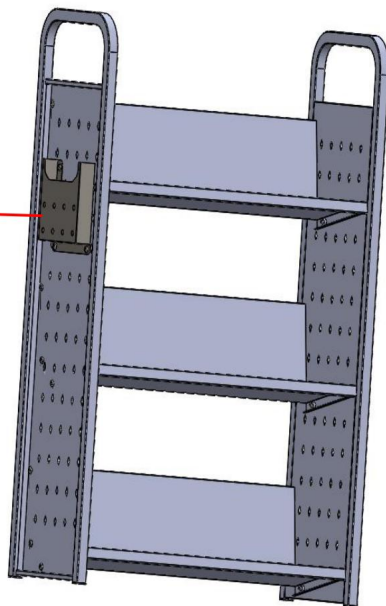

Krok 5: Zamontuj cztery koła.



UŻYWANIE HAMULCA KÓŁEK

Aby zablokować kółka obrotowe z hamulcem, należy nacisnąć dźwignię w dół.

Aby odblokować kółka obrotowe z hamulcem, należy pociągnąć dźwignię do góry.

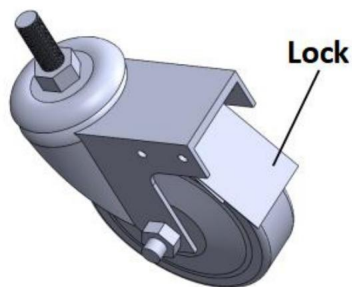
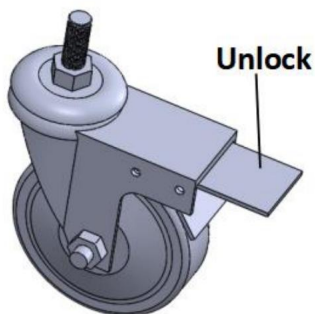

KONSERWACJA

1. Wyczyść powierzchnię po każdym użyciu.
Przed każdym użyciem należy sprawdzić i potwierdzić, czy wózek jest nienaruszony.
2. Sprawdź, czy śruby są dokręcone.
3. Łożyska kół należy regularnie smarować smarem.

Producent: Shanghai muxinmuyeyouxiangongsi Adres:

Shuangchenglu 803nong11hao1602A-1609shi, baoshanqu, szanghaj 200000 CN.

Importowane do AUS: SIHAO PTY LTD. 1 ROKEVA STREET EASTWOOD NSW 2122 Australia

Importowane do USA:

Sanven Technology Ltd. Suite 250, 9166 Anaheim Place, Rancho Cucamonga, CA 91730



YH CONSULTING LIMITED. C/O YH Consulting Limited Biuro
147, Centurion House, London Road, Staines-upon-
Thames, Surrey, TW18 4AX



E-CrossStu GmbH
Mainzer Landstr.69,
60329 Frankfurt nad Menem.



VEVOR

Affordable. Reliable. Home Improvement.

BOEKENWAGENS

MODEL: HXTC-3VD

VEVOR

Affordable. Reliable. Home Improvement.

BOEKENWAGENS

MODEL: HXTC-3VD

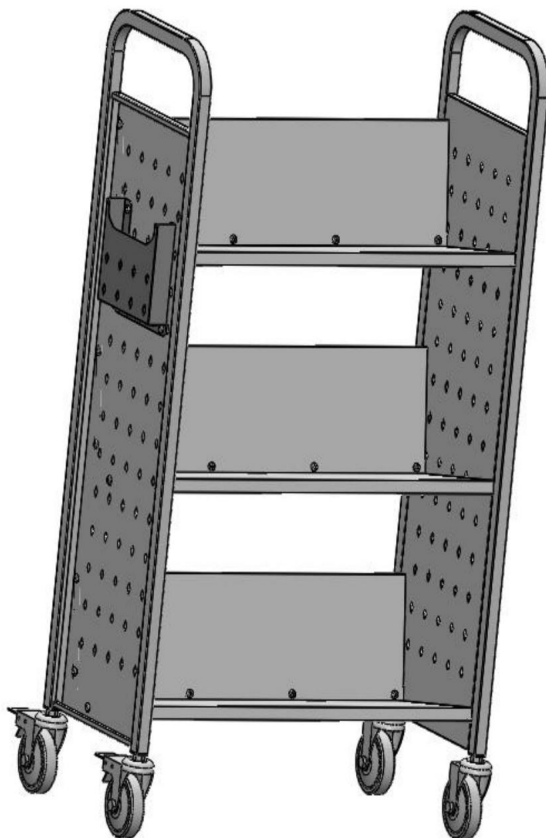

Dit is de originele handleiding. Lees alle instructies zorgvuldig door voordat u het product gebruikt. VEVOR behoudt zich het recht voor om de gebruiksaanwijzing duidelijk te interpreteren. Het uiterlijk van het product is afhankelijk van het product dat u hebt ontvangen. Neemt u het ons niet kwalijk dat we u niet meer op de hoogte stellen van eventuele technologische of software-updates voor ons product.

VEILIGHEIDSINSTRUCTIES

1. Het is verboden om personen te vervoeren, onder welke omstandigheden dan ook.
2. Plaats het product op een vlakke ondergrond. Het is verboden om artikelen op de grond te laden. oneffen en heuvelachtig terrein. Het product kan instabiel worden en kantelen als opgeslagen of verplaatst op een oneffen oppervlak, wat persoonlijk letsel kan veroorzaken of productschade.
3. Overbelasting is ten strengste verboden.
4. Rijd niet te snel bij het passeren van kuilen in de weg.
5. Gebruik de remmen wanneer dit product niet wordt verplaatst. Dit voorkomt het product van het rollen.
6. Breng op geen enkele wijze wijzigingen aan in dit product.
7. Til het product niet rechtstreeks op met een vorkheftruck of sleep het met een mechanische trekhaak. apparaten.

MODEL EN PARAMETERS

Model	HXTC-3VD
Planktype	V-vormig (enkelzijdig)
Aantal planken	3
Maximale capaciteit	110 pond/per plank
Materiaal	Staal
Kleur	Zwart/Wit

STRUCTUURDIAGRAM

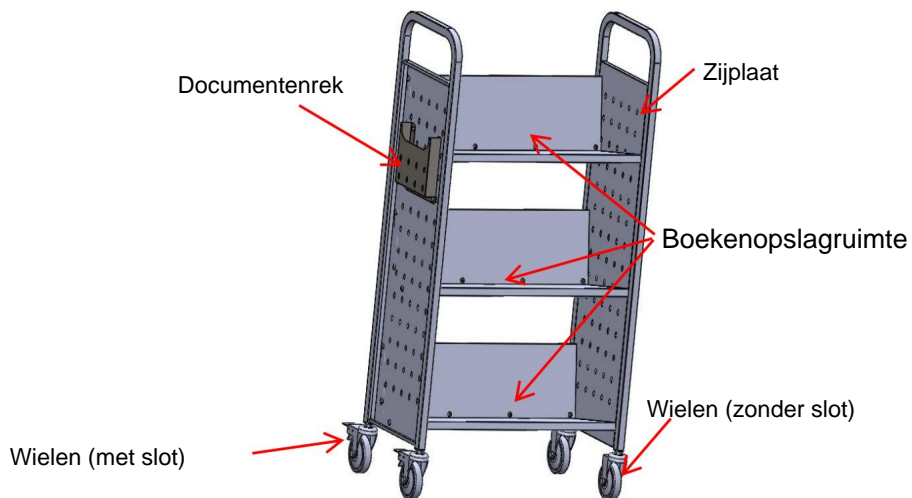

ONDERDELENLIJST

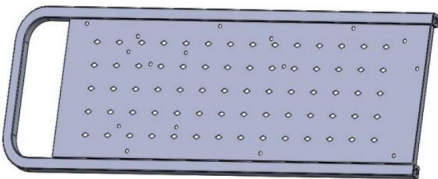
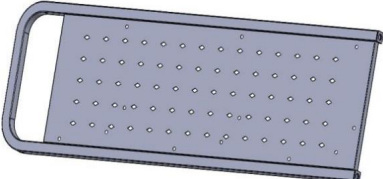
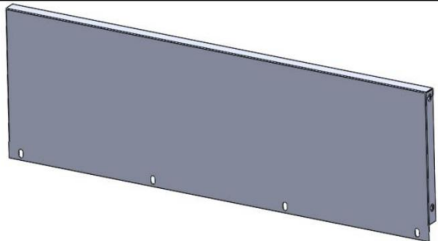
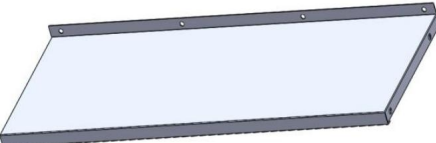
	
Zijplaten x1	Zijplaten x1
	
Boekenplank achterborden x3	Boekopslagpanelen x3

	
<p>Wielen (zonder slot) x2</p>	<p>Wielen (met slot) x2</p>
	
<p>Boekensteunen x1</p>	<p>Documentenrek x1</p>
	
<p>Inbussleutel x1</p>	<p>Hoedmoeren (M6) x16</p>
	
<p>Bouten (M6*8) x16</p>	<p>Sleutels (10+19mm) x2</p>
	
<p>Bouten (M6*14) x24</p>	<p>Gebruikershandleiding x1</p>

INSTALLATIE

LET OP: Deze installatie kan het beste door twee personen worden uitgevoerd.

Stap 1: Installeer het boekenopslagpaneel.

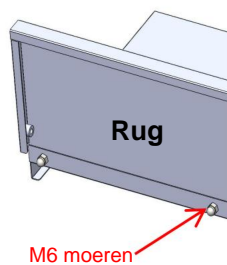
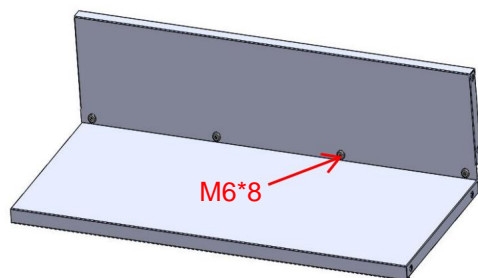

LET OP: Draai de bouten nog niet vast.

Stap 2: De zijplaten installeren.

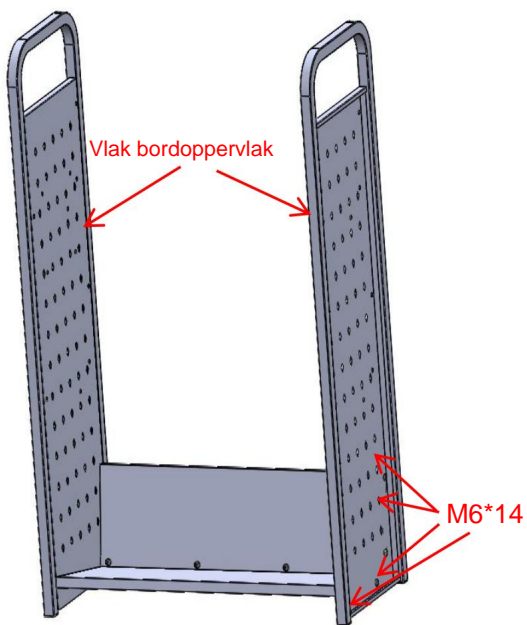

Stap 3: Nadat alle onderdelen zijn gemonteerd, past u de hoek van het frame aan en draait u alle bouten vast.

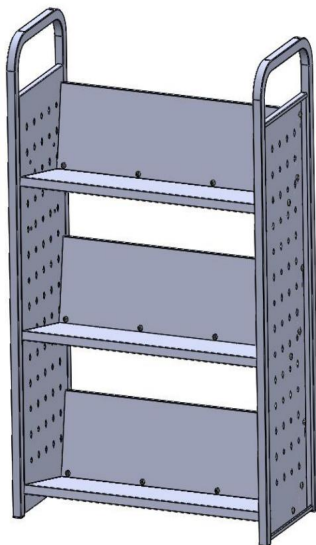

Stap 4: Installeer het documentenrek.

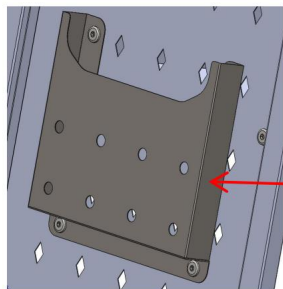

M6*8+Hoedmoeren



Hoednoten

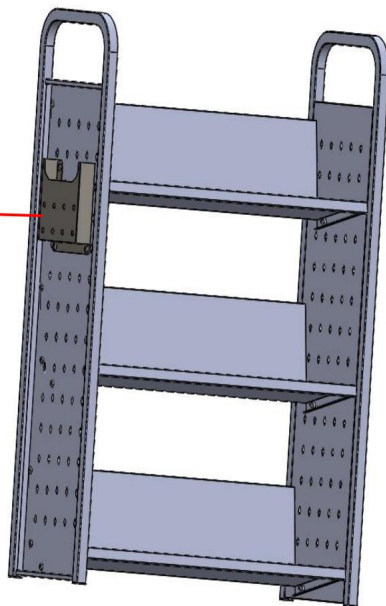

Stap 5: Monteer de vier wielen.

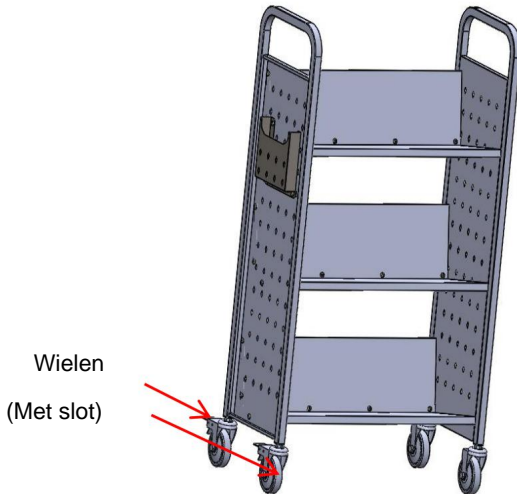

GEBRUIK VAN DE CASTERREM

ÿ Om de zwenkwielen met de rem te vergrendelen, duwt u de hendels naar beneden. ÿ Om de zwenkwielen met de rem te ontgrendelen, trekt u de hendels omhoog.

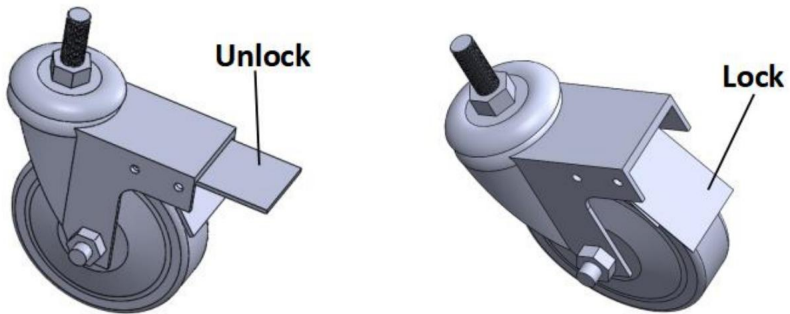

ONDERHOUD

1. Reinig het oppervlak na elk gebruik.
Controleer en bevestig vóór elk gebruik dat het winkelwagentje intact is.
2. Controleer of de bouten goed vastzitten.
3. Wiellagers worden regelmatig gesmeerd met vet.

Fabrikant: Shanghaimuxinmuyeyouxiangongsi **Adres:**

Shuangchenglu 803nong11hao1602A-1609shi, baoshanqu, shanghai 200000 CN.

Geïmporteerd naar Australië: SIHAO PTY LTD. 1 ROKEVA STREETEASTWOOD NSW
2122 Australië

Geïmporteerd naar de VS: Sanven Technology Ltd. Suite 250, 9166 Anaheim Place,
Rancho Cucamonga, CA 91730



YH CONSULTING LIMITED. T.a.v. YH Consulting Limited
Kantoor 147, Centurion House, London Road, Staines-
upon-Thames, Surrey, TW18 4AX



E-CrossStu GmbH
Mainzer Landstr.69,
60329 Frankfurt am Main.



VEVOR

Affordable. Reliable. Home Improvement.

BOKVAGNAR

MODELL: HXTC-3VD

VEVOR

Affordable. Reliable. Home Improvement.

BOKVAGNAR

MODELL: HXTC-3VD

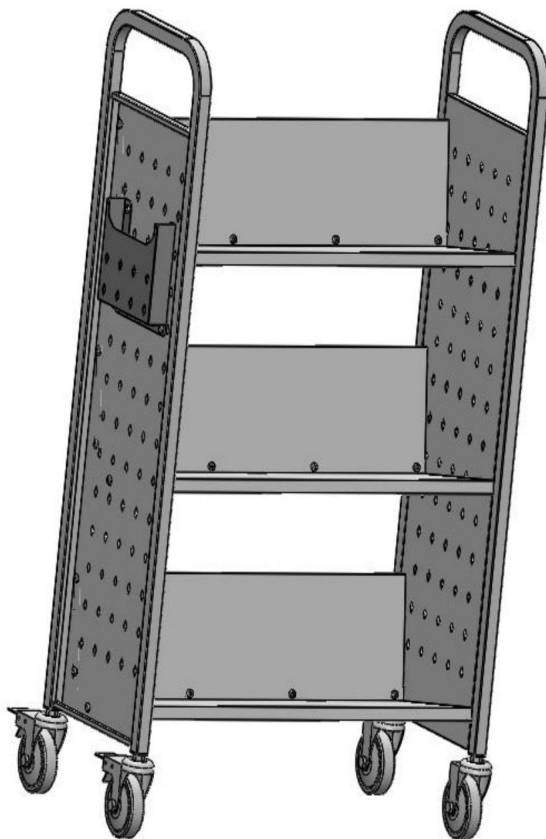

Detta är originalinstruktionerna, vänligen läs alla instruktioner noggrant innan du använder produkten. VEVOR förbehåller sig en tydlig tolkning av vår användarmanual. Produktens utseende ska vara beroende av den produkt du mottagit. Vi ber om ursäkt för att vi inte kommer att informera dig igen om det finns några teknik- eller programuppdateringar för vår produkt.

SÄKERHETSINSTRUKTIONER

1. Det är förbjudet att transportera människor under några omständigheter.
2. Förvara produkten på en plan yta. Det är förbjudet att lasta föremål på den ojämn och kuperad terräng. Produkten kan bli instabil och tippa om förvaras eller flyttas på en ojämn yta, vilket kan orsaka personskador eller produktskador.
3. Överbelastning är strängt förbjuden.
4. Kör inte för fort när du passerar områden med hål i vägen.
5. Använd bromsarna när produkten inte flyttas. Detta förhindrar produkten från att rullas.
6. Ändra inte denna produkt på något sätt.
7. Lyft inte produkten direkt med en gaffeltruck eller bogsera med någon mekanisk enheter.

MODELL OCH PARAMETRAR

Modell	HXTC-3VD
Hylltyp	V-formad (enkelsidig)
Antal hyllor	3
Maxkapacitet	110 pund/per hyllplan
Material	Stål
Färg	Svart / Vit

STRUKTURDIAGRAM

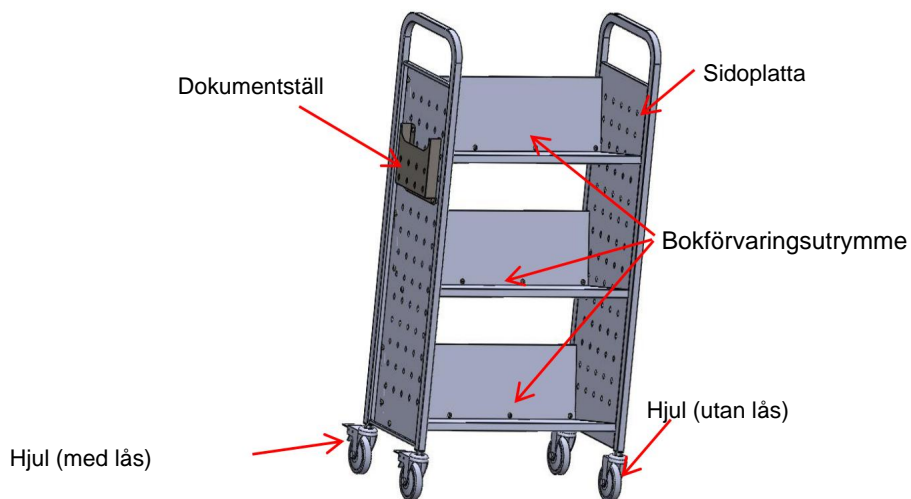

DELLISTA

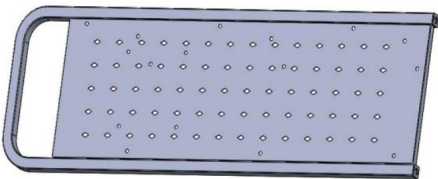
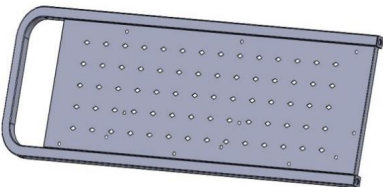
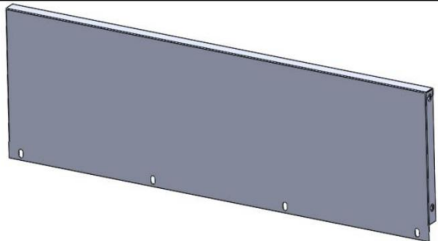
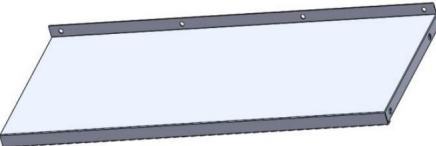
	
Sidoplatlor x1	Sidoplatlor x1
	
Bakre brädor för bokhyllor x3	Bokförvaringspaneler x3

	
<p>Hjul (utan lås) x2</p>	<p>Hjul (med lås) x2</p>
	
<p>Bokstöd x1</p>	<p>Dokumentställ x1</p>
	
<p>Sexkantsnyckel x1</p>	<p>Hattmuttrar (M6) x16</p>
	
<p>Bultar (M6*8) x16</p>	<p>Skiftnycklar (10+19 mm) x2</p>
	
<p>Bultar (M6*14) x24</p>	<p>Användarmanual x1</p>

INSTALLATION

OBS: Denna installation utförs bäst av två personer.

Steg 1: Montera bokförvaringspanelen.

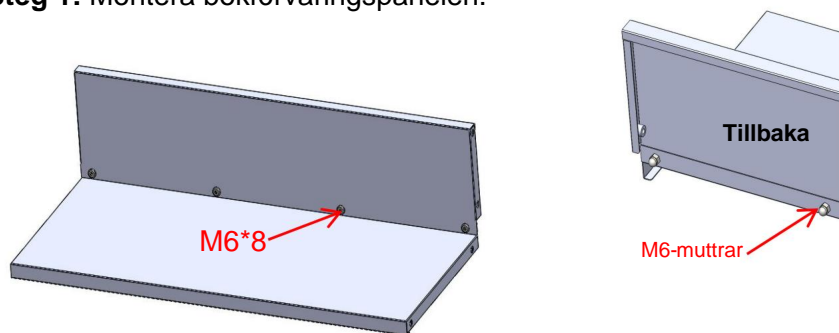

OBS: Dra inte åt bultarna ännu.

Steg 2: Montera sidoplattorna.

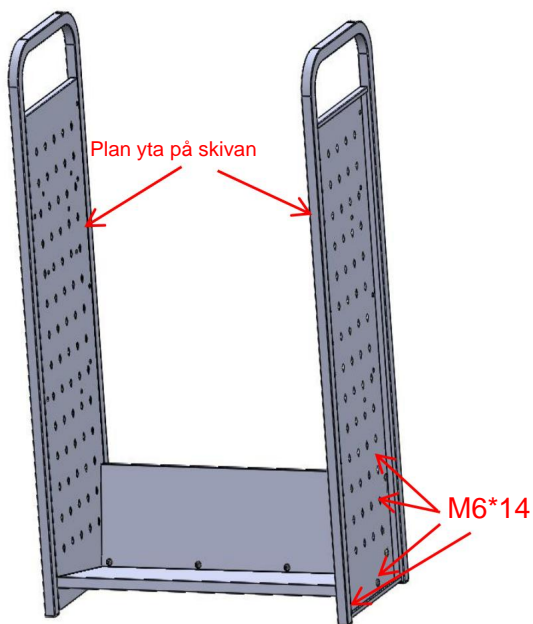

Steg 3: När alla delar är monterade, justera ramens vinkel och dra åt alla bultar.

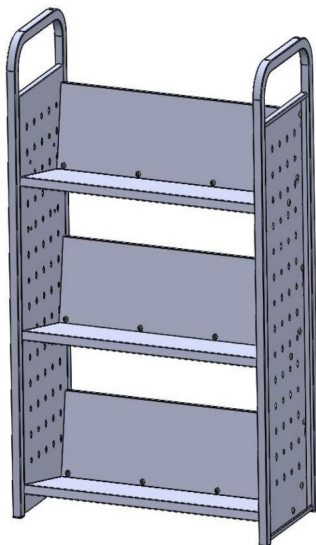

Steg 4: Installera dokumentstället.

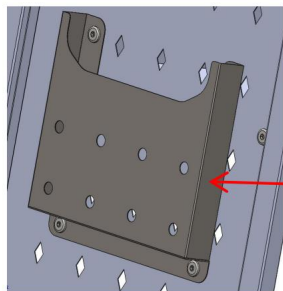

M6*8+hattmuttrar



Hattnötter

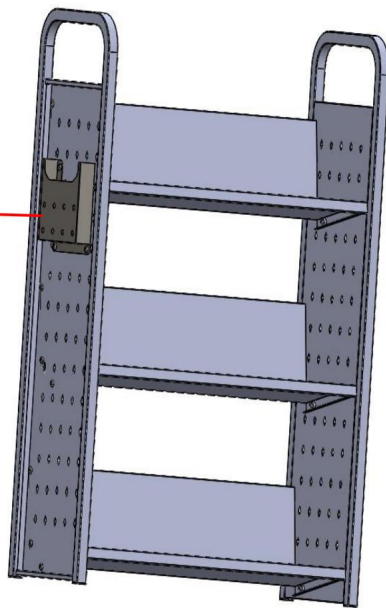

Steg 5: Montera de fyra hjulen.

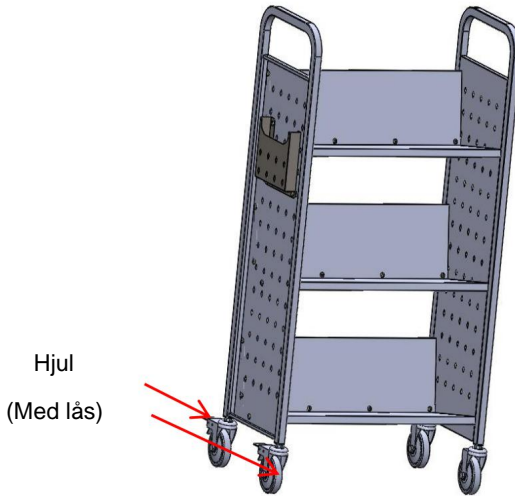

ANVÄNDA HJULBROMSEN

ÿ För att låsa länkhjulen med broms, trampa ner spakarna. ÿ För att låsa upp länkhjulen med broms, dra upp spakarna.

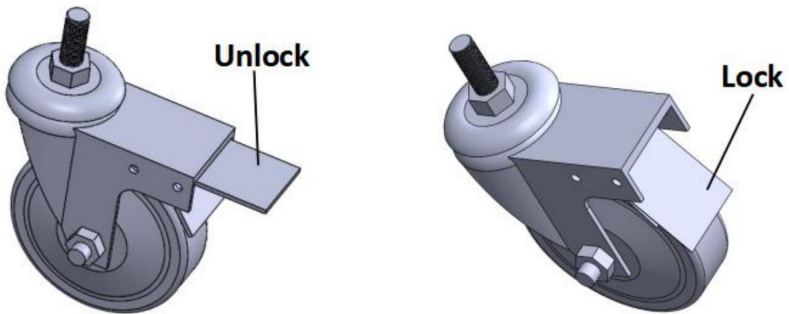

UNDERHÅLL

1. Rengör ytan efter varje användning.
Kontrollera och bekräfta att vagnen är intakt före varje användning.
2. Kontrollera att bultarna är åtdragna.
3. Hjullager smörjs regelbundet med fett.

Tillverkare: Shanghai muxinmuyeyouxiangongsi **Adress:**

Shuangchenglu 803nong11hao1602A-1609shi, baoshanqu, shanghai 200000 CN.

Importerad till Australien: SIHAO PTY LTD. 1 ROKEVA STREET EASTWOOD NSW
2122 Australien

Importerad till USA: Sanven Technology Ltd. Suite 250, 9166 Anaheim Place, Rancho
Cucamonga, CA 91730

Storbritanniens republikaner	
------------------------------	--

YH CONSULTING LIMITED. C/O YH Consulting Limited
Kontor 147, Centurion House, London Road, Staines-
upon-Thames, Surrey, TW18 4AX

EG-representant	
-----------------	--

E-CrossStu GmbH
Mainzer Landstr.69,
60329 Frankfurt am Main.

