

# L2544 Laser Engraving Machine

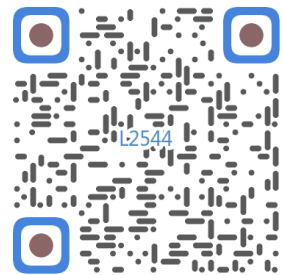













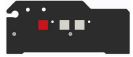



## Warning

- Strictly prohibit laser radiation of the eyes!
- Strictly prohibit watching laser without wearing protective glasses!
- Strictly prohibit using by children!
- Strictly prohibit using this machine unattended!



Scan for assemble video

**1. Parts List**

<b>L2544 Parts List</b>				
Part No	Part Name	Explanation	Quantity	Picture
01	Y-axis component	Already assembled	1Set	
02	X-axis component	Already assembled	1Set	
03	Control board component	Already assembled	1Set	
	Wiring harness and protective pipe	—	1Set	/
04	Leg	—	1	
05	Inner hexagon screw	M5×12	4	
06	Manual nut	M5	4	
07	Cable ties	—	2	
08	Power supply and power line	12V DC	1	
09	Inner Hexagon Wrench	4/2.5/2mm	1Set	
10	USB cable	—	1	
11	Protective glass	—	1	
12	non-slip mat	—	1	/
13	Card reader	—	1	/
14	Instruction manual	—	1	/
<b>Laser package (Optional)</b>				
L1	Laser kit	Optional	1Set	/
M1	Component for lifting bracket	Already assembled	1Set	
M2	Acrylic plate B for X-Part	for laser	1	
M3	Inner hexagon screw	M3×10	2	
M4	Cross screw	M3×6	2	
M5	Cross screwdriver	—	1	

## 2. Machine Assembly

### ① Y-axis and X-axis component assembly

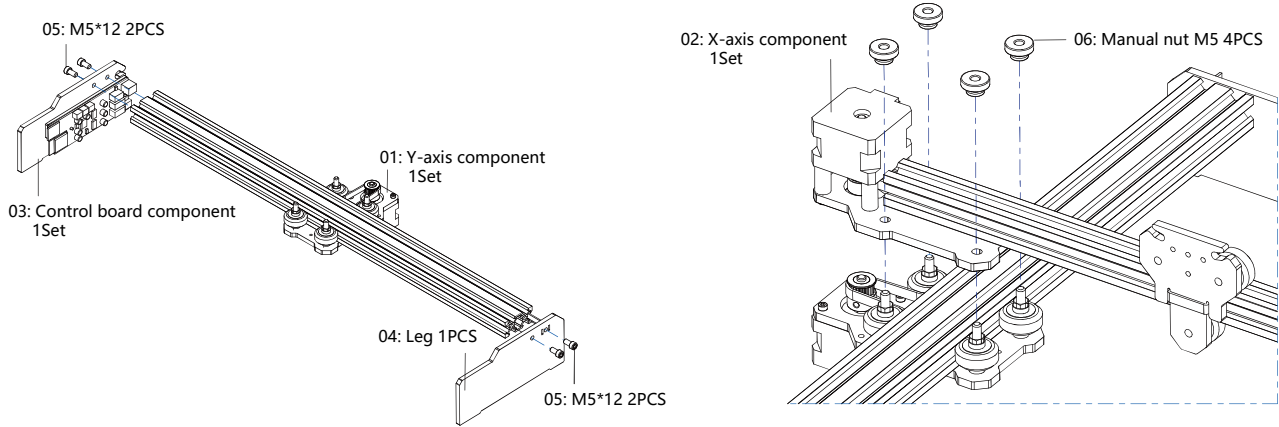

### ② Assembly of lifting bracket

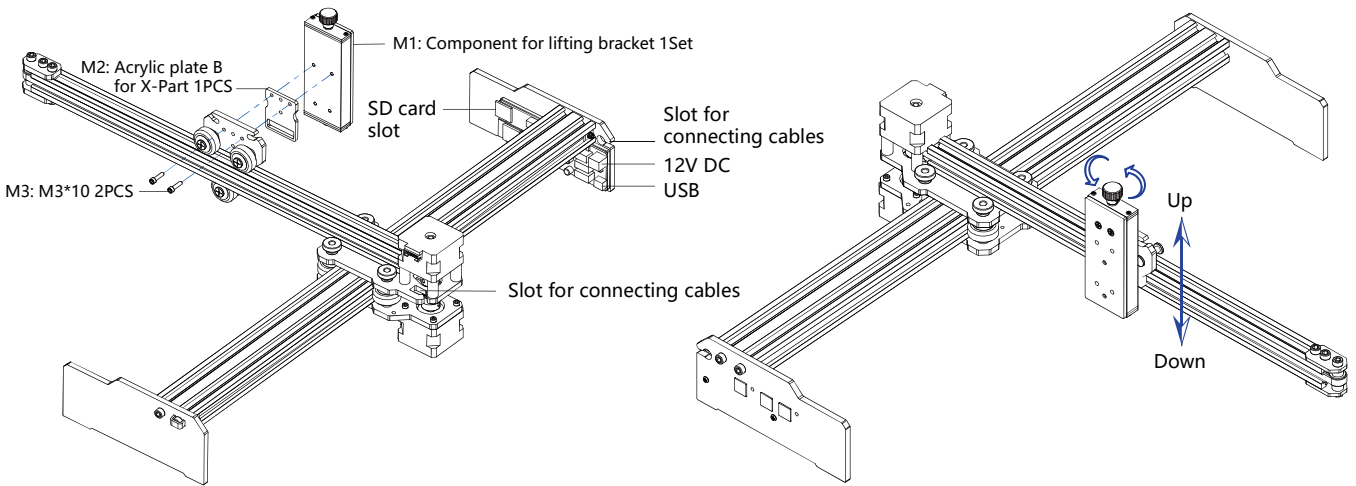

### ③ Laser Installation

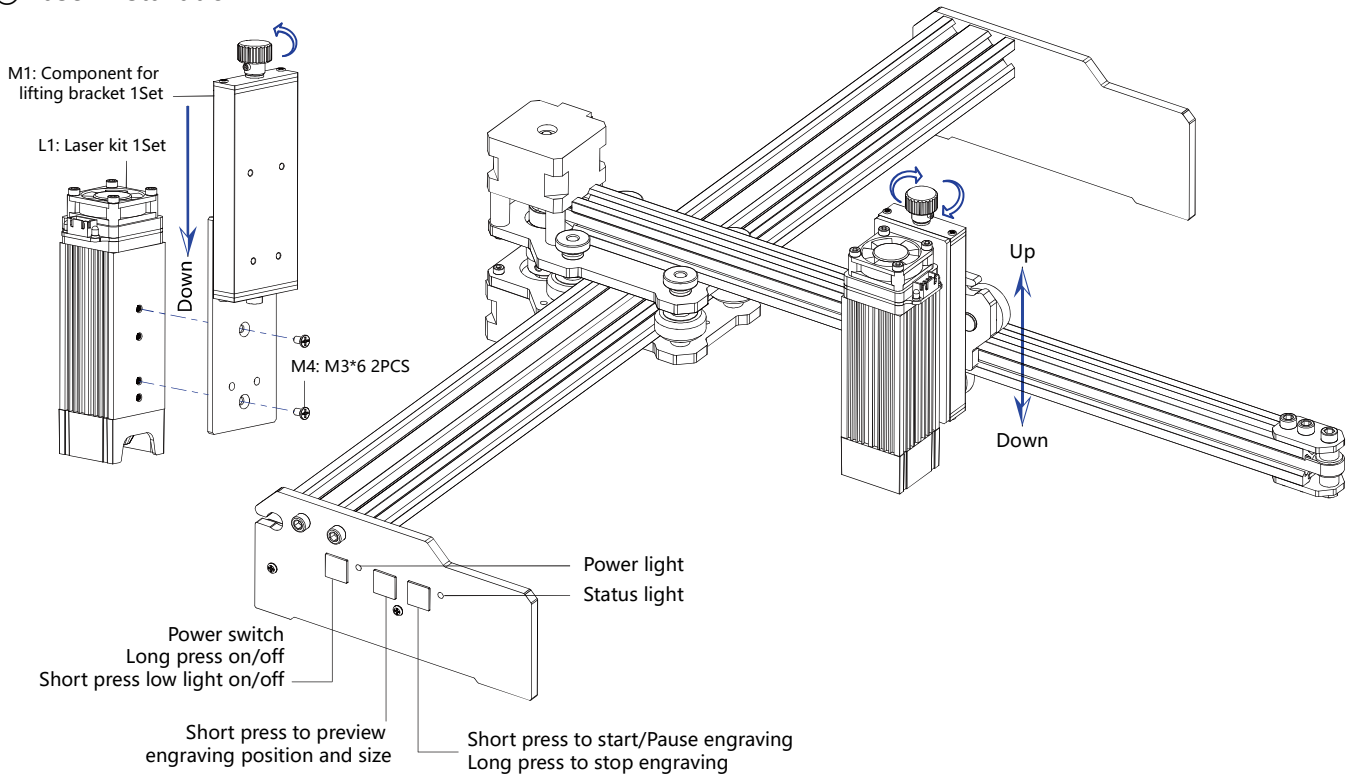

## 5. Download and run the engraving control software “VevorWorks”

Open our website [www.vevorengraver.com](http://www.vevorengraver.com).

Find the control software for L2544, then click to download it to your computer.

Green software doesn't need to be installed. Decompress the file you downloaded just now. The software running OS is Win7 Win8 and Win10.

Open the fold and double-click the VevorWorks.exe file to run the engraving software. The OS may prompt that the software will use the network, please click OK (some computer systems do not prompt, if the software cannot use the network, please allow it manually in the firewall setup).

In addition, the machine also supports Wi-fi connection control engraving on smartphone or iPad. You can also install **VevorWorks (For Android or iOS)** on your phone or iPad to control the engraving machine. The following is the using of windows version software. **The machine also supports the engraving software of the third-party standard GRBL, such as LaserGrbl, LightBurn, etc**

## 6. Connect VevorWorks software and laser engraving machine

Long press the power button on the machine panel to turn on it. There are three ways to connect engraving software and the machine.

### (1) USB-Serial Connection

Connect the USB-Serial cable to both control board and computer. In general, Win10 can automatically identify the device. Win7 or other OS may need to install driver manually. Please double click **ch341ser.exe** to install the driver if necessary. Click **Connect** on top left corner of VevorWorks, **SERIAL-ON** will be displayed in the title bar, indicating that the connection is successful.

### (2) Machine establish Wi-Fi Hotspot Wireless Connection

If the USB cable is connected, be sure to disconnect it.

After the machine turned on, the blue signal light will double flash. It indicates that the machine has established the Wi-Fi hotspot named VIGO-ESPXXX (Where "XXXX" is its name).

Turn on the wireless network settings of the computer system, and choose to connect VIGO-ESPXXX with password **12345678**. Click **Connect** on left up corner of VevorWorks. Users will be reminded finding device VIGO-ESPXXX, click **OK** to connect, and **WLAN-ON** will be displayed on the title bar, indicating that the connection is successful. Please note that users cannot visit internet in this mode.

### (3) Wireless LAN Connection

You are recommended to place the machine and router in the same room when using this connection.

The machine does not support 5G signal WLAN, so please send 2.4G signal SSID to control board. Usually use the SSID name without "5G".

When **VevorWorks** has connected to the machine by **hotspot**, then click **Settings**; click the **Network** at the bottom left. Input the **SSID (No 5G)** and **Password**, and click **Send**. The control board will restart automatically after receive the account successfully. Please make sure to use the **2.4G** WLAN for control board. After restart (generally 2-5s), the single flashing of the signal light indicates the successful access to WLAN. If the USB cable is connected, be sure to disconnect it.

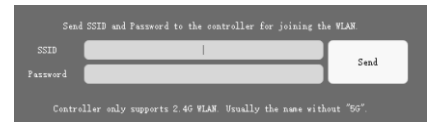

Reset the wireless network of the computer to join the same WLAN (It is ok for computer to use whether 2.4G or 5G signal). The title bar of **VevorWorks** will show the name of WLAN. Click **Connect** on VevorWorks. Users will be reminded that find device VIGO-ESPXXX, click **OK** to connect, and **WLAN-ON** will be displayed on the title bar, indicating that the connection is successful. **Once the machine connected WLAN successfully, Please notice that the machine will connect to this WLAN firstly every time you start it in the future.** If the connection fails, the machine will still establish the wireless hotspot VIGO-ESPXXX. If the connection fails, please check whether the 2.4G name and password you send are correct, and try again.

## 7. Adjust focus

Please use the focal length measuring piece to adjust the module height so that the distance from the lower edge of the module protective cover to the engraved object is equal to the height of the measuring piece.

## 8. Open or input the engraving content and adjust the engraving parameters

Engraving content can be opened at the top of the software image or gallery, or edit the engraving text.



Set the start location of engraving and adjust the size of engraving.

Select one of the engraving modes. There two engraving mode, line mode and point mode, which can respectively engrave black-and-white images, grayscale images and outlines. (only line engraving is supported for outline, please use outline when cutting objects.)

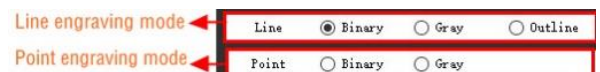

Set engraving parameters. There are four engraving parameters that can be set. These parameters will affect the engraving speed and engraving effect. It is necessary for you to understand the function of these parameters and adjust them according to different engraving materials and contents.

(1) Line engraving speed: Set the engraving speed (only valid for line engraving mode). Note that the set speed may not be reached when the image is too small or the dot distance is too dense.



(2) Maximum laser power: Set the maximum laser power, which is the laser power when the maximum gray level (i.e. all black) in the dot matrix gray mode and line scan gray mode and the laser power in the Binary (black and white) engraving mode. The unit is the



percentage of the installed laser full power.

(3) Engraving point distance: set the precision of dot matrix engraving or line scanning engraving, and the number of lines or points per millimeter.



(4) Time of dot engraving: Set the engraving time of each dot. The unit is millisecond. According to the power of the laser module and engraving material, we generally recommend to set about 1ms to 5ms.



**9. Preview the engraving range and start engraving**

Click **Range preview** to confirm the position and range of engraving. Click **Start** and wait for the engraving to be completed. In the wireless connection state, you can also click **Upload File**, and the engraving file will be uploaded to the SD card of the control board. You can use the offline engraving function provided by this machine to complete engraving.

**10. Offline engraving**

Before using offline engraving, please make sure that the engraving file has been uploaded to the SD card of the control board (please refer to the file upload in the previous step, the upload function is only available in wireless connection). Press the **Button A** on the side panel of the machine to start the preview. During the preview progress, press the **Button A** to stop the preview. During preview, pressing **Button B** will immediately start engraving. When the system is idle or offline preview, press **Button B** to start engraving, press **Button B** again to pause engraving, and press **Button B** again to resume engraving. During engraving or pause, press and hold **Button B** to stop engraving.

**Note:** When the wireless network signal is unstable or the computer is unstable, the uploading may fail. If the uploading engraving file fails, you can export the engraving file to the computer and copy it to the SD card, and then insert the SD card into the engraving machine for offline engraving. Please ensure that the file name exported and copied is **SD\_default.nc**.

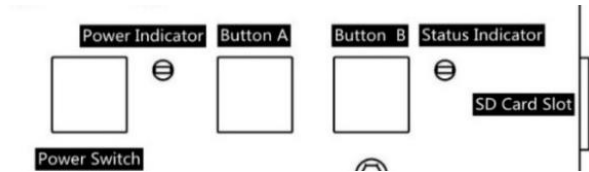

**11. Introduction of software interface function**

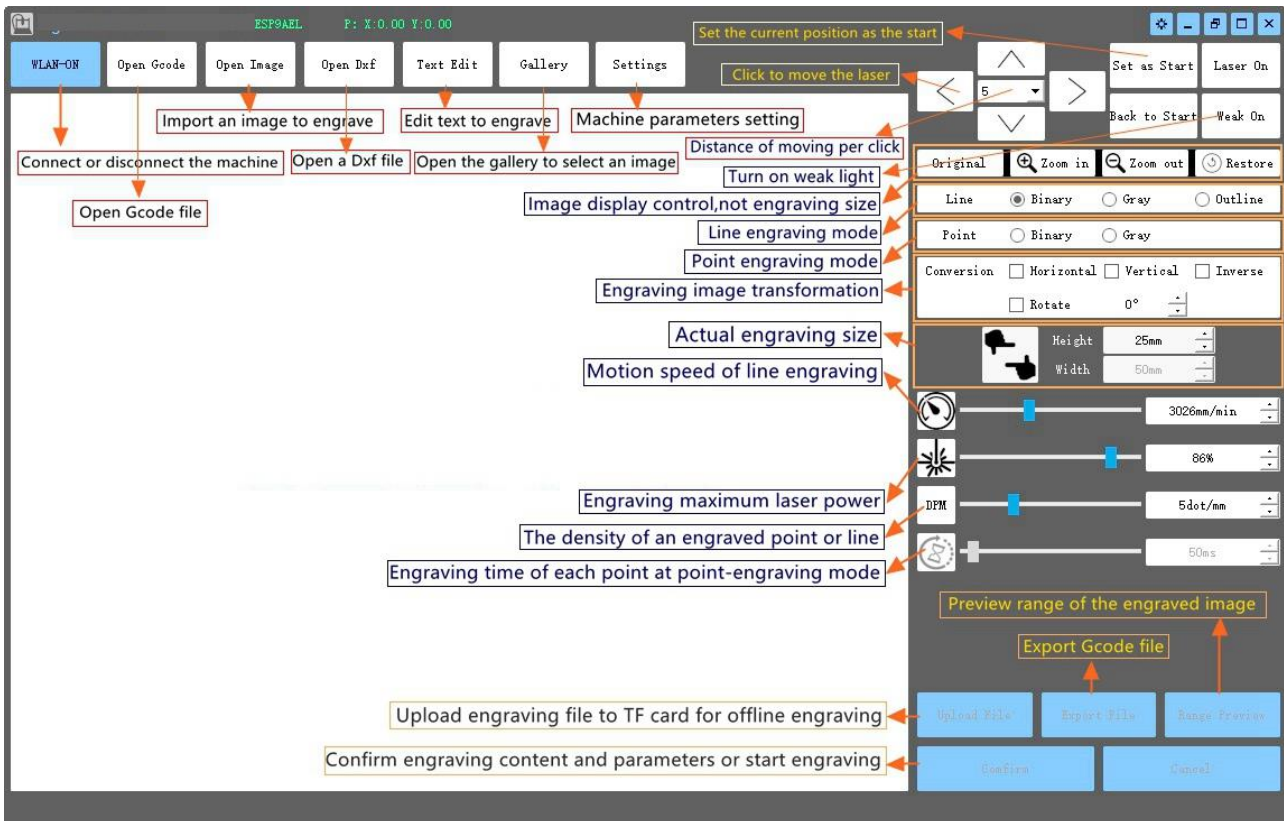

**12. Scan the QR code to download VevorWorks App**

Scan QR code or open the URL to download  
 Android or iOS App  
<http://www.vevorengraver.com/APP/download>



### 13. Control board panel

Button Mode	Function	Remarks
Power Switch Long pressed	Boot up. Press and hold the button until you hear the sound of "Di" and the status indicator starts to flash, then release the button.	
	Shut down. Press and hold the button until the status indicator goes off, then release the button.	
Power Switch Shot pressed	When the power is on, a short press will turn the weak laser light on or off, so that you can adjust the focus when you are carving offline.	
BUTTON-A Pressed	If system is idle, <b>start</b> the default file range preview in SD card.	
	If the range preview for SD file is in progress, <b>stop</b> the preview immediately.	
BUTTON-A Pressed for 1 second	<b>Restart</b> the control board (Equivalent to turning off and turning on the power), users may reconnect in WLAN connection mode.	
BUTTON-B Pressed	If system is idle or in range preview for SD file, <b>start</b> SD file engraving immediately.	
	If SD file is engraving, <b>suspend</b> engraving.	
	If SD file engraving paused, <b>continue</b> engraving.	
BUTTON-B Pressed for 1 second	If SD file is engraving or paused, <b>stop</b> engraving.	
	If system is not working and gets error (LED: Long On and Short Off), <b>clear</b> error and set control board to normal.	

Pressed for 1 second means to press and hold the button, the indicator light will be on, and wait for one second, then the light will be off or return to other flashing state and then release the button.

#### Status Indicator

Light Status	System Status	Remarks
Double Flash	Hotspot Wireless VIGO-ESPXXXX is on. System is idle and ready to work.	Normal
Single Flash	Local WLAN is connected. System is idle and ready to work.	Normal
Fast Double Flash	System is working with Vigo Works connected. (SERIAL or WLAN ON)	Normal
Fast Triple Flash	System is working with SD card file on.	Normal
Fast Single Flash	Uploading file to SD card.	Normal
Double and Double	Firmware upgrade is ongoing by OTA.	Normal
Long On and Short Off	System alarm or abnormal working. Long press button B for clear alarm or Restart.	Normal again after restart
Long On	Any button is being pressed.	Normal
Always Off	LED failure or control board failure.	Failure

Please note that if system is working or uploading, any other operations on the control board will ignore. That is if system is working on SD file, any operations by Vigo Works will have no effect. Moreover, when system is working with Vigo Works connection, any button press will ignore except Restart.

Please focus the laser on the materials referring to the laser instructions below before starting engraving.

#### 13.1 Instructions for Lase

##### Please wear the protective glasses before operating the laser!

When all the connections are completed, turn on the power, and the laser is standby for working. The indicator light on the top of the laser is continuous lighting at this time.

##### Turn on the weak light and adjust the focal length

Please lay the materials to be carved flat under the laser.

Use the focal length measuring piece to adjust the module height so that the distance from the lower edge of the module protective cover to the engraved object is equal to the height of the measuring piece. Or turn on the weak light in the engraving software or press the weak light switch on the top of the laser module. Then the red light will flash and the weak light on. Laser spots can be seen on the materials at this time. Adjust the height of the module, when the laser spots are smallest and clearest, it is the optimum state for laser engraving. After that, press the weak light switch again, and the weak light is turned off. The red light on the top of the laser is continuous lighting at this time, and the laser is standby for working.

It is important to understand that this weak light switch on the top of the laser module is not controlled by engraving control software. So be sure to switch back to normal (make sure that weak light is off) before you start engraving.

## 14. Notice and FAQ

(1) The shape of all parts above in this description is only as a sign. There may be a difference between the actual parts and the parts in the installation instructions. Please refer to the shape of the actual parts purchased.

(2) Please pay attention to the sequence of the installation steps to avoid repeated disassembly.

(3) Make sure hibernate and sleep are disabled when working long hours. This feature may cause the laser to continue to glow out of control, and burning on the table.

(4) It is strictly prohibited to use this machine unattended.

(5) Make sure to wear protective glasses before operating the laser.

### FAQ

The control software cannot be opened	Please check whether the system is Win7 or above.
Wrong control responding	Please power off the device and shut down the software, then restart both. If useless, please try below. Please restore the device by click <b>Restore</b> in setting, then click <b>Model Select</b> and choose the device you used to reset parameters.
The carving is not good or there is no burned trace	Please check whether the focal length of laser is in the recommended distance. Please check whether the laser focus is at a minimum. Please check whether the object to be caved is laid flat. Please check whether the laser is in weak light mode. Please check whether the power indicator light on the control panel is continuous lighting. Please check whether the motors are working properly.
The stepper motors are not working properly	Please check whether the connection between the three motors and control board is correct. Please check for any irrelevant stuff on the slide to block movement. Please check whether the motor drive current is normal. Too little current causes the motors to stall. Too much current makes the motors to vibrate, and causes the movement of the machine or materials to be carved. Please check whether the power indicator light on the control panel is continuous lighting.

## 15. Update

Our software will be updated continuously.

Please visit our website: [www.vevorengraver.com](http://www.vevorengraver.com) for more new products and software.

Please be sure to download the VevorWorks for this machine.

[www.vevor.com](http://www.vevor.com)

Contact: [service@vevor.com](mailto:service@vevor.com)

Call us:

**(+626) 275-4507** (For USA)

**(+44) 1173182739** (For Europe)

**(+001) 626 275-4507** (For Other Countries)

Working Time: Mon-Fri 8:00am to 5:00pm

**Powered by VEVOR 2022**