

# **VEVOR<sup>®</sup>**

**TOUGH TOOLS, HALF PRICE**

Technical Support and E-Warranty Certificate [www.vevor.com/support](http://www.vevor.com/support)

## **MANUAL TRAILER MOVER USER MANUAL**

**MODEL:QYC600**

We continue to be committed to provide you tools with competitive price.

"Save Half", "Half Price" or any other similar expressions used by us only represents an estimate of savings you might benefit from buying certain tools with us compared to the major top brands and does not necessarily mean to cover all categories of tools offered by us. You are kindly reminded to verify carefully when you are placing an order with us if you are actually saving half in comparison with the top major brands.



# VEVOR®

TOUGH TOOLS, HALF PRICE

MANUAL TRAILER  
MOVER

MODEL:QYC600



## NEED HELP? CONTACT US!

Have product questions? Need technical support? Please feel free to contact us:

 [CustomerService@vevor.com](mailto:CustomerService@vevor.com)

This is the original instruction, please read all manual instructions carefully before operating. VEVOR reserves a clear interpretation of our user manual. The appearance of the product shall be subject to the product you received. Please forgive us that we won't inform you again if there are any technology or software updates on our product.

## SAFETY INSTRUCTIONS



**WARNING:** Read and understand all instructions. Failure to follow all instructions listed below may result in serious injury.

1. Check whether the tire has enough gas before use. If the tire gas is not enough, please inflate the tire before use.
2. Check whether the screw part is loose, if yes, please tighten it.
3. Do not overload. The maximum load is 420lbs.



**CAUTION:** Please read the instructions for safe operation carefully.

### Assembly Precautions

1. Assemble only according to these instructions. Improper assembly can create hazards.
2. Wear ANSI-approved safety goggles and heavy-duty work gloves during assembly.
3. Keep assembly area clean and well lit.
4. Keep bystanders out of the area during assembly.
5. Do not assemble when tired or when under the influence of alcohol, drugs or medication.
6. Weight capacity and other product capabilities apply to properly and completely assembled product only.
7. Assemble on a flat, level, hard and smooth surface capable of safely supporting a fully loaded boat trailer dolly.

### Use Precautions

TO PREVENT SERIOUS INJURY AND DEATH FROM TIPPING:

1. Do not sit, stand or climb on this item.
2. This product is not a toy. Do not allow children to play with or near this item.
3. Do not lift while loaded.

4. To prevent tipping, push/pull using supplied handle only.
5. Use as intended only.
6. Inspect before every use; do not use if parts are loose or damaged.
7. After use, please dry before storage to avoid rusting of bolts affecting use.

## **SAVE THESE INSTRUCTIONS**

### **MODEL AND PARAMETERS**





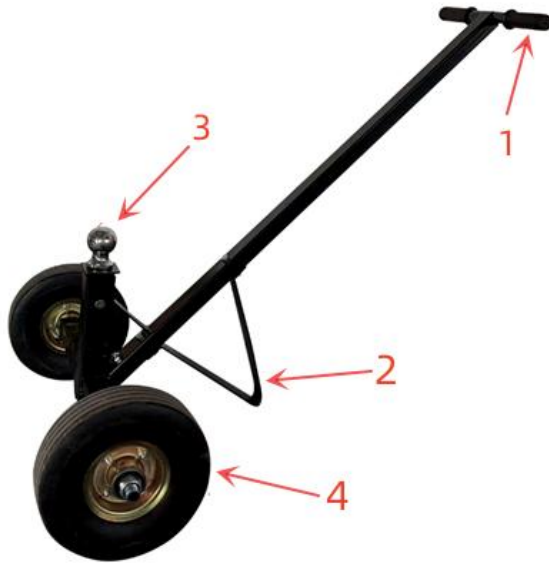





<b>Model</b>	<b>QYC600</b>
Maximum Load	600lbs
Product Size	LxWxH=113x77x71 cm
Wheel	10"(Solid Rubber Wheel)
Hitch Ball	Diameter:1-7/8"
Adjustable Height	41-61cm
Material	Steel

## STRUCTURE DIAGRAM



1.Handle 2.Supporting Plate 3.Hitch Ball 4.Solid Rubber Wheel

## COMPONENTS

 <p style="text-align: center;">① × 1</p>	 <p style="text-align: center;">② × 1</p>	 <p style="text-align: center;">③ × 1</p>
 <p style="text-align: center;">④ × 1</p>	 <p style="text-align: center;">⑤ × 2</p>	 <p style="text-align: center;">⑥ × 1</p>
 <p style="text-align: center;">⑦ × 3</p> <p style="text-align: center;">(M10)</p>	 <p style="text-align: center;">⑧ × 3</p> <p style="text-align: center;">(M10*45)</p>	 <p style="text-align: center;">⑨ × 2</p> <p style="text-align: center;">(M20)</p>
 <p style="text-align: center;">⑩ × 4</p> <p style="text-align: center;">(Φ20)</p>	 <p style="text-align: center;">⑪ × 4</p> <p style="text-align: center;">(Φ10)</p>	

## ASSEMBLY

Tools needed



Socket Wrench

**Step 1:** Connect ⑤ to ④ with ⑨+⑩

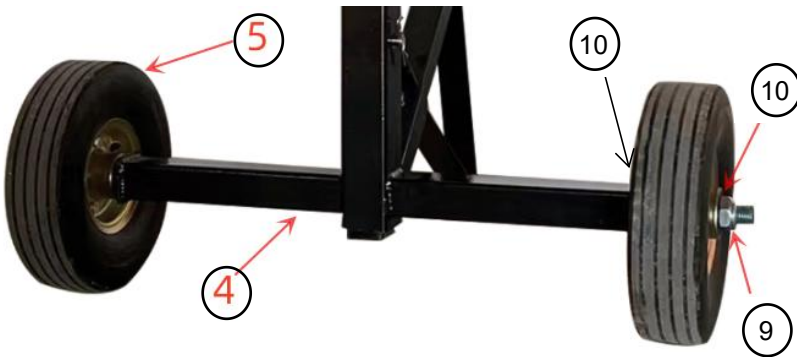



**Step 2:** Insert ② into ④ and lock with ③.

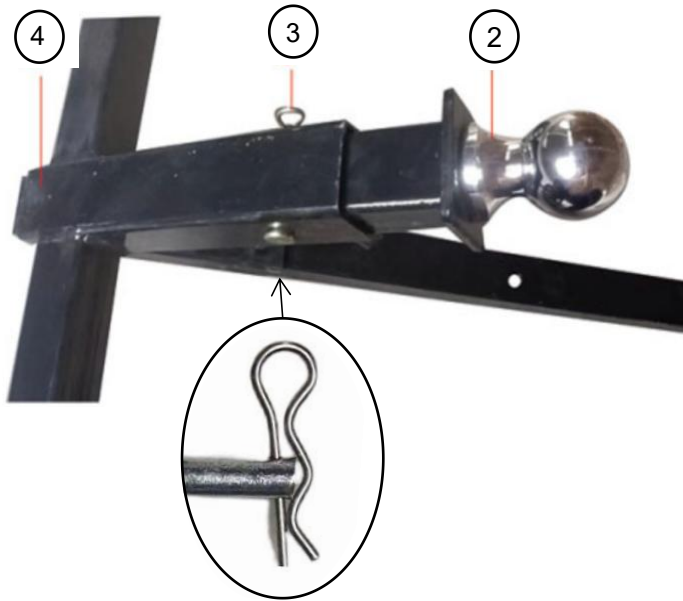

**Step 3:** Use ⑦+⑧+⑪ to connect ⑥ to ① and ④.

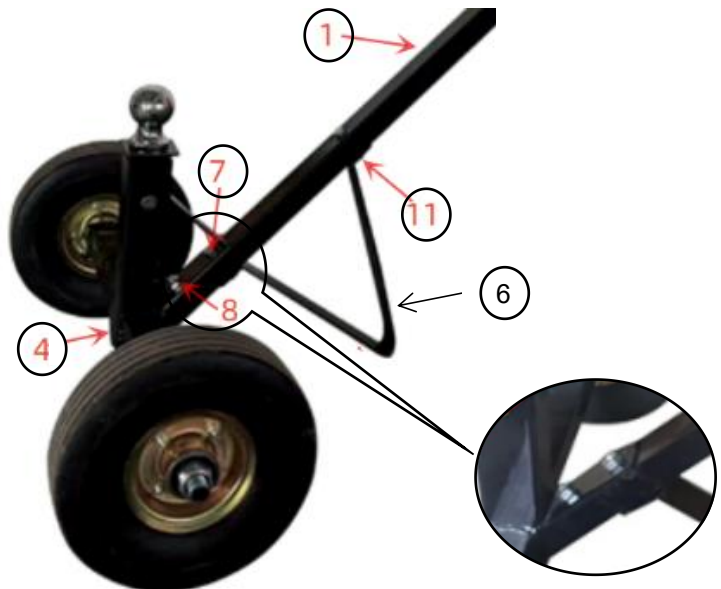

**Step 4:** Installation is complete.



## **MAINTENANCE**

- Do not overload.
- After use, please dry before storage to avoid rusting of bolts affecting use.
- Check bolts regularly for looseness.

**Importer:** WAITCHX

**Address:** 250 bis boulevard Saint-Germain 75007 Paris

**Importer:** FREE MOOD LTD

**Address:** 2 Holywell Lane, London, England, EC2A 3ET

**Manufacturer:** Wuqiang Xintianhong Tool Manufacturing Co., LTD

**Address:** Beiche Village, Wuqiang County, Hengshui City, Hebei Province

**Made In China**



EUREP UK LTD

UNIT 2264, 100 OCK STREET, ABINGDON

OXFORDSHIRE ENGLAND OX14 5DH

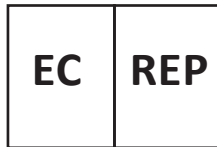

EUREP GmbH

Unterlettenweg 1a, 85051

Ingolstadt, Germany

**VEVOR<sup>®</sup>**

**TOUGH TOOLS, HALF PRICE**

**Technical Support and E-Warranty Certificate**

**[www.vevor.com/support](http://www.vevor.com/support)**