

# **VEVOR<sup>®</sup>**

## **TOUGH TOOLS, HALF PRICE**

Technical Support and E-Warranty Certificate [www.vevor.com/support](http://www.vevor.com/support)

### **AC EV CHARGER**

### **USR MANUAL**

**MODEL:EV-B06-EU003A/EV-B06-EU003B**

We continue to be committed to provide you tools with competitive price.

"Save Half", "Half Price" or any other similar expressions used by us only represents an estimate of savings you might benefit from buying certain tools with us compared to the major top brands and does not necessarily mean to cover all categories of tools offered by us. You are kindly reminded to verify carefully when you are placing an order with us if you are actually saving half in comparison with the top major brands.



# VEVOR<sup>®</sup>

TOUGH TOOLS, HALF PRICE

## AC EV CHARGER

MODEL:EV-B06-EU003A/EV-B06-EU003B



EV-B06-EU003A



EV-B06-EU003B

### NEED HELP? CONTACT US!

Have product questions? Need technical support? Please feel free to contact us:

 [CustomerService@vevor.com](mailto:CustomerService@vevor.com)

This is the original instruction, please read all manual instructions carefully before operating. VEVOR reserves a clear interpretation of our user manual. The appearance of the product shall be subject to the product you received. Please forgive us that we won't inform you again if there are any technology or software updates on our product.

Before the operation, please read the operation manual carefully to know the equipment and the correct method of use. Please keep it for future reference.

## **SAFETY PRECAUTIONS**

1. Before installation, please check the grid for single-phase 230 v  $\pm 10\%$  (50 Hz)". Otherwise unable to use it.
2. Detection of the charging device has the function of user network circuit load capacity; When the electric grid circuit of the user cannot bear the charging power of the charging device, the device will automatically reduce the charging power and then charge the electric vehicle. This function can solve the problem of frequent tripping caused by the user's grid voltage instability, circuit aging and other problems; At the same time, it can reduce the safety problems caused by the user's circuit problems. If the charging power is reduced in use, it is a normal phenomenon.
3. This equipment has over-voltage, under-voltage protection; It also has overload protection function. After the device automatically adjusts the charging power, the device will automatically shut down the charging and stop using if the user's grid voltage is still abnormal.
4. Install the equipment, the total input of the front-end must be installed circuit breakers.
5. Do not use flammable, explosive, or combustible materials, chemicals, combustible gas and other dangerous goods near the charging pile.
6. Keep dry and clean on the charging point. If there is any dirt, please use a clean, dry cloth to wipe it. It is forbidden to touch the point pin.

7. Hybrid car, please recharge again after flame out. In the process of charging, vehicle driving is prohibited.
8. Children do not get close to the process of charging so as not to cause harm.
9. In case of rain, thunder, or weather, be a cautious charge, please.
10. It is strictly prohibited that the charging cable breaks, wear and tear, charging cable nudity, charging pile has obviously been knocked down, damaged, etc. If the charging post is used, please stay away from the charging post immediately and contact the staff.
11. If there is a fire in the process of charging electric shock and other abnormal situation occurs, immediately press the stop button to ensure personal safety.
12. Please do not try to remove, maintain, or modify the charging pile. Improper use may cause damage, leakage, and so on and so forth.

## **PRODUCT INTRODUCTION**

EV-B06-EU series portable charger is designed for the pain points in the portable charging industry. It is characterized by convenient installation, use, and debugging, simple operation and maintenance, accurate measurement, and complete protection functions. It has good compatibility, and meets the charging requirements of national standard.

EV-B06-EU series portable charger has a protection level of IP66, and has good dustproof and waterproof functions, enabling safe indoor and outdoor operation.

## 1. Product Parameters

Type no.	EV-B06-EU003A	EV-B06-EU003B
In put voltage	220-240V~ 50Hz	220-240V~ 50Hz
Ou tput voltage	220-240V~ 50Hz	220-240V~ 50Hz
Power output	3.7KW	
Maximum output current	16A	
Class of protection	IP66	
Protection Function	Fire protection, over current, over voltage, under voltage, ground protection, over temperature protection, self monitoring and recovery,	
Indicator light	Standby - Green on; Charging - Yellow blinking; Alarm - red on	
Liquid crystal screen	3*LED light indicator	3*LED light indicator 1.5-inch LCD
Mode of charging	Plug and Play/APP charging	
Charging interface	European standard charging gun	
Input plug	CEE 7/7	
Material of case	PC+ABS	
Operating temperature	-30°C~45°C	
Relative humidity	5% to 95% no condensation	
Overall dimensions	245*105*63mm(H*W*D)	
Standard of reference	EN 62752	

## QUIPMENT INSTRUCTIONS

2. After the device is powered on, it enters the standby state. The device standby interface is shown below:



2.1 After inserting the charging gun head into the vehicle charging port, the charging interface is shown below:



2.2 Adjust the charging current: click the button  to adjust the charging gear:16A-13A-10A-8A-16A Cycle the current in this order.After switching the usage current, plug in the gun head to charge.

2.3 Appointment charging: Click  to increase the reservation time. You can choose between 0 and 12H. After the appointment time, it will automatically enter the charging state. All models included in this manual can be charged by APP Appointment charging.



## MOBILE PHONE APP CHARGING OPERATION INSTRUCTIONS

### 3. APP download and binding use

a. To download the smart APP, enter the following address in the mobile browser:

<https://developer.tuya.com/cn/docs/iot/tuya-smart-app-smart-life-app-advantages?id=K989rqa49rluq>

Click the website and follow the prompts to install.

b. Qr code download:



Open the mobile browser or other social software, scan the QR code, and



follow the APP according to the prompts.

### 3.1 Binding and Using Devices

Open the installed APP, click Agree privacy Statement, you can register with your mobile phone number, social software binding registration, and log in to the APP after a successful registration.

Long press A on the charging panel, and APP START appears on the display screen to enter the APP mode;





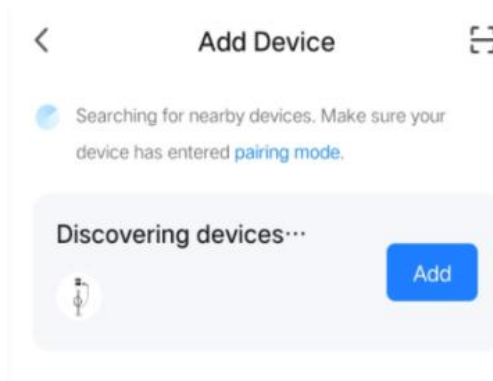





Press and hold on the charging panel again, and the display screen will display Plug and Charge to enter the Plug and Play charging mode. Open the Location, Bluetooth, and Wifi of the mobile phone. If the charging device is in standby state, the APP will automatically search for the charging device and the device name will be displayed.



c. Click Add to add the device, enter the WIFI pairing interface, automatically identify the WIFI name of the phone. Click Next, and the device will be automatically bound. After the binding is successful, a message will be displayed indicating that the device has been successfully added. Finally, click the icon of "Finish" and wait about 5 seconds for the device to be bound.

d. You can also click "+" in the upper right corner of the APP to manually add the device, select the category of "Energy saving" in the left column, pull up the device type, find the device "Car charging pile (Bluetooth + WIFI)", click to enter, and then click "Confirm indicator flashing" and "Fast flashing" as prompted. Enter the WIFI password (WIFI password connected to the mobile phone) and click Next to match the password, and always set the bound device as prompted. After binding the device, charge it according to the APP interface.

e. Device WIFI is reset:

<p><b>EV-B06-EU 003A</b></p>	<p>Press both  and  buttons on the lower panel simultaneously for 3 seconds device display panel for 3 seconds , After waiting for the display screen to display WIFI Reset, the device's WiFi will be reset.</p>	<p>Under the WiFi reset interface, simultaneously press the  and  buttons on the device panel for 2 seconds to return to the device status interface.</p>
<p><b>EV-B06-EU 003B</b></p>	<p>Press both  and  buttons on the lower panel simultaneously for 3 seconds device display panel for 3 seconds , After waiting for the display screen to display WIFI Reset, the device's WiFi will be reset.</p>	<p>Under the WiFi reset interface, simultaneously press the  and  buttons on the device panel for 2 seconds to return to the device status interface.</p>

A dark rectangular button with the text "WIFI Reset" in a light blue, monospace-style font.

Note: The APP can set charging current, reserve charging time and other functions; You can also query the real-time charging status. APP controls the charging function, which is not limited by the charging mode of the device.

## CHARGING FAULT DESCRIPTION

### 4. Charging indicator LED indicator status table.

Device Status	Three-color indicator status (green light: standby, yellow light: charging, red light: failure)
Standby mode	Green light steady on
The gun has been fired	Steady yellow light
The gun is charging	Yellow light flashing
EV-B06-EU003A EV-B06-EU003B Switch current gear status	Press the current button and the yellow light will flash once (8A ); Press the current button and the yellow light will flash twice (10A); Press the current button and the yellow light will flash 3 times (13A); Press the current button and the yellow light will flash 4 times (16A);
CP fault	The red light is on
Overpressure and underpressure	The red light flashes once per second
The PE cable is not connected	The red light flashes once in two seconds
Over-Current	The red light flashes every four seconds
Electrical leakage of equipment	The green and red lights flash once every second
Equipment overtemperature	The green and red lights flash every two seconds

#### 4.1 Fault display description(EV-B06-EU003B)

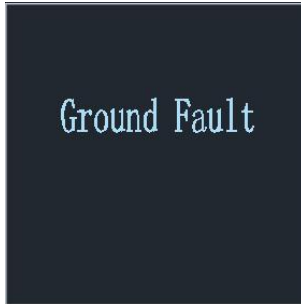

4.2 Ground Fault: The ground wire is not connected or the ground wire is poor.



4.3 CP Fault: The device detects that the CP voltage exceeds  $6V \pm 0.8$  or  $9V \pm 0.8$ , reports a CP fault, recovers the voltage to within range, and recovers the fault.



4.4 Overcurrent Fault: If the charging current of the device exceeds the threshold and continues to exceed 5s, the device will disconnect charging and report a fault, which cannot be automatically restored.



4.5 Undervoltage Fault: The rated input voltage is 230V, and a fault is reported if the voltage value is lower than  $184V \pm 5V$ .



4.6 Overvoltage Fault: The rated input voltage is 230V, and a fault is reported if the voltage value is higher than  $276V \pm 5V$ .



## INSTALLATION INSTRUCTIONS

### 5. List of Parts

General purpose accessories		
Product specification	Ac pile instruction manual	1 copy
Storage bag	Portable hard case travel bag	1 PCS
Wall mount installation		
Wall mount	Wall mounted fasteners	1 PCS
Expansion screw	M8*60 expansion screw	4 PCS
Charging cable hook	Iron hook	1 PCS

## 5.1 The installation method is wall hanging

- a. Take out the provided wall mounting fasteners and carefully check the installation dimensions of the screw holes.
  - b. Select the installation location of the device. The lowest position of the equipment is a wall mounted fastener 1200 mm above the ground.
  - c. Drill 2 holes with a diameter of 8mm according to the location of the fixed screw holes of Wall mounted fasteners, and tap in the expansion rubber plugs. Fix the mounting plate with nuts to fix the chassis.
- Dimension unit is mm.

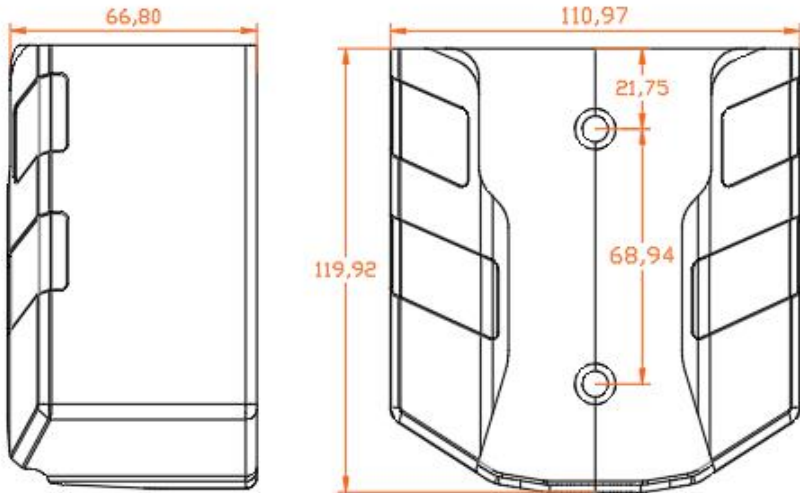

**Made In China**

**VEVOR<sup>®</sup>**

**TOUGH TOOLS, HALF PRICE**

**Technical Support and E-Warranty Certificate**

**[www.vevor.com/support](http://www.vevor.com/support)**