

Always committed to Quality, Technology & Innovation

DIGITAL READOUTS

2V/3V MULTIFUNCTION

Operation Manual

(Version V1.0)

Dear Users:

Thank you for purchasing multifunction series digital readouts. Digital readouts are used in a wide variety of application. These include machine tools, infeed axes, measuring and inspection equipment, EDM, dividing apparatuses, setting tools, and measuring stations for production control. In order to meet the requirements of these applications, many encoders can be connected to the digital readouts. Read all the instructions in the manual carefully before used and strictly follow them. Keep the manual for future references.

Safety attention:

- ⌘ To prevent electric shock or fire, moisture or directly sprayed cooling liquid must be avoid. In case of any smoke or peculiar smell from the digital readout, please unplug the power plug immediately, otherwise, fire or electric shock may be caused. In such a case, do not try to repair it, please contact the Company or distributors.
- ⌘ Digital readout is a precise measuring device used with an optical Linear Scale. When it is in use, if the connection between the Linear Scale and the digital readout is broken or damaged externally, incorrect measuring values may be resulted. Therefore, the user should be careful.
- ⌘ Do not try to repair or modify the digital readout, otherwise, failure, fault or injury may occur. In case of any abnormal condition, please contact the Company or distributor.
- ⌘ If the optical Linear Scale used with the digital readout is damaged, do not use a Linear Scale of other brand. Because the performance, specification and connection of the products of different and can not be connected without the instruction of specialized technical personnel, otherwise, trouble will be caused to the digital readout.
- ⌘ With the continuous updating of products, if there are changes or changes to the sample parameters, the random files shall prevail, and the company has the final interpretation right without notice.

Contents

1. Illustration of Panel and keyboard	4
2. Caption of the keyboard	5
3. Parameters settings	7
3.1 Parameters setup routine entrance	7
3.2 Parameters Settings Description	7
3.2.1 Setting the Resolution	7
3.2.2 Setting Positive Direction for Counter	8
3.2.3 Toggle Between R/D Display Mode	8
3.2.4 Setting Z axis Dial	8
3.2.5 Setting the Rotary Radius of the Workpiece.....	9
3.2.6 Setting the Angle Display Mode	9
3.2.7 Setting the Baudrate of RS_232(optional)	9
3.2.8 Setting the Absolute Zeroing enable or disable	10
3.2.9 Setting the Absolute form the Special Function	10
3.2.10 Setting the Calculator display Mode.....	10
3.2.11 display brightness setting	10
3.2.12 The linear scale counting frequency setting	11
3.2.13 Setting QUIT	11
3.2.14 Setting the type of the DRO.	11
3.2.15 Signal Interface Type	11
3.2.16 Restore Factory Settings:	12
3.2.17 Shrinkage Ratio enable or disable.....	12
3.2.18 Setting Compensation Type	12
3.2.19 Inch display, set the number of digits after the decimal point...	13
3.2.20 Setting EDM(optional)	13
3.2.21 Setting Linearity Compensation.	13
3.2.22 Setting the Shrinkage Ratio	13
4. General Operations	14
4.1 Zeroing.....	14
4.2 Preset Data to Designated Axis	14
4.3 Toggle Display Unit between inch and mm	14
4.4 Absolute/Incremental/200 groups SDM	15
4.5 1/2 Function	15
4.6 Clear All SDM Datum.....	16

Contents

4.7 Sleeping Mode	16
4.8 Power Interruption Memory	16
4.9 Search the Absolute Reference Point of Scale	17
4.10 Non Linear Error Compensation	20
5、200 Groups SDM coordinate	21
5.1 Zeroing at the Current Point.....	21
5.2 Preset datum of SDM coordinate	22
6、Special Function.....	24
6.1 Circumference Holes Processing	25
6.2 Linear Holes Processing	28
6.3 ARC Processing	30
6.4 Oblique Processing	39
6.5 Slope Processng.....	43
6.6 Chamber Processing.....	44
6.7 The Tool Diameter Compensation Function	45
6.8 Digital Filter of the Grinding Machine	46
6.9 Lathe Function	47
6.9.1 200 sets TOOL Libs	47
6.9.2 Taper Function	48
6.9.3 R/D Function	49
6.9.4 Y + Z Function (only applicable to : 3 axes Lathe).....	49
6.10 EDM.....	50
7、Calculator.....	56
8、Appendix	57

Illustration of Panel and keyboard

THREE AXIS PANEL

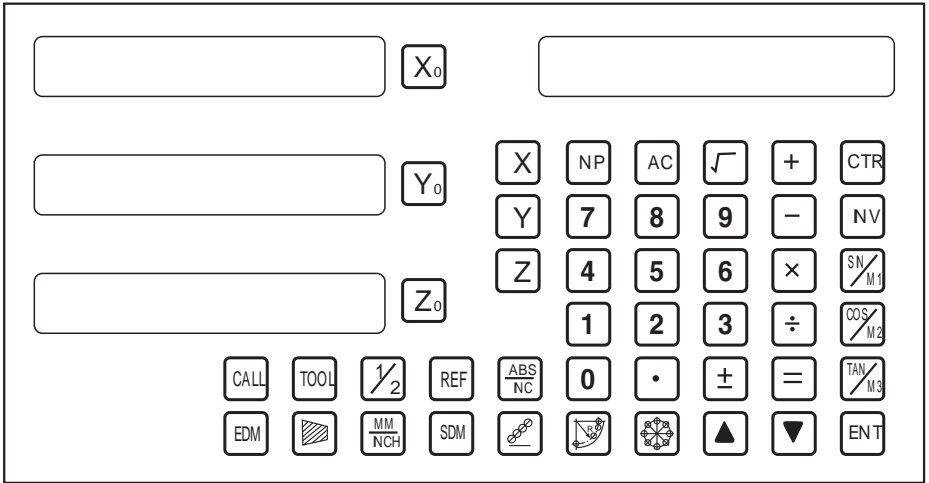



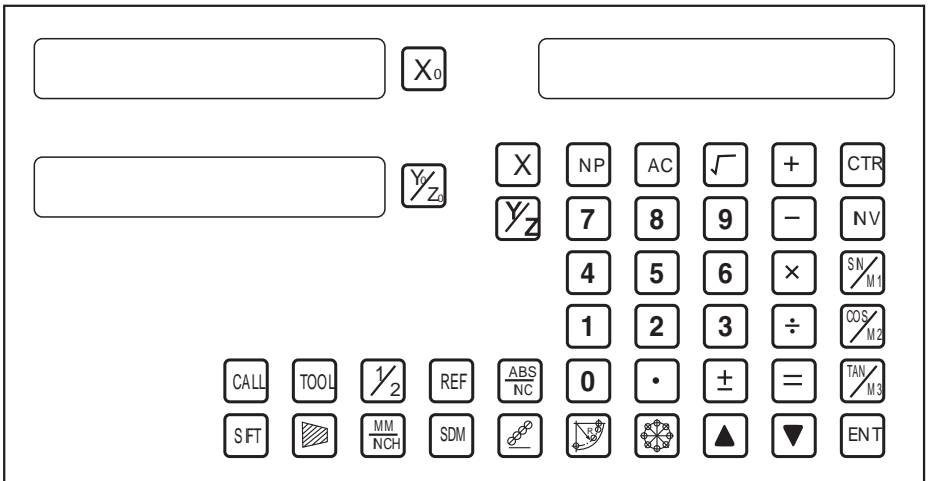































TWO AXIS PANEL















Caption of the keyboard

Keyboard Description



  	Keys for axis selection
  	Zero select axis
	Enter +/- sign
	Enter decimal point
         	Entry keys for numbers
    	Operation key (in Calculation function key)
	Enter or quit calculating state
	Cancel incorrect operation
	Calculate inverse trigonometric
	Square root
	Confirm operation
	Toggles between inch and millimeter units.
	Press when ready to identify a reference mark.
	Function keys for 200 sub datum
	ARC cutting function
	holes displayed equally on a circle
	holes displayed equally on a line





Caption of the keyboard

	Calculate trigonometric or Slope Processing function key
	Calculate trigonometric or rectangular inner chamber processing function key
	Calculate trigonometric or the tool diameter compensation function key
	Toggle between ABS/INC coordinate
	Stroll up or down to select
	Taper measured function key
	Tool library call key
	Opens the tool table.(lathe)
	EDM function key
	Filter display function key
	Half a display value of an axis
	Non Linear Error Compensation function keys

3、Parameters settings



3.1 Parameters setup routine entrance.

Press  to enter initial system and self-check after DRO powers on in 1 second, then Parameters settings display in the Parameters window.press   to select the item you want to change.

If you want to quit initial setting, press   until “QUIT” appears in message window and press . You can also press  to quit initial setting.



3.2 Parameters Settings Description

3.2.1 Setting the Resolution

Press   until “RESOLUTE” appears in message window; When selecting the LINEAR encode, the resolution will be set as follow:

There are 19 types of resolution:

0.01um;0.02um;0.05um;0.10um;0.20um;0.25um;0.50um;1.00um; 2.00um;2.50um;5.00um;10.00um;20.00um;25.00um;50.00um; 100.00um;200.00um;250.00um;500.00um.

Press  to change the resolution for X axis;Press  to change the resolution for Y axis;Press  to change the resolution for Z axis;

Set the resolution 5.00um to 1.00um for X axis:

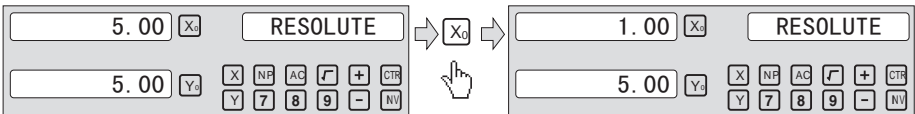

When selecting the rotary encode, the resolution will be set as follow:

Input the rotary encode parameter value .

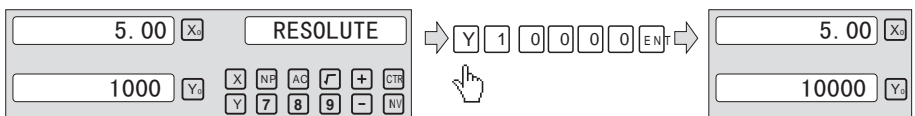

3.2.2 Setting Positive Direction for Counter

Press **▲** **▼** until “DIRECTE” appears in message window.

Direction ‘0’ means the display value will increase when scale moves from right to left and decrease when scale moves from left to right. Direction ‘1’ means the display value will increase when scale moves from left to right and decrease when scale moves from right to left.

Press **X₀** to change the Direction for X axis; Press **Y₀** to change the Direction for Y axis; Press **Z₀** to change the Direction for Z axis; as follow:

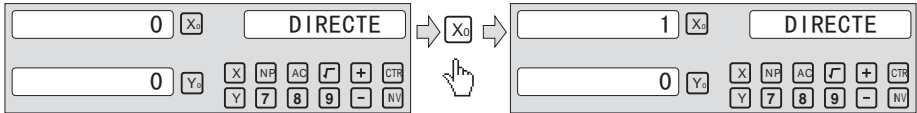

3.2.3 Toggle Between R/D Display Mode

Press **▲** **▼** until “R OR D” appears in message window. X window, Ywindow, Z window displays ‘0’ or ‘1’ separately.

‘0’ is mode R, which means the display value equals the actual measurement. ‘1’ is mode D where the display value equals the double actual measurement. Press **X₀** to change the R/D for X axis; Press **Y₀** to change the R/D for Y axis; Press **Z₀** to change the R/D for Z axis; as follow:

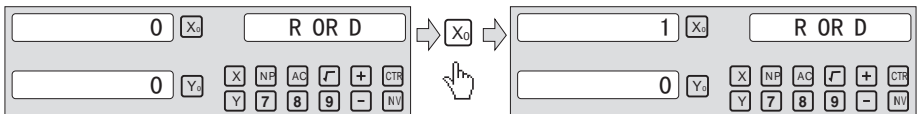

3.2.4 Setting Z axis Dial

Press **▲** **▼** until “Z DIAL” appears in message window.

Z axis dial should be set if Z axis is emulated for 2 axis milling and only install linear scale for X,Y axis. Z axis dial means the distance the Z axis travels when screw runs a revolution.

Parameters settings

Set the Z axis Dial 2.5mm as follow ;

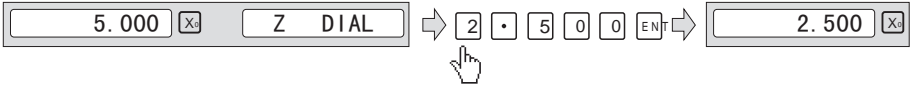

3.2.5 Setting the Rotary Radius of the Workpiece

Press until “RDIUS” appears in message window.

The Rotary rdius type is used perimeter to measure angle.

Input the Rotary Radius parameter value 2000mm as follow:

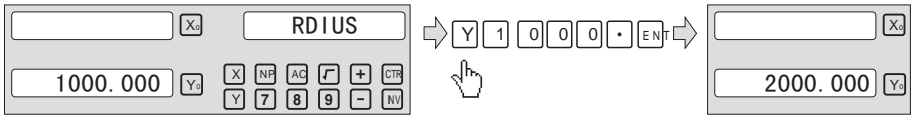

3.2.6 Setting the Angle Display Mode

Press until “ANG DISP” appears in message window.

Press to change the angle display mode for X axis; Press to change the angle display mode for Y axis; Press to change the angle display mode for Z axis; Example for X axis:

“0.0000” means the angle mode is Circulating DD;

“0000.0000” means the angle mode is Incremental DD;

“0.00.00” means the angle mode is Circulating DMS;

“0000.00.00” means the angle mode is Incremental DMS;

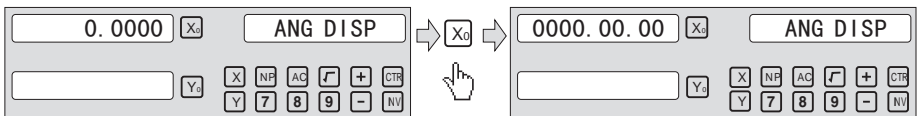

3.2.7 Setting the Baudrate of RS_232 (Special customization function, if you need to buy, please contact the dealer to customize)

Press until “BAUDRATE” appears in message window.

Set the Baudrate 115200 as follow ;

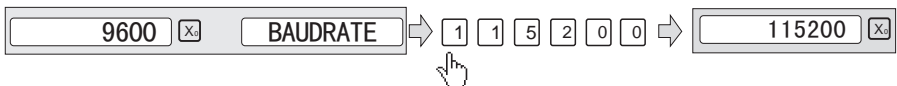

3.2.8 Setting the Absolute Zeroing enable or disable

Press until “ABS_ZERO” appears in the message window.

‘0’ means operation the ABS zeroing and preset data will be enable in the normal display state.

‘1’ means operation the ABS zeroing and preset data will be disable in the normal display state.

Press to change the absolute zeroing mode for X axis; Press to change the absolute zeroing mode for Y axis; Press to change the absolute zeroing mode for Z axis; Example for X axis:

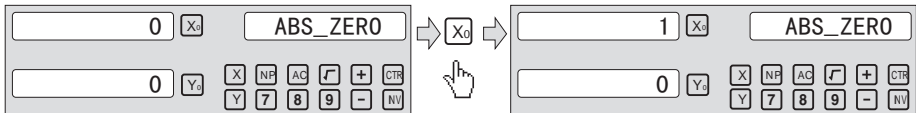

3.2.9 Setting the Absolute form the Special Function

Press until “ABS_ASST” appears in message window.

‘0’ means only special function position value is display in the Special Function operation.

‘1’ means special function position value + ABS position value is display in the Special Function operation.

Press to change the absolute mode for the Special Function will be set as follow:

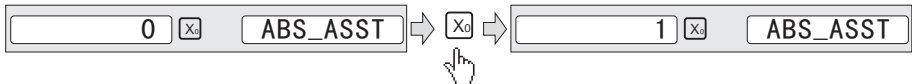

3.2.10 Setting the Calculator display Mode

Press until “CTR_MODE” appears in message window.

‘0’ means the calculator display value at the X window in the disply;

‘1’ means the calculator display value at the message window in the disply;

Press to change the calculator display mode will be set as follow:

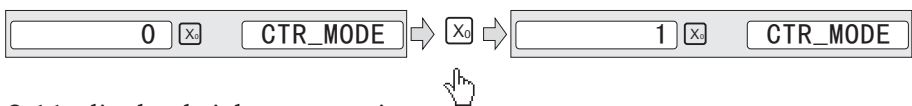

3.2.11 display brightness setting

LED display brightness setting, the factory default setting is only "3", the higher the parameter, the brighter the brightness. Press "X0" to set, it is not recommended that you set the default value yourself.

3.2.12 The linear scale counting frequency setting

The factory default setting is only "12", the higher the parameter, the lower the counting frequency, press "X0" to set, it is not recommended that you set the default value yourself.

3.2.13 Setting QUIT: Digital display table parameters quit button.

3.2.14 Setting the type of the DRO.

The type of the DRO will be display on the right window. then press the key **ENT** to select the correct type. the following system item will be set:

“MILL-3” means the DRO type is 3-axis milling machine table;

“MILL-2” means the DRO type is 2-axis milling machine table;

“LATHE-2” means the DRO type is 2-axis lathe table;

“LATHE-3” means the DRO type is 3-axis lathe table;

“GRIND” means the DRO type is Grind table;

“EDM” means the DRO type is EDM table; (Special customization function, if you need to buy, please contact the dealer to customize)

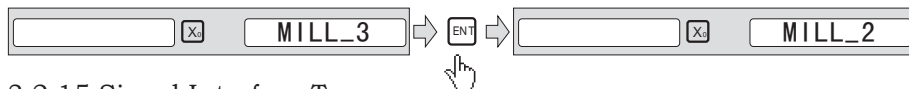

3.2.15 Signal Interface Type

Message window displays “SEL AXIS” which indicates the step is to Sensor input signal mode. Press **X0** to change the signal mode for X axis; Press **Y0** to change the signal mode for Y axis; Press **Z0** to change the signal mode for Z axis; Example for X axis:

Press **X0** to scroll through the Rotary encode type, the Linear encode type, the Rotary rdius type.

X window displays the Signal type.

“LInER” means the Signal type is linear encode type ;

“EnCoDE “ means the Signal type is Rotary encode type;

“RdIUS” means the Signal type is Rotary rdius type ;

Example: currently in the linear encode type, to toggle to the Rotary encode type;

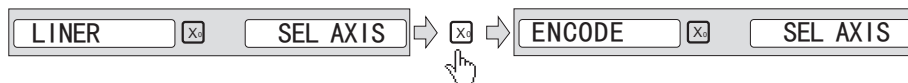

3.2.16 Restore Factory Settings:

Clear all data except DRO type.DRO will load default setup for parameter.After loading default setup,user must search RI once to enable resuming ABS dadum function;otherwise to resume the datum by RI is unable;

Message window displays “ ALL CLR” , press **[ENT]** and message windows display “PASSWORD” indicating the operator to input password; Press 2000 + **[ENT]** in turn to load default value;

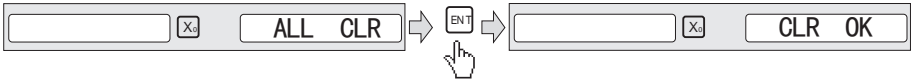

3.2.17 Shrinkage Ratio enable or disable.

Message window displays “ SRK OFF” to disable Shrinkage rate function. Press **[ENT]** to enable Shrinkage rate function in Message window displays “ SRK ON” :

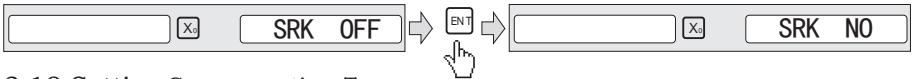

3.2.18 Setting Compensation Type

Message window displays “ SEL COMP” which indicates the step is to compensation type. Press **[X0]** to change the compensation type for X axis;Press **[Y0]** to change the compensation type for Y axis;Press **[Z0]** to change the compensation type for Z axis;Example for X axis:

Press **[X0]** to scroll through the not compensation type, the Linear compensation type, the non-linear compensation type.

“no-CO” means the compensation type is not compensation type;

“LnE-CO” means the compensation type is linear compensation type.

“non-LinE” means the compensation type is non-linear linear compensation type;

Example for X axis: currently in the not compensation type, to toggle to the linear compensation type;

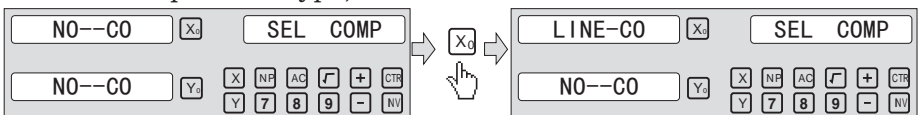

3.2.19 Inch display, set the number of digits after the decimal point

In the inch display mode, the number of digits after the decimal point is set, the factory default digit is "4", press "X0" to set, can be set according to actual needs.

3.2.20 Setting EDM: it is not recommended that you set the default value yourself, EDM function, Set the relay off on time.

3.2.21 Setting Linearity Compensation.

Message window displays “ LIN COMP” which indicates the step is to Linearity Compensation. Compensate the linear error to make display value equals to standard value.

The calculation of compensation rectifying coefficient:

$$\text{Coefficient} = \frac{(\text{Measurement} - \text{Standard value}) \times 1000.000}{\text{Standard value}}$$

Example for X axis:

Measurement 200.020mm

Standard value 200.000mm

Rectifying coefficient= (200.020-200) * 1000 /200 =-0.01mm/m

Input compensation rectifying coefficient 0.01 as follow:

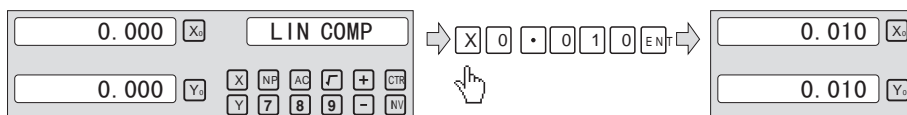

3.2.22 Setting the Shrinkage Ratio

Press ▲ ▼ until “ SHRINK” appears in message window;

$$\text{Shrinkage ratio} = \frac{\text{Dimensions of the finished product}}{\text{Dimensions of the working piece}}$$



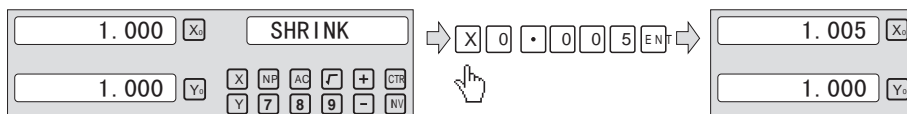





Set the shrinkage ratio 1.005 as follow;







4、 General Operations;

4.1 Zeroing

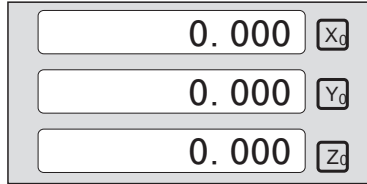
Zero the designated axis in normal display state. Zeroing is used to set the current point as datum point as follow;

- key    X axis zero
- key    Y axis zero
- key    Z axis zero



 or  or  will be return to the original data before the reset.

4.2 Preset Data to Designated Axis

Preset a value to current position for a designated axis in normal display state.

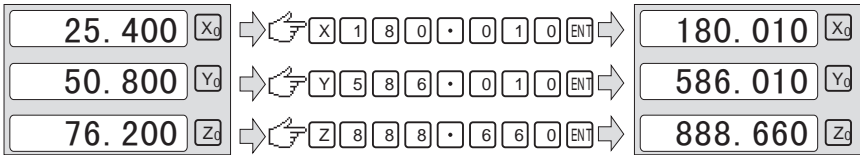

4.3 Toggle Display Unit between inch and mm

Length can be displayed either in “mm” (metric) or “inch” (imperial). Display unit can be toggled between mm and inch.

Example: Display value toggle from mm to inch;

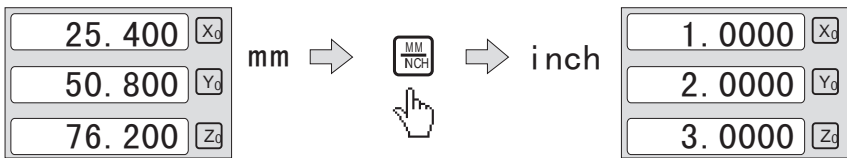

Example: Display value toggle from inch to mm;

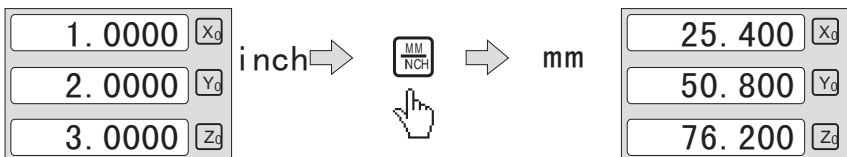

General Operations

4.4 Absolute/Incremental/200 groups SDM

Function: The DRO has 3 coordinate display modes: the absolute mode (ABS); the incremental mode (INC) and 200 groups Second Data Memory (SDM) with the range of 00 to 99. Zero point of work-piece is set at the origin point of ABS coordinate. The relative distance between datum of ABS and SDM remains unchanged when ABS datum is changed.

1. Toggle from ABS to INC coordinate;

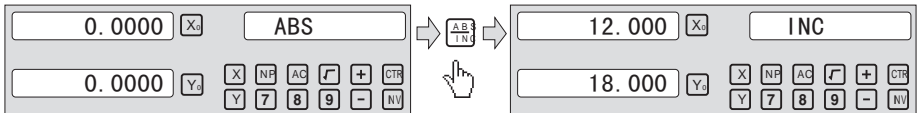

2. Toggle from INC to ABS coordinate;

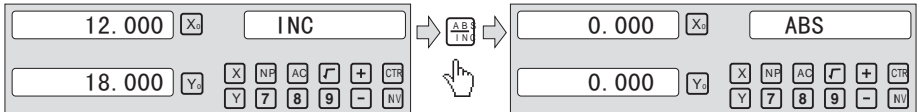

3. Toggle from SMD to ABS coordinate;

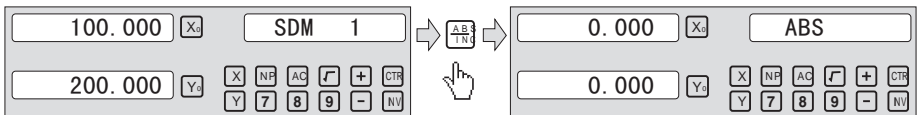

4.5 1/2 Function

Function: Set the center of work piece as datum by halving the displayed value.

Example: Set the center of rectangle as datum as the right figure.

Steps:

1、Touch one side of the workpiece with the TOOL, then zero the X axis.

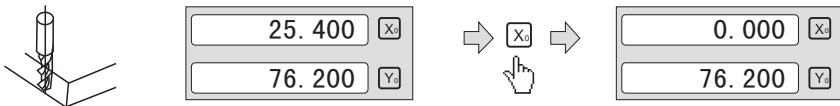

2、 Take the TOOL to the opposite side of the workpiece and touch it. Then press \boxed{X} + $\boxed{\frac{1}{2}}$ in turn to value the X axis display value.

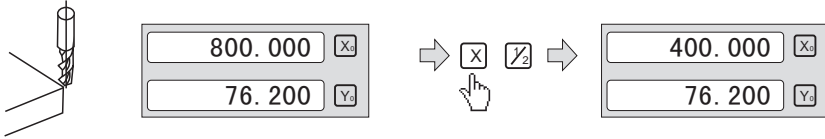

3、 Move the machining table until “0.000” is display in X axis window. The position is the work-piece’ s center.

4.6 Clear All SDM datum.

In ABS mode, to continuously press $\boxed{\bullet}$ ten times will cause to clear all the datum for 200 sets SDM. Message window displays “SDM CLR” .

4.7 Sleeping Mode

In not ABS Mode, pressing the key \boxed{REF} can turn off all the display and the DRO accessing to the Sleeping Mode, then pressing this key again will cause the DRO back to the working Mode. In the Sleeping Mode the DRO is still in working state and actually records the TOOL movement.

Example: In not ABS Mode, to access the sleeping Mode by pressing the key \boxed{REF} . In Sleeping Mode, pressing the key \boxed{REF} to quit the sleeping Mode.

4.8 Power Interruption Memory.

The memory is used to store the settings of the DRO and machine reference values when power is turn off.

4.9 Search the Absolute Reference Point of Scale

During the daily machining process, it is very common that the machining cannot be completed within one work shift, and hence the DRO have to be switched off after work, or power failure happen during the machining process which is leading to lost of the workpiece datum (workpiece zero position), the re-establishment of workpiece datum using edge finder or other method is inevitably induce higher machining in accuracy because it is not possible to re-establish the workpiece datum exactly at the previous position. To allow the recovery of workpiece datum very accurately and no need to re-establish the workpiece datum using edge finder or other methods, every Linear scale have a ref point location which is equipped with ref position to provide datum point memory function.

The working principal of the ref datum memory function are as follows.

Since the ref point of Linear scale is permanent and fixed, it will never change or disappear when the DRO system is switched off. Therefore, we simply need to store the distance between the ref point and the workpiece datum (zero position) in NON-Volatile memory. Then in case of the power failure or DRO being switched off, we can recover the workpiece datum (zero position) by presetting the display zero position as the stored distance from the ref point.

An absolute datum should be set when a work-piece is machined. There are three mode operation (REF、AB、LEF_AB):

Example: to store the X axis work datum.

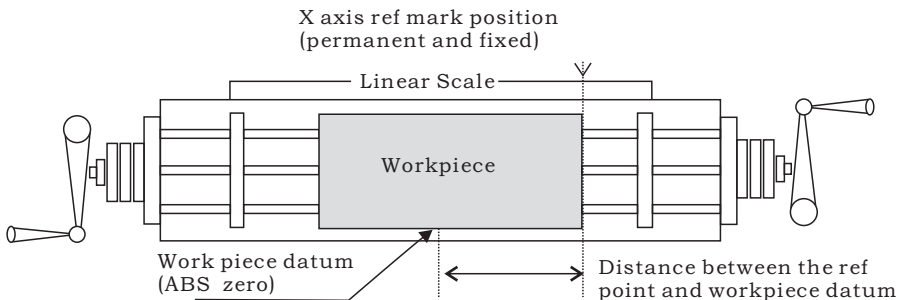

Example for REF mode :

1、DRO is set in ABS coordinate. Press **REF**, then the message window display “REF” .

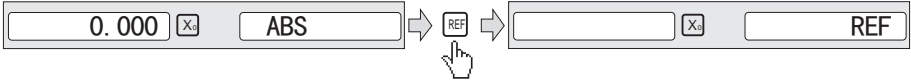

2、Message window displays “REF” , Press **ENT** until “FD_REF” appears in message window.

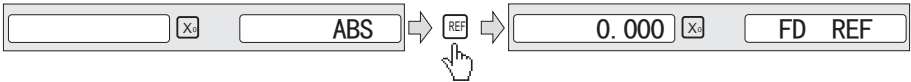

3、Select the axis which need search RI. For instance : select X axis, then press **X** . “X_REF” is displayed in message window, and X axis window flashes.

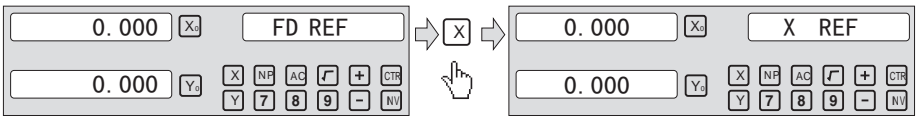

4、Move the machine table .The buzzer sounds when RI is searched, then X window stops flashing and displays the value of the current position .the DRO returns normal display state. Then message window displays “FIND_X” .

Example for AB mode :

1、DRO is set in ABS coordinate. Press **REF**, then the message window display “REF” .

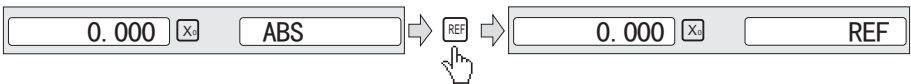

2、Press **▲ ▼**, then the message window display “AB” .

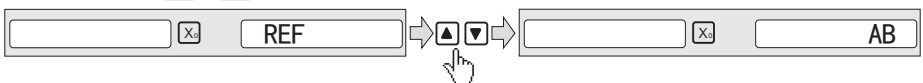

3、Message window displays “AB” , Press **ENT** until “FIND_AB” appears in message window.

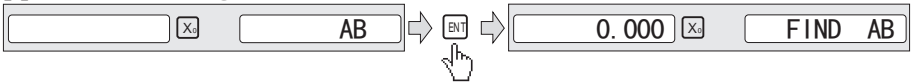

4、 Select the axis which need search RI. For instance : selcst X axis, then press **X** . “X_REF” is displayed in message window, and X axis window flashes.

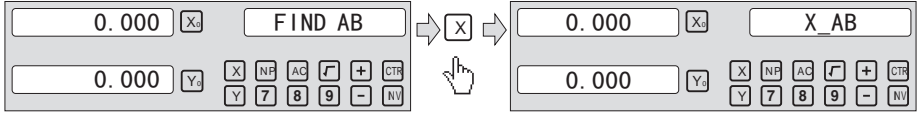

5、 Move the machine table .The buzzer sounds when RI is searched, displays the value of the current position for the absolute datum zero. the DRO returns normal display state. Then message window displays “FIND_AB” .

Example for LEF_AB mode :

1、 DRO is set in ABS coordinate. Press **REF** , then the message window display “REF” .

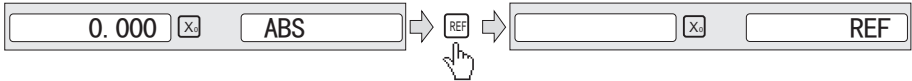

2、 Press **▲** **▼** , then the message window display “AB” .

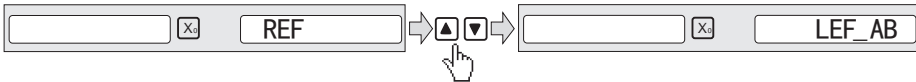

3、 Message window displays “LEF_AB” , Press **ENT** until “ZERO_AB” appears in message window.

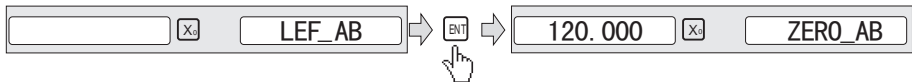

4、 Move the machine table to be set zero position piont. then press **X** , X axis will be zeroing . the current position for the absolute datum zero. the DRO returns normal display state.

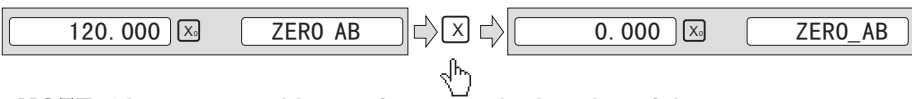

NOTE: Linear range without reference point location of the user

4.10 Non Linear Error Compensation

First compensation Type (Linear or Non-Linear) in parameter setting must be set Non-Linear. Linear scale have a ref point location and find to the Absolute Reference Point will be enable.

Default Non-Linear compensation : 50.

Example for Y axis:

Step 1: Search the Absolute Reference Point of Scale;

Step 2: Press **[NP]** , then the message window display “COMP X” .



Step 3: Press **[▲]** **[▼]**, then the message window display “COMP Y”



Step 4: Press **[ENT]**, then the message window display “NUMBER” .

Then input the compensation parameter NUMBER.



Step 5: Press **[▲]** **[▼]**, then message window displays “Y-MSN-1” which indicates the step is to Non Linear Error Compensation.

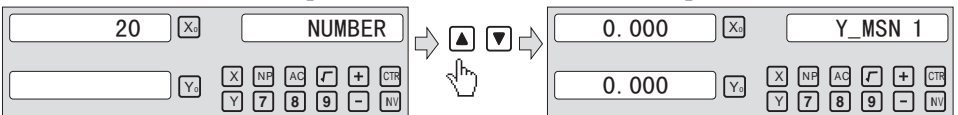

Step 6: Input compensation value .

X window display the value of the measurement value.

Y window display the value of the standard value.

Example for the first compensation point:

Measurement value :68.288mm. Standard value: 68.200mm

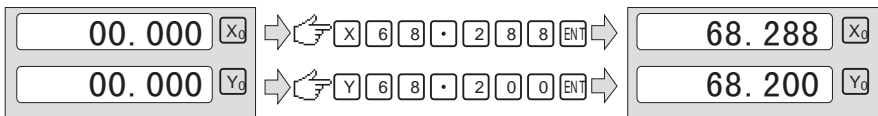

Step 7: After input all parameter, the DRO automatically exit.

5、 200 Groups SDM coordinate

The DRO has three display modes: the absolute mode (ABS), the incremental mode (INC) and the 200 groups second data memory (SDM 1 - SDM200). ABS datum of the work-piece is set at the beginning and the 200 groups SDM is set relative to ABS coordinate.

ABS Mode, INC Mode and SdM Mode are specially designed to provide much more convenience features to the operator to cope with the batch machining of relative works and the machining of the workpiece machining dimensions from more than one datum.

Example: The ABS datum is the center point O, the point sdm1, sdm2, sdm3, sdm4 needed processing are set as datum of SDM 1 - SDM 4.

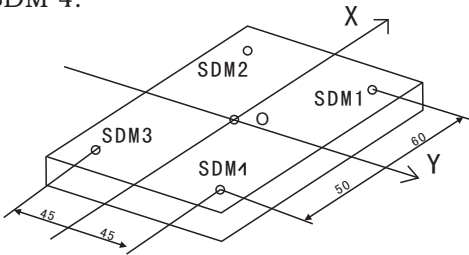

Two ways to set SDM coordinate:

- 1、 Zeroing at the Current Point.
- 2、 Preset datum of SDM coordinate.

5.1 Zeroing at the Current Point

At first set the center point of the work-piece as the origin of the ABS, then align the TOOL with point SDM1,SDM2,SDM3,SDM4 by moving the machine table and zero them. It is the position to process where the “0.000” appears in X window, Y window by moving the machine table whether in ABS or in SDM coordinate.

Steps:

- 1、 Move worktable to place the TOOL at the center of the workpiece point O as the datum of ABS. Then zero X axis and Y axis in SDM 1 ; Zero X axis and Y axis in SDM 2 ; Zero X axis and Y axis in SDM 3 ; Zero X axis and Y axis in SDM 4.

2、 Set the point sdm1 as the datum of SDM 1. Move the machine worktable to $x = 60.000$, $y = 45.000$. Then proess X_0 Y_0 .

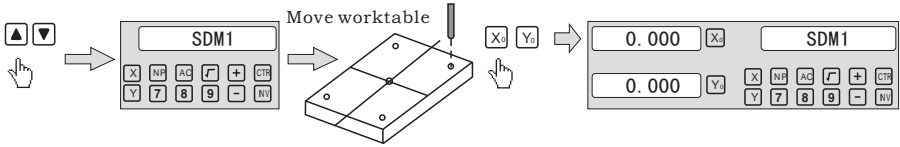

2、 Set the point sdm1 as the datum of SDM 2. Move the machine worktable to $x = 60.000$, $y = -45.000$. Then proess X_0 Y_0 .

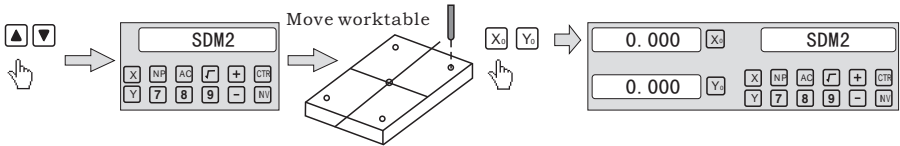

3、 Set the point sdm1 as the datum of SDM 3. Move the machine worktable to $x = -60.000$, $y = -45.000$. Then proess X_0 Y_0 .

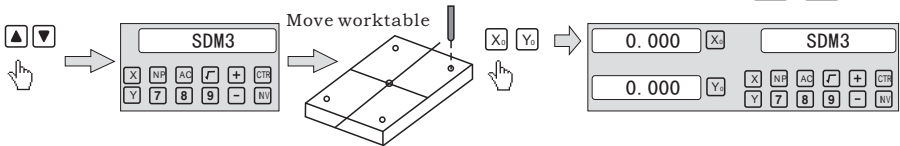

4、 Set the point sdm1 as the datum of SDM 4. Move the machine worktable to $x = -60.000$, $y = 45.000$. Then proess X_0 Y_0 .

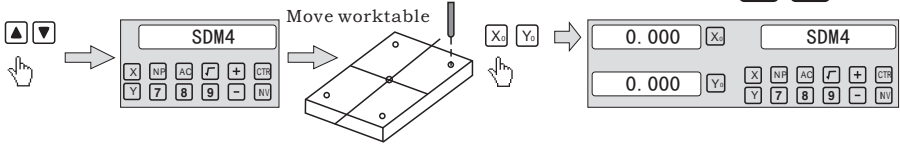



5.2 Preset datum of SDM coordinate



There are the same sample as Method 1. First Move the worktable to place the TOOL exactly at the origin of ABS, secondly Enter the ABS Mode as follow.

Steps:



- 1、 Move worktable to place the TOOL at the center of the workpiece point O as the datum of ABS. Then zero X axis and Y axis in SDM 1 ; Zero X axis and Y axis in SDM 2 ; Zero X axis and Y axis in SDM 3 ; Zero X axis and Y axis in SDM 4.

2、 Set point sdm1 as the datum of SDM 1. Press  , then the message window display “SDM 1” . Input x = 60.000, y = 45.000.





3、 Set point sdm1 as the datum of SDM 2. Press  , then the message window display “SDM 2” . Input x = -60.000, y = 45.000.



4、 Set point sdm1 as the datum of SDM 3. Press  , then the message window display “SDM 3” . Input x = -60.000, y = -45.000.



5、 Set point sdm1 as the datum of SDM 4. Press  , then the message window display “SDM 4” . Input x = -60.000, y = 45.000.



6、 Special Function

6.1 Circumference Holes Processing

The Function of PCD Hole positioning on Circumference is used to distribute arc equally, such as boring hole on flange. The right window will show the parameter to be defined when selecting PCD Function.

The Parameters to be defined are:

PCD_XY(XZ,YZ)	Select place	
CENTER	Center position	
DIA	Diameter of circle	
NO_HOLE	Hole number	
ST ANG	Starting angle	
ED ANG	Ending angle	

The position of the hole center are calculated automatically after input all parameters. Press or to choose the hole No. and move the machine table until the “0.000” appears in X window , Y window, Z window. It is the position to process a table.

Example for the XY place: Machine hole on circumference as the figure

PCD_XY(XZ,YZ)	XY
CENTER	X=0,000,Y=0.000
DIA	100,000
NO_HOLE	5
ST ANG	30,000
ED ANG	315,000

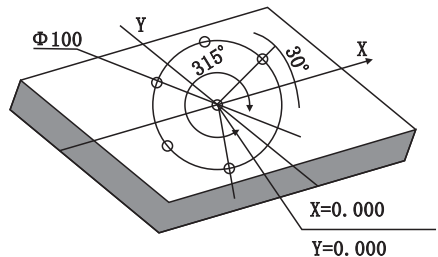

Steps:

1. Set display unit to metric in normal state; Move the machine table until the machine TOOL is aligned with the center of the circle , then zero X axis ,Y axis.

2. Select place.

Press , then the message window display “PCD_XY” to the Circumference Holes Processing. Press or to select XY place.



2. Input center position.

Press **ENT** , then the message window display “CENTER” . X and Y window displays the formerly preset center position. Input X = 0, Y = 0 as follow.

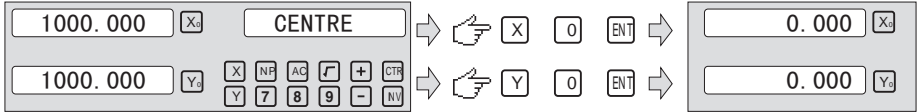

4. Input diameter.

Press **▼** until “DIA” appears in the message window. X window displays the formerly preset diameter. Then input the diameter is 100.000.

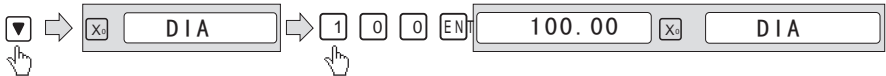

5. Input number.

Press **▼** until “NO_HOLE” appears in the message window. X window displays the formerly preset number. Then press **5** in turn to input number.

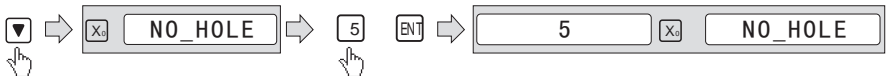

6. Input starting angle.

Press **▼** until “ST ANG” appears in the message window. X window displays the formerly preset the starting angle. Then press **3** **0** in turn to input the starting angle.



7. Input ending angle.

Press **▼** until “ED ANG” appears in the message window. X window displays the formerly preset the ending angle.. Then press **3** **1** **5** in turn to input the ending angle.

Circumference Holes Processing

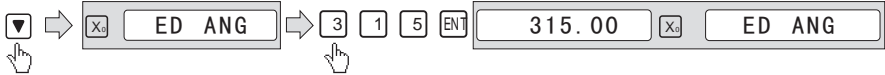

8. Press  until “NO 1” appears in the message window.

It is the position of the first hole to punch where the “0.000” is displayed in X window and Y window by moving the machine table.

After finishing the first hole, press  or  to change holes number.

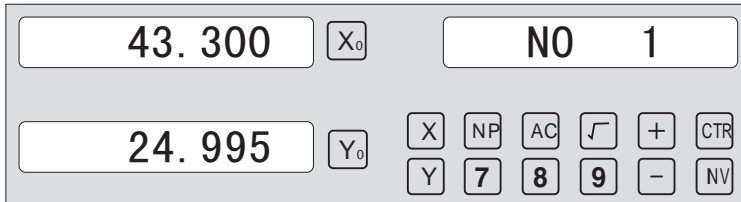

9. After processing all holes, press  to return normal display.

6.2 Linear Holes Processing

There are two modes to carry out the linear drilling: Length mode and Step mode.

- 1.LINE S Step mode
- LINE L Length mode
- 2.STEP Step length
- LENGTH Line length
- 3. ANG Angle
- 4. NO.HOLE Hole number

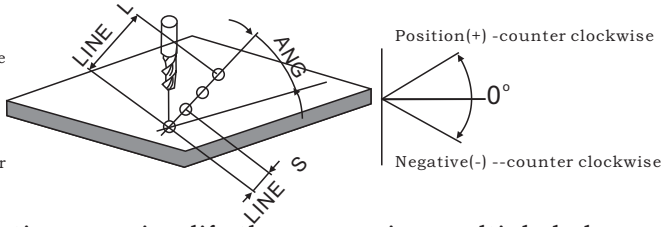

Linear Holes function can simplify the processing multiple holes whose centers are attributed equally on one line.

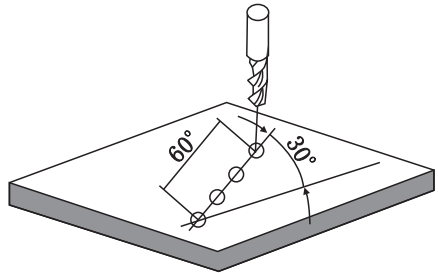

Example :

- LINE_L Length mode
- LENGTH 60.000
- ANG 30.000
- NO.HOLE 4





Steps :

1. Select piece.

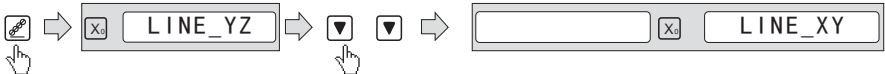
Press  , then the message window display “LINE_XY” to the Linear Holes Processing. Press  or  to select XY place.



2. Select Linear Holes mode.

Press  , then the message window display “LINE_S” . Press  or  to select “LINE_L” .

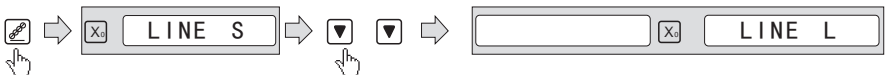

3. Input linear length;

Press  , then the message window display “LENGTH” .

X window displays the formerly preset the linear length. Press in turn to input the linear length.

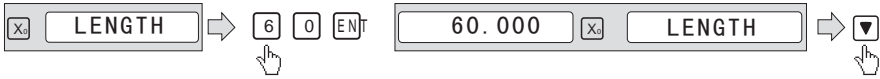

4. Input angle;

Message window displays “ANG” which indicates the step is to angle. X window displays the formerly preset the angle. Press in turn to input the angle.

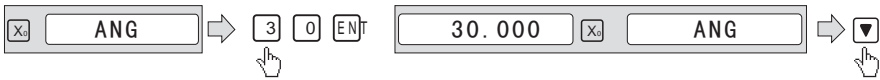

5. Input number;

Message window displays “ANG” which indicates the step is to angle. X window displays the formerly preset the number. Press in turn to input the number.

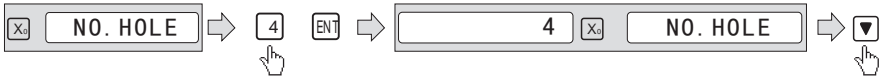

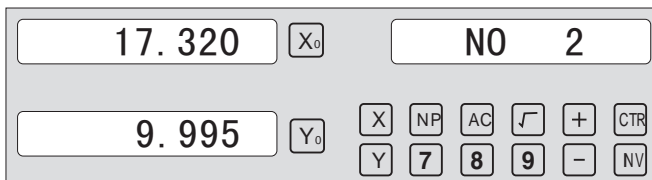

6. Press until “NO 1” appears in the message window.

It is the position of the first hole to punch where the “0.000” is displayed in X window and Y window by moving the machine table. After finishing the first hole, press or to change holes number.



7. After processing all holes, press to return normal display.

6.3 ARC Processing

Two functions are available for the ARC function: the simple ARC Function and the smooth R function. Press  to enter ARC function, then press  or  for selecting smooth ARC function or Simple ARC Function.

During installation, normally the coordinate of the machine and the direction of X, Y, Z are as per follow. The work plane is shown as the right figure.

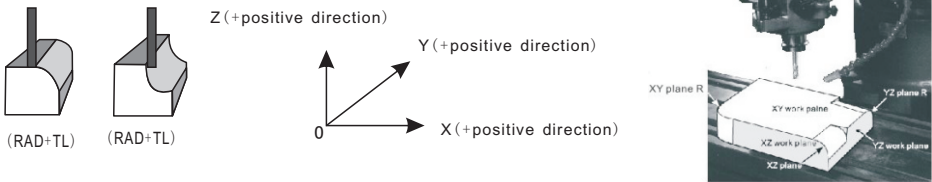

Simple ARC Function:

When the smoothness is not highly demanded, the SIMPLE ARC function is normally used for machining arc. In the SIMPLE function there are only eight type of ARC used to machine. The operator just select the type of R and input the parameters of the radius of Arc, MAX CUT and outer arc or inner arc. In general, an arc may be machined by a planar slot TOOL or arc TOOL, the different between them in different work plane as shown as per follows.

- | | |
|-----------------|-------------------------|
| 1、SIMPLE | Simple processing |
| 2、TYPE 1-8 | Mode of the ARC. |
| 3、SEL_XY(XZ,YZ) | Select place |
| 4、RAD | Arc radius |
| 5、TL DIA | Tool diameter |
| 6、MAX CUT | Feed step |
| 7、RAD_TL | Outer arc and inner arc |
| | (only for XY place) |

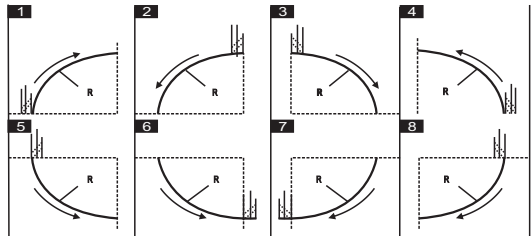

Smooth ARC function :

Provides maximum flexibility in ARC machining, the ARC sector to be machined by the coordinates of ARC. Very flexible, ARC function can machine virtually all kinds of ARC, ever the intersected ARC. Relatively a bit complicated to operate, operator need to calculate and enter the coordinates of ARC centre, start angle and end angle.

Basic parameter as follow:

- | | |
|-------------------|-------------------------------------|
| 1. SMOOTH | Mode of the Smooth ARC processing; |
| 2. SEL_XY(YZ, XZ) | Select place; |
| 3. CENTER | Refer to the position of an center. |
| 4. RAD | Radius of the ARC |
| 5. TL_DIA | Diameter of the TOOL |
| 6. MAX_CUT | Feed step |
| 7. ST_ANG | Starting angle |
| 8. ED_ANG | Ending angle |
| 9. RAD+TL | Outer arc. |
| RAD-TL | Inner arc. |

Example 1 for the Simple ARC Processing:

Parameters settings as follow:

- | | |
|---------|-------------|
| SIMPLE | Simple mode |
| TYPE | 3 |
| SEL_XY | XY |
| RAD | 80.000 |
| TL_DIA | 6.000 |
| MAX_CUT | 0.500 |
| RAD+TL | 1 |

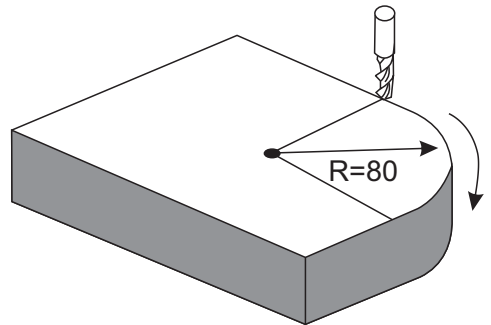

Steps:

1. Select process mode

Press  , then the message window display “SIMPLE” to the ARC Processing. Press  or  to select mode of the simple, The message window display “SIMPLE”



2. Input the type:

Press **ENT** until “TYPE” appears in the message window. X-window despalys the formerly preset the type. Press **3** in turn



3. Select place

Press **ENT** until “SEL_XY” appears in the message window.

Press **▲** or **▼** to select place to display “SEL_XY” ;

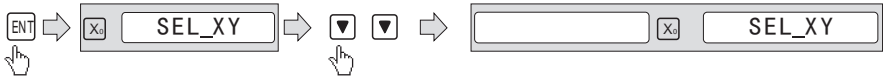

4. Input radius:

Press **ENT** until “RAD” appears in the message window. X window despalys the formerly preset the radius of ARC. Press **80** in turn to input the radius.;



5. Input Diameter of the TOOL

Press **▲** or **▼** until “TL DIA” appears in the message window. X window despalys the formerly preset the Diameter of the TOOL. Press **6** in turn to input the Diameter value;



6. Input Feed step (MAX_CUT);

Press **▲** or **▼** until “MAX_CUT” appears in the message window. X window despalys the formerly preset the MAX_CUT. Press **0.5** in turn to input the MAX_CUT value;



7. Select outer arc or inner arc

Press or until “RAD-TL” appears in the message window. Press or to select place to display “RAD+TL” ;

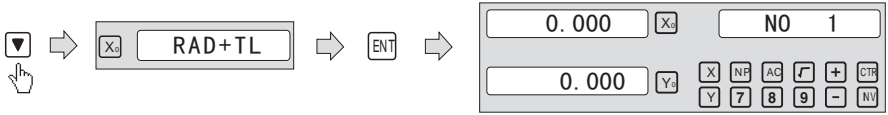

8. After inputting all parameters, press the key for machining.

The DRO will display the position of the first point. Retract the axes until the displays read 0.000, Machine the Arc point by point in accordance with the display. After finishing the position of the first point, press or to change position point.

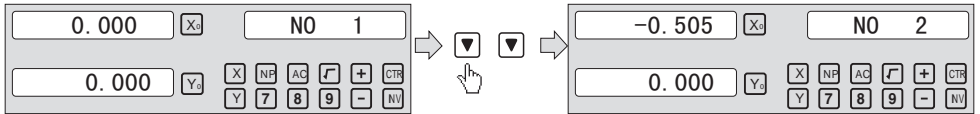

Press to quit R function any time.

Example 2 for the Simple ARC Processing:

Parameters settings as follow:

SIMPLE	Simple mode
TYPE	3
SEL_XY	XZ
RAD	80.000
TL_DIA	6.000
MAX_CUT	0.500

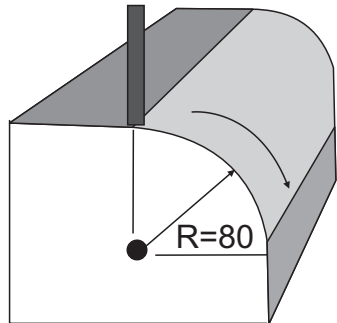

Steps:

1. Press , then the message window display “SIMPLE” to the ARC Processing. Press or to select mode of the simple, The message window display “SIMPLE”

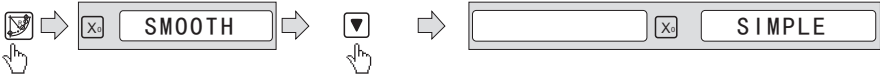

2. Input the type:

Press **ENT** until “TYPE” appears in the message window. X-window despalys the formerly preset the type. Press **3** in turn

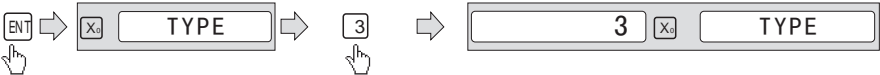

3. Select place

Press **ENT** until “SEL_XZ” appears in the message window.

Press **▲** or **▼** to select place to display “SEL_XZ” ;

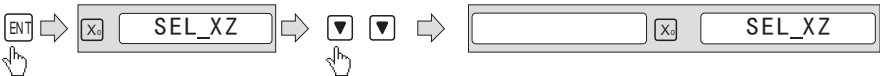

4. Input radius:

Press **ENT** until “RAD” appears in the message window. X window despalys the formerly preset the radius of ARC. Press **80** in turn to input the radius.;



5. Input Diameter of the TOOL

Press **▲** or **▼** until “TL DIA” appears in the message window. X window despalys the formerly preset the Diameter of the TOOL. Press **6** in turn to input the Diameter value;



6. Input Feed step (MAX_CUT);

Press **▲** or **▼** until “MAX_CUT” appears in the message window. X window despalys the formerly preset the MAX_CUT. Press **0.5** in turn to input the MAX_CUT value;



7. After inputting all parameters, press the key **ENT** for machining.

For 2-axis milling machine table, It is not installed with Z-axis, please press **▲** or **▼** to simulate position of Z-axis. Press **▲** simulate moving to the former process, and press **▼** simulate moving to the next process point.

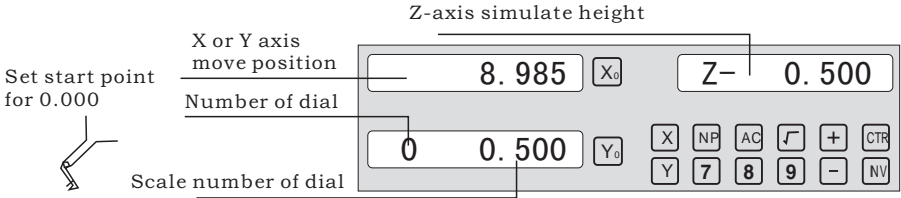

$$\text{Z-axis simulate height} = \text{Number of dial} \times \text{Z axis Dial} + \text{Scale number of dial}$$

Press **ESC** to quit R function any time.

Example 3 for the Smooth ARC function:

Parameters settings as follow:

SMOOTH	Smooth mode
SEL_XY(YZ,XZ)	XY
CENTER	X=0,Y=0
RAD	80.000
TL_DIA	6.000
MAX_CUT	0.500
ST_ANG	0.000
ED_ANG	135.000
RAD+TL	1

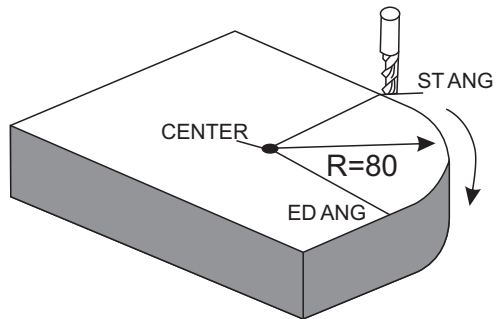

Steps:

1. Press **ESC**, then the message window display "SIMPLE" to the ARC Processing. Press **▲** or **▼** to select mode of the simple, The

message window display “SMOOTH” ; For 3-axis milling machine table without this step. In second step. Then press **ENT** .



2. Select place

Message window display “SEL_XY” which indicates the select is to place. Press **▲** or **▼** to select place to display “SEL_XY” ;

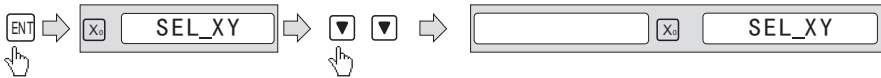

3. Input center position.

Press **ENT** , then the message window display “CENTER” . X and Y window displays the formerly preset center position. Input X = 0, Y = 0 as follow.

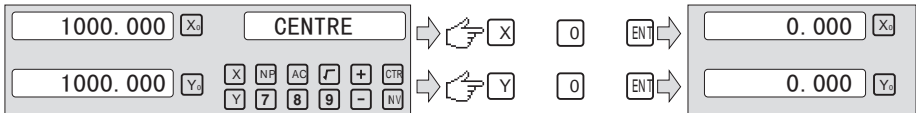

4. Input radius:

Press **ENT** until “RAD” appears in the message window. X window despalys the formerly preset the radius of ARC. Press **8** **0** in turn to input the radius.;

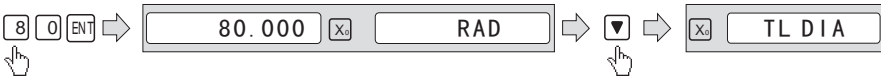





5. Input Diameter of the TOOL

Press **▲** or **▼** until “TL DIA” appears in the message window. X window despalys the formerly preset the Diameter of the TOOL. Press **6** in turn to input the Diameter value;



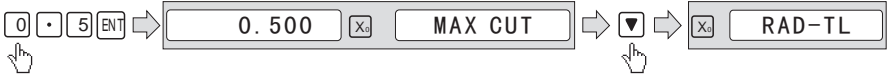

6. Input Feed step (MAX_CUT);

Press  or  until “MAX_CUT” appears in the message window. X window displays the formerly preset the MAX_CUT. Press    in turn to input the MAX_CUT value;





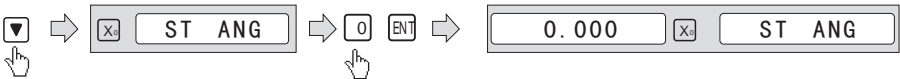

7. Input starting angle.

Press  until “ST ANG” appears in the message window. X window displays the formerly preset the starting angle. Then press  in turn to input the starting angle.





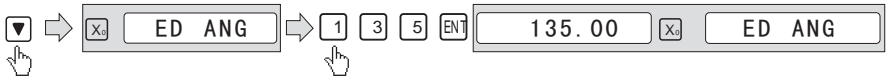

8. Input ending angle.

Press  until “ED ANG” appears in the message window. X window displays the formerly preset the ending angle.. Then press    in turn to input the ending angle.



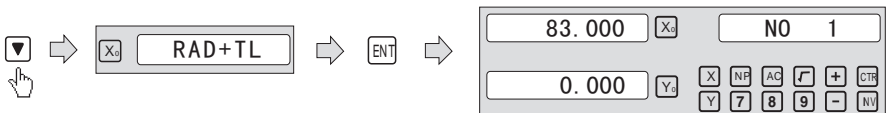

9. Select outer arc or inner arc

Press  or  until “RAD-TL” appears in the message window. Press  or  to select place to display “RAD+TL” ;



10. After inputting all parameters, machining.

The DRO will display the position of the first point. Retract the axes until the displays read 0.000, Machine the Arc point by point in accordance with the display. After finishing the position of the first point, press  or  to change position point.

ARC Processing

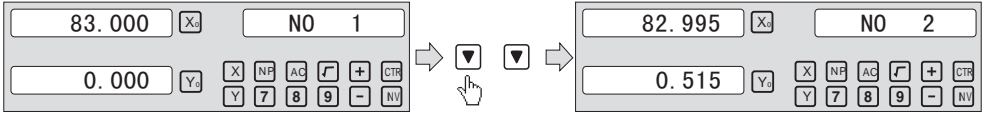

Press  to quit ARC function any time.

6.4 Oblique Processing

There are 2 ways available for machining oblique place:

a). on the place. b). on the place YZ, or XZ;

Only the following parameters need to be inputted:

INCL_XY(XZ,YZ)	Set machine place XY,YZ,Or XZ place.
ANG	The inclination angle of the oblique.
DIA	The TOOL Diameter.
ST_POT	Starting position;
ED_POT	Ending posting;

Example 1 for the Oblique XY place:

When the machining plane is on plane XY as the part shown in Figure, the angle of obliquity of the workpiece should be calibrated before the oblique plane is machined. Therefore , at this point the machining of oblique plane plays the role of calibrating the obliquity.

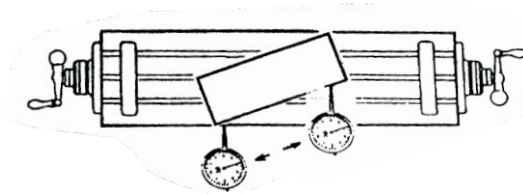

Procedure for calibrating the obliquity



First place the workpiece on the worktable as per the required angle of obliquity.

- 1) Enter the function of oblique plane.
- 2) Select the function of plane X Y .
- 3) Input the angle of obliquity.
- 4) Move the worktable until the measuring tool (such as a dial gauge) installed on the milling machine touches the obliquity-calibrating plane, adjust it to zero, and move the worktable for any distance in the direction of X-axis.
- 5) Move the worktable in the distance of Y-Axis until the display turns to zero.

6) Change the angle of the work piece to make the workpiece touch the measuring tool and adjust it to zero.

STEPS:



1. Select place

Press , then the message window display “INCL_XY” to the Oblique Processing. Press  or  to select place to display “SEL_XY”;

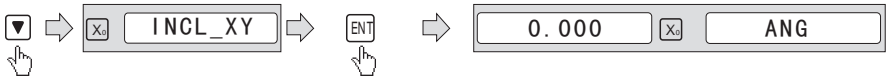
Then press  to in next step;



2. Input the angle of obliquity

The message window display “ANG” , X window dispalys the formerly preset the angle of obliquity. Press   in turn to input the angle of obliquity .



3. Move the workpiece along the X-Axis until the measuring tool touches the workpiece adjust it to zero, and move the worktable for any distance along the X-Axis.



4. Press , display the value of Y-Axis. Move the workpiece along the Y-Axis, change the angle of workpiece to make the obliquity-calibrating plane touch the measuring tool until it turns to zero. Move the worktable until Y-Axis is displayed as zero.

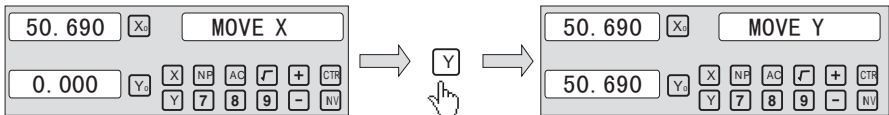

5. Press  to quit oblique function any time.

Example 2 for the oblique XZ or YZ place:

When the machining plane is on plane XZ or YZ, the function of TOOL inclination can instruct the operator to machine the oblique plane step by step.



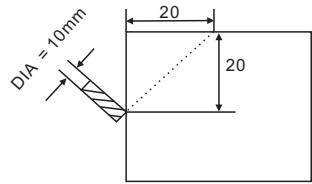
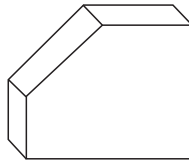

Procedures for using the function of cutter inclination:

When the machining plane is on plane XZ or YZ, first please calibrate the obliquity of the primary spindle nose and set the TOOL:

INCL_XY(XZ,YZ)	INCL_XZ
DIA	10.000
ST_POT	20.000
ED_POT	20.000



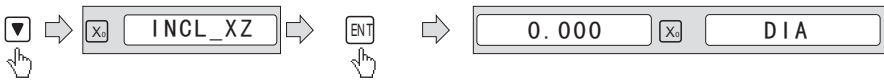

STEPS:

1. Press  , then the message window display “INCL_XY” to the oblique Processing. Press  or  to select place to display “SEL_XZ; Then press  to in next step;



2. Input The TOOL Diameter

The message window display “DIA” , X window displays the formerly preset the angle of obliquity. Press   in turn to input the TOOL Diameter of obliquity . OK, then press  to in next step;



3. Input ST_POT;

The message window display “ST_POT” , X and Y window displays the formerly preset the stating position of obliquity. Input X= 0, Y = -20.000. OK, then press  to in next step;

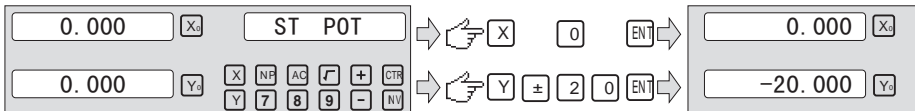

4. Input ED_POT;

The message window display “ED_POT” , X and Y window display the formerly preset the starting position of obliquity. Input X= 20.000, Y = 0.000 .

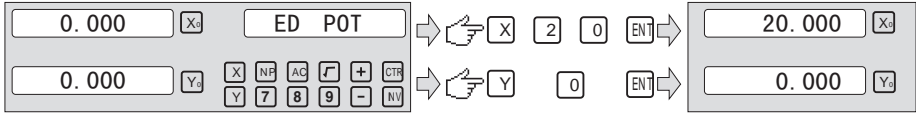

5. After input all parameter, press the key for machining.

For 2-axis milling machine table , It is not installed with Z-axis, please press or to simulate position of Z-axis. Press simulate moving to the former process, and press simulate moving to the next process point.

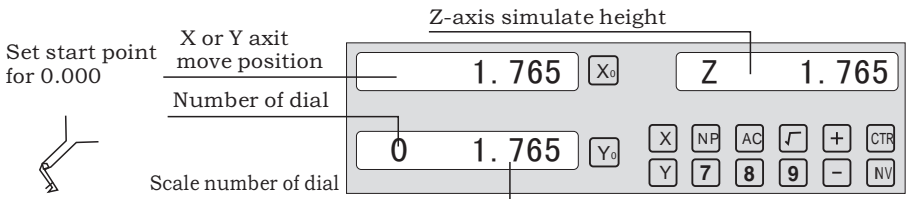

$$\text{Z-axis simulate height} = \text{Number of dial} \times \text{Z axis Dial} + \text{Scale number of dial}$$

Press to quit **oblique** function any time.

6.5 Slope Processing



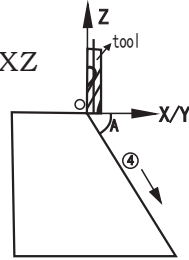

This function can calculate the position of every processing point automatically in processing slope. Only the following parameters need to be inputted:

- XZ, YZ Set machine place YZ, or XZ
- ANG The inclination angle
- Z_STEP The slope length
each time processing





Example 1 for the Slope XZ place;

Step 1. Select place

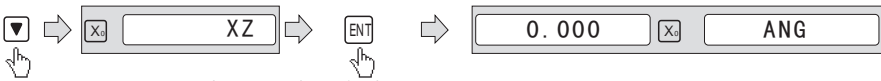
Press , then the message window display “XZ” to the slope Processing. Press  or  to select place to display “SEL_XY; Then press  to in next step;





Step 2. Input the angle of slope

The message window display “ANG” , X window displays the formerly preset the angle of slope. Press   in turn.



Step 3. Input Z_step;

The message window display “Z STEP” , X window displays the formerly preset the stating position of slope. Input    in turn.



Step 4:Finishing the ALL processing . Press  to quit slope function any time.

6.6 Chambering Processing

1,FLAT_XY: machine place; 2, DIA:diameter of TOOL; 3, CENTER: center of the chambering ; 4, SIZE: size of the chambering ; Figure as follow:

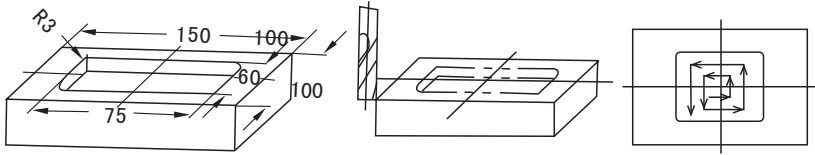

STEPS:

1. Press  , then the message window display “FLAT_XY” to the Chambering Processing.



2. Input DIA of the TOOL;





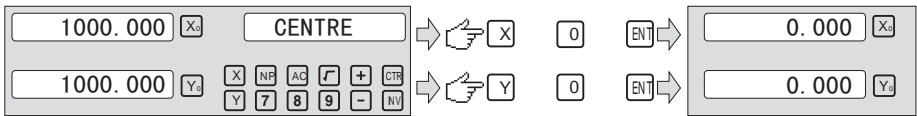

3. Input the center coordinate;

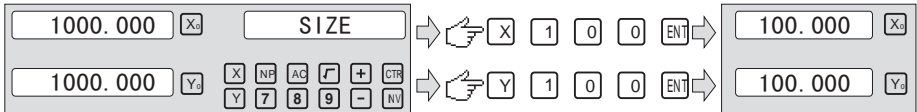

4. Input the size;



5. process Chambering;

Move the machine until the display of the axis is zero,ie, the position of the first point. Machine the first point . Display the next machining point by pressing  or  .On the completion of machining, the right window shows OVER. Press  or  , the system will goto the first position for the next workpiece. Press  to quit the Chambering Function.

6.7 The Tool Diameter Compensation Function



Without TOOL compensation, the operator has to move the TOOL for an additional distance of the diameter of the TOOL along each side when machining the four 150 and 100 sides of a workpiece to finish machining the whole brim. The digital readouts shall automatically compensate when the TOOL compensation function is enable.

Note: the TOOL compensation is made in the direction of X and Yaxis.

Procedures:

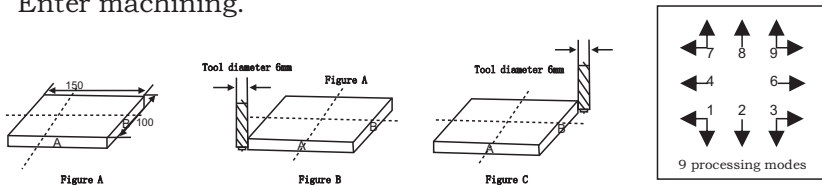
- 1) . Enter the function of compensating the diameter of the TOOL.
- 2) . Select one of the (four) preset machining modes.
- 3). Input the diameter of the TOOL.
- 4) . Enter machining.



Step1: press  to enter the TOOL compensation Function. then the message window display “TYPE” .Press .



Step 2: input the diameter of the TOOL; Press   in turn..



Step 3: Press  to the machining Mode.

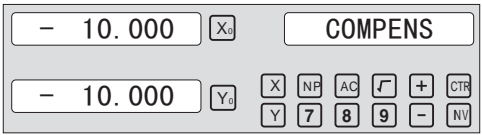

Machining of 2 side planes can be done by moving the TOOL until X-Axis is 150.000 and Y-Axis is 100.000.Press the Key  to quit the Function.

6.8 Digital Filter of the Grinding Machine

When machine a work-piece by grinder, the display values quickly due to the vibration of grinder. User can not see display value clearly. Grinder DRO provides display value filter function to disable the quake change of display value.

STEPS:

1. Enter display value filter function.

In normal display state, press **SFT** to simultaneously, enter display value filter function.

2. Exit display value filter function;

Press **SFT** , exit display value filter function;

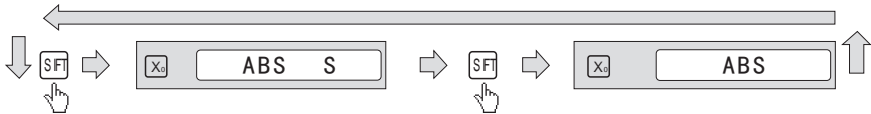

6.9 Lathe Function

6.9.1 200 sets TOOL Libs

It always needs different TOOL when processing different parts. For convenient operation, the Lathe digital readouts has the function of 200 sets TOOL Libs.

Note: Only when the lathe is equipped with the tool setting block , the 200 sets TOOL Libs can be used.

1. Set a datum TOOL. After tool setting, Zero X axis and Z axis, the set zero of absolute coordinate.
2. According to the size of TOOL1 and datumTOOL, determine the position ofTOOL relative to zero of absolute coordinate and datum tool. As Figure 6-1. The relative size of TOOL 2 is as follows X axis 25-30=-5, Z axis 20-10=10.
3. Save the TOOL number and the size into digital readout.
4. The number of TOOL can be input at random, the digital readouts will display the position of tool to absolute coordinate zero. Move lathe until X axis and Z axis both display zero.
5. TOOL Libs can save the 200 sets of the data of tools.
6. The TOOL Libs must be use in the opening state. The 200 sets TOOL Libs can be opened by continuously pressing $\boxed{\pm}$ ten times until the right window flashes TL - OPEN and a mark “ Δ ” display at the left of the right information window. The Mark indicate the operator can setup or revise the 200 sets TOOL Libs. Continuously pressing the key $\boxed{\pm}$ ten times will cause the 200 sets TOOL Libs to be closed and the right window flashes TL - CLOSE and the Mark disappear . When the Mark “ Δ ” disappear the 200 sets TOOL Libs can not be revised.

The operations for TOOL data and calling TOOL is shown as follows.

Step 1: In ABS state, input the data of the 200 sets TOOL Libs. To opening the 200 sets TOOL Libs by continuously pressing the key $\boxed{\pm}$ ten time. A Mark “ Δ ” will appear at the left window of the right info window.

Lathe Function

Step 2: Press **TOOL** to access the inputting state. Input TOOL 1 data:

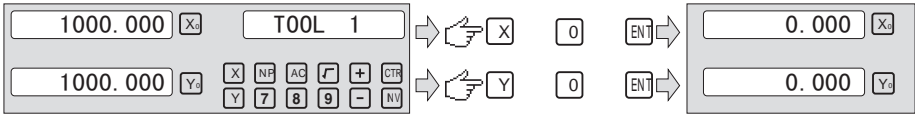

Step 3: Input TOOL 2 data:

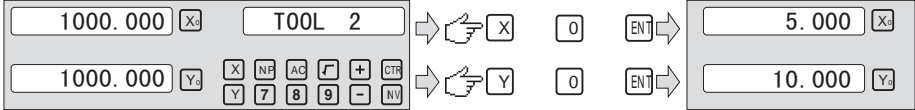

Step 4: Press to continue to input the data of next tool. By pressing number and the key **ENT**, the operator can directly input the special tool data. Press **TOOL** to quit.

After TOOL libs is setup. Use the TOOL libs according to the following operations first mount the second tool.

Step 5: To access the using state by press **CALL**. Then press **2 ENT**.



Step 6: Press **▲** or **▼**. Select the base TOOL. Then press **1 ENT**.



Step 7: Press **CALL** to quit the function;

Note:

When the base tool is used, the axis can not be zeroed in ABS state.

When the others are used, the axis can only be zeroed in INC state.

6.9.2 Taper Function

For lathing the workpiece with taper, the taper of the workpiece can be measured in processing;

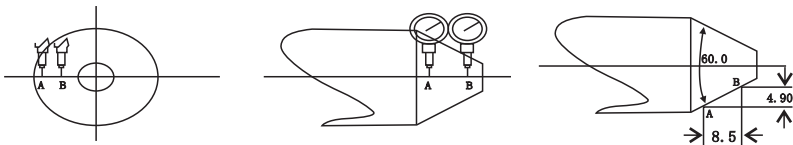

Operations :

As figure, contact surface A of workpiece with lever readouts and resets the lever readouts point to zero.

Step 1: Press , then the message window display “MEASU” to the paper processing. Move the lever readout to the surface B until the lever readouts point as follow;

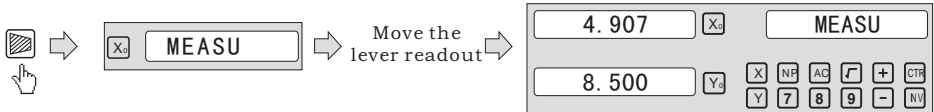

Step 2: Press  to calculate .

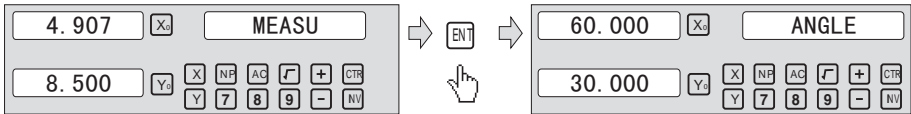

Step 3: press  to quit the function;

6.9.3 R/D Function

For 2 axes Lathe and 3 axes Lathe, press , The display Mode of X axis is switched between Radius and Diameter . When X axis for display of Diameter, A mark “ ∇ ” will appear at the left of the right information window, but when X axis for display of iameter , the mark “ ∇ ” disappear . Only X axis has the function of the diameter / radius transformation.

6.9.4 Y + Z Function (only applicable to : 3 axes Lathe)

For 3 axes Lathe, the counter of Y axis and the counter of Z axis can be added to displayed in the Z axis by pressing the key , then press the key can cancel the Y + Z function.

6.10 EDM (Special customization function, if you need to buy, please contact the dealer to customize)

1、 Description: This function is used for the special machining of Electro Discharge Machining (EDM). When the set target value of EDM Z- axis is equal to the present value, the digital readout will output the switch signal to control EDM to stop the depth machining.

The setting of Z-axis direction the Digital Readout is shown as Fig 1, i.e. The deeper the depth is, the large the coordinate value of Z-axis displays. Since starting machining, the depth will gradually deepen and Z-axis.

According to the set Z-axis direction, the machining direction is divided into positive and negative machining. When the electrode descends and the machining is carried out from up to down, the digital readout value will increase, which is called positive machining (Positive). The setting of this direction is the normal setting.

When the electrode ascends and the machining is carried out from down to up, the digital readout value will decrease. The machining direction is negative direction (negative), which is also called negative machining (shown as Fig.1)

The Digital Readout also features other functions, such as negative fire proof-height. Negative fireproof height function is a kind of intelligent position follow check safety protective device. In the process of machining, the electrode surface will generate the carbon accumulation phenomenon. Due to the long-time or diurnal machining without tending , when generating the carbon accumulation and nobody makes the cleaning, the electrode will slowly increase along the negative direction. Once the electrode exceeds the liquid level, it will frequently catch fire and cause losses. This function is just set to aim at this problem. When setting negative fireproof height, and the increased height of electrode exceeds the height between it and the depth of machined surface (i.e. Negative fireproof height), the digital readout display will blink for warning; at the same time, the output signal will automatically turn off EDM to eliminate the fire chance.

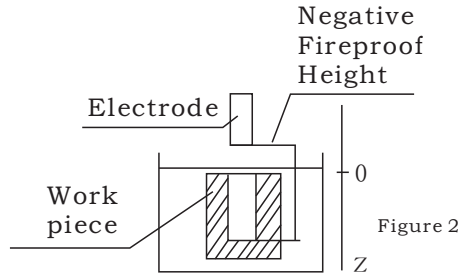
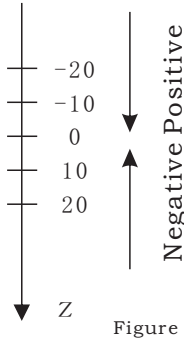

2. procedure :

See the following example for detailed machining.

- 1) Before machining, firstly set each parameter of DEPTH (machining depth);ERRHIGH(negative fireproof height), machining direction(POSITIVE / NEGATIVE) ; exit mode (AUTO/STOP) and EDM Relay Output Mode.
- 2) Move the main axis electrode of Z-axis to make it contact the workpiece reference. Clear A-axis to zero or set the value.
- 3) Enter EDM machining by press the key .
- 4) X-axis will display Machining depth target value. Y-axis will display Value has been to be depth. (The value on Y-axis is the value that the workpiece has been machined depth) Z-axis will display Self-position real time value. (The value on Z-axis is the position value of the main axis electrode of Z-axis.)
- 5) Start machining, Z-axis display value is gradually close to the target value, and Y-axis display value is also gradually close to the target value. If at this time, the electrode is repeatedly up and down, Z-axis display value will change subsequently, but Y-axis display value will not change, which will always display the machined depth value.
- 6) When Z-axis display value is equal to the set target value, the position reaching switch will be turned off, EDM will stop machining, According to the operator setting. There are two kinds of exit modes:

a) Automatic Mode:

it will automatically exit from EDM machining status and recover to the original state before machining;



b) Stop Mode:

It will always stay at the machining interface after finishing machining, and you should press  to exit and back to the original state.

Operation steps:

The DEPTH (machining Depth), ERRHIGH (Negative fireproof height), exit Mode, EDM Relay Output Mode and machining direction should be set.

STEPS:

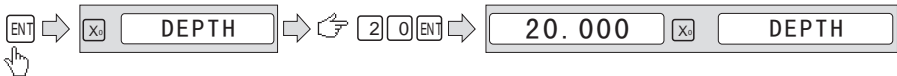

1. Press  to enter the EDM Function. Press  to input parameters; Press  to enter EDM machining state.

2. Input DEPTH (machining depth). Press the key  to set the next parameter.



3. input ERRHIGH (Negative Fireproof Height) (undefine) .Press the key  to set the next parameter.



4. Set machining direction(Positive or Negative). Press  to select Positive direction. Press  to select Negative direction. Press the key  to set the next parameter.



5. Set exit Mode (AUTO Mode or STOP Mode) Press **0** to select AUTO Mode; Press **1** to select STOP Mode ; Press the key **▲** to set the next parameter.



6. Set the Output Mode (Mode 0 or Mode 1); (undefine). Press **0** to select Mode 0; Press **1** to select Mode 1.



7. Continuously press **▼** to return EDM for machining. press **EDM** to quit the function;

Example 1: positive direction machining ;

Machining is shown as the model chamber as follows

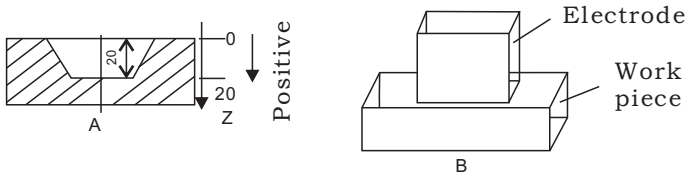

STEPS:

1、Touch one side of the workpiece with the TOOL, then press **Z0** , zero the Z axis.



2、 Press **EDM** , Setting DEPTH for 20.000; press **▼** to EDM for machining;

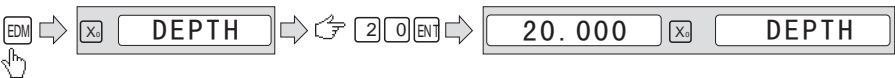

3、 Starting machining.

Machining depth target value	<input type="text" value="20.000"/>	<input type="button" value="X<sub>0</sub>"/>	<input type="button" value="EDM RUN"/>
Value has been to be depth	<input type="text" value="0.000"/>	<input type="button" value="Y<sub>0</sub>"/>	
Self-position real time value	<input type="text" value="0.000"/>	<input type="button" value="Z<sub>0</sub>"/>	

Example 2: Negative direction machining

Machining is shown as the model chamber as follows

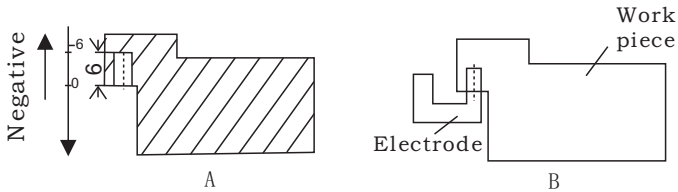

1、Touch one side of the workpiece with the TOOL, then press , zero the Z axis.

→ →

2、Press , Setting DEPTH for -20.000; press to EDM for machining;

→ → →

3、Starting machining.

Machining depth target value	<input type="text" value="20.000"/>	<input type="button" value="X<sub>0</sub>"/>	<input type="button" value="EDM RUN"/>
Value has been to be depth	<input type="text" value="0.000"/>	<input type="button" value="Y<sub>0</sub>"/>	
Self-position real time value	<input type="text" value="0.000"/>	<input type="button" value="Z<sub>0</sub>"/>	

Example 3: PCD Function for EDM



PCD Function can access the EDM Function . The operator enters PCD Function to input parameters for PCD and enter PCD machining state. At every position for machining, press the key to access the EDM Function .

When entering EDM Function, the operator can input the parameters for EDM.



The operation procedure is as follows:

1) Set PCD parameters(the setting is the same as the common setting of PCD)

After input all parameters and enter PCD machining state. The position of the first hole will be display.

2) Press  to enter EDM Function parameter(the setting methos is the same as the common setting of EDM parameter); after input all parameters , continuously press  to enter EDM machining state.

When the machining is done, press  to quit EDM function and enter PCD machining state.

3) In PCD machining state, press  for the position of the next hole, move the machine to the display value 0 , then press  to access EDM function again.

4) Repeat the step 2 and step 3 for the following machining points.

7 Calculator

The Calculator not only provides normal mathematical calculations such as +, -, x, /, it also provide trigonometric calculations such as SIN, Arc SIN, COS, Arc COS, TAN, Arc TAN SQRT etc.

The Operations are same as the commerical calculators, easy to use.

Enter and exit Calculator Function

In normal display state: Press to enter calculator function.

In calculator display state: Press to exit calculator function.

Transferring the Calculator Results fo Selected Zxis.

After calculating is finished, if the Calculator display Mode Set for mode 1, user can:

Press to transfer the calculated result to X axis; then the X window will display this value;

Press to transfer the calculated result to Y axis; then the Y window will display this value;

Press to transfer the calculated result to Z axis; then the Z window will display this value;

Transferring the Current Display Value in window to Calculator.

if the Calculator display Mode Set for mode 1, user can:

Press to transfer the display value in X window to calculator;

Press to transfer the display value in Y window to calculator;

Press to transfer the display value in Z window to calculator;

8 Appendix

1. Troubleshooting:

The following are the preliminary solvents for troubleshooting.

If there is still trouble, Please contact out company or agents for help.

Troubles	Possible reasons	Solvents
No display	<ol style="list-style-type: none"> 1. Power isn't connected 2. Power switch is off. 3. The range of power voltage is not right. 4. The inner power of Linear Scale is short. 	<ol style="list-style-type: none"> 1. Check power wire and connect the power 2. Turn on the power switch. 3. The range of voltage is in 80--260V 4. Unplug the connector of linear scale
One axis is not counting	<ol style="list-style-type: none"> 1. Replace the linear scale of the other axis. 2. DRO is in special function 	<ol style="list-style-type: none"> 1. If count is normal, the linear scale has trouble; If abnormal, the DRO readouts has trouble. 2. Quit the special function.
Linear scale is not counting	<ol style="list-style-type: none"> 1. Reading head is bad for using range exceeds. 2. Aluminum chips is in reading head of linear scale. 3. The span between the reading head and metal part of linear scale is large. 4. The metal parts of linear scale is damage. 	<ol style="list-style-type: none"> 1. Repair the linear scale 2. Repair the linear scale 3. Repair the linear scale 4. Repair the linear scale
Counting is error	<ol style="list-style-type: none"> 1. Shell is poor grounding. 2. Low precision of machine. 3. Speed of machine is too rapid. 4. Precision of linear scale is low. 5. The resolution of DRO readouts and the linear scale is not match. 6. The unit (mm/inch) is not match. 7. Setting the linear compensating is not arrest. 8. Reading head of the linear scale is damaged. 	<ol style="list-style-type: none"> 1. Shell is good grounding. 2. Repair the machine. 3. Reduce the speed of machine. 4. Mount the linear scale again. 5. Set the resolution of the DRO again, 6. Cover the unit of display mm/inch. 7. Reset the linear compensation. 8. Repair the linear scale.
The counting of the linear scale is not accurate	<ol style="list-style-type: none"> 1. The mounting of linear scale does not demand the requirement, and the prcision is not adequate. 2. The screw is loosen. 3. Precision of machine is low. 4. The resolution of digital readouts and the linear scale is not match. 	<ol style="list-style-type: none"> 1. Mount the linear scale again and level it. 2. Lock all fixing screws. 3. Repair the machine. 4. Reset the resolution of digital readouts.
Sometimes the linear scale is not counting	<ol style="list-style-type: none"> 1. The small car and steel ball is separated. 2. The glass of reading head is wearied. 3. The glass of reading head of the linear scale has dirt. 4. The elasticity of the steel wire is not adequate. 	<ol style="list-style-type: none"> 1. Repair the linear scale. 2. Repair the linear scale. 3. Repair the linear scale. 4. Repair the linear scale.

2. Specifications of Digital Readout.

- 1) Supply Voltage range: AC 85 V ~ 230 V; 50 ~ 60 Hz
- 2) Power consumption: 15VA
- 3) Operating temperature: 0°C-- 50°C
- 4) Storage temperature: - 30°C-- 70°C
- 5) Relative humidity: < 90 % (25)
- 6) Max Coordinate number: 3
- 7) Readout allowable input signal: TTL square wave
- 8) Allowable input signal frequency: < 5 M Hz
- 9) Max resolution of digital display length: 0.01 um
- 10)Max resolution of digital display angle: 0.0001 / PULSE

3. Instructions

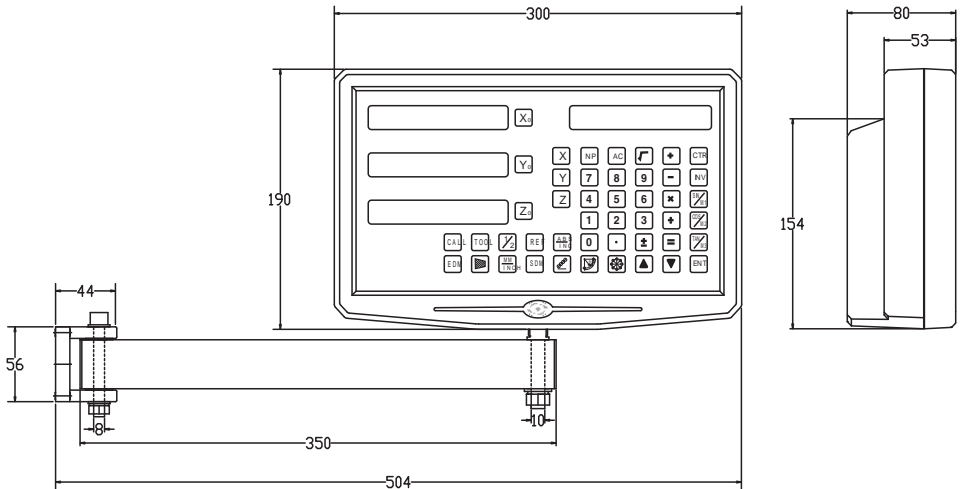

4. Examples of character output at the data interface

1、 X,Y,Z Axis

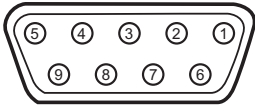

Pin	TTL (Standard)	RS-422A (Optional)
1		A-
2	OV	OV
3		B-
4		NO
5		R-
6	A+	A+
7	5V	5V
8	B+	B+
9	R+	R+

2、 RS-232

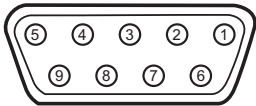

NO	external signals
1	
2	TXD
3	RXD
4	
5	GND
6	
7	
8	
9	

3、EDM

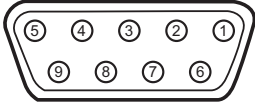

NO	external signals
1	Normally closed
2	
3	COM
4	
5	Normally open
6	
7	
8	
9	