

VEVOR[®]

TOUGH TOOLS, HALF PRICE

Technical Support and E-Warranty Certificate

www.vevor.com/support

MASSAGE CHAIR

MODEL: BH-6223

We continue to be committed to provide you tools with competitive price.

"Save Half", "Half Price" or any other similar expressions used by us only represents an estimate of savings you might benefit from buying certain tools with us compared to the major top brands and does not necessarily mean to cover all categories of tools offered by us. You are kindly reminded to verify carefully when you are placing an order with us if you are actually saving half in comparison with the top major brands.

VEVOR[®]

TOUGH TOOLS, HALF PRICE

MASSAGE CHAIR

MODEL: BH-6223

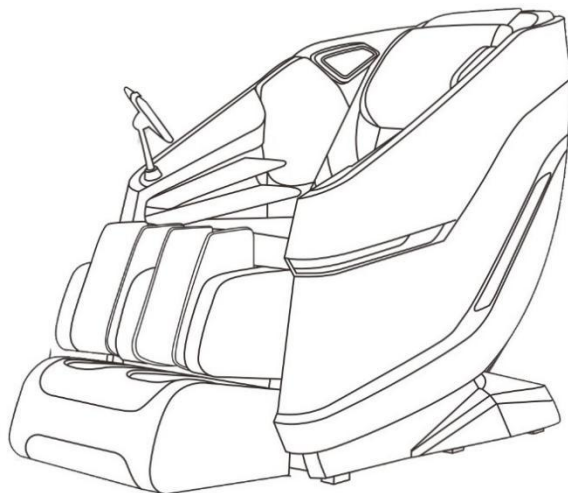

NEED HELP? CONTACT US!

Have product questions? Need technical support? Please feel free to contact us:

Technical Support and E-Warranty Certificate
www.vevor.com/support

This is the original instruction, please read all manual instructions carefully before operating. VEVOR reserves a clear interpretation of our user manual. The appearance of the product shall be subject to the product you received. Please forgive us that we won't inform you again if there are any technology or software updates on our product.









Thank you for selecting our VEVOR product. Please carefully read this operation manual before use to understand the correct use of this product and pay attention to the important safety warnings especially. Please keep this manual nearby so that you can refer to it anytime.

SAFETY & WARNINGS

Important security matters:

The following is a list of safety precautions that must be strictly observed to prevent physical and property damage during use. All safety matters will be described according to the extent of harm or damage caused by misuse.

Symbol	Meaning
 Warning	Matters which may result in serious injuries or deaths.
 Attention	Contents that may cause the minor injury or property damage.
	The sign means forbidden. Specifically, prohibited content in or near the sign with words or pictures.
	The sign means mandatory (Something that must be followed) undefined. The specific mandatory content in or near the sign with text or pictures.
	It means that the disassembly is prohibited.
	Unplug the power plug from the socket.

People who are not suitable to use this product:

If you have the following symptoms, please consult your doctor first and use them under the guidance of the doctor



Warning

- ◆ Use of cardiac pacemakers and other medical electronic instruments embedded in the body.
- ◆ Those who are being treated by doctors, especially those who feel abnormal physically.
- ◆ Patients with malignant tumor, acute disease, heart disease, severe hypertension, etc. (Normal person monitoring is required)
- ◆ Pregnant women or those who are in the menstrual period.
- ◆ Patients with osteoporosis and spinal bone fractures.
- ◆ People with skin trauma and people who need to rest quietly.
- ◆ People with a body temperature above 38 degrees Celsius (fever period).
- ◆ Product heating, the heat is not sensitive to the people must Pay attention to the use. (Normal person monitoring is required)
- ◆ People with intellectual disabilities or minors must use it under the supervision of normal people.
- ◆ People who are sensitive to heat, such as the elderly and children should use it only under direct supervision.

Controller Considerations:



Pay Attention To

- ◆ Do not operate the controller with wet hands or pull the controller wire hard.
- ◆ Do not splash water on the controller to avoid functional failure.
- ◆ Do not place heavy objects on the controller.

About the power plug and the power cord:



Pay Attention To

- ◆ Do not use a power supply other than the rated voltage to avoid causing fire or damage to the product.
- ◆ Do not plug in the power cord with a wet hand to avoid electric shock.
- ◆ When unplug the power cord, hold the plug of the power cord instead of the wire.
- ◆ The power cord should not be squeezed by the product or other heavy objects.
- ◆ Do not damage, damage, excessively bend, pull, twist or tie the power cord.
- ◆ When the power cord is damaged, do not remove and replace it without permission. Contact the dealer or qualified professional personnel to replace and repair it.

Service Environment:



Pay Attention To

- ◆ Do not use a power supply other than the rated voltage to avoid causing fire or damage to the product.
- ◆ Do not plug in the power cord with a wet hand to avoid electric shock.
- ◆ When unplug the power cord, hold the plug of the power cord instead of the wire.
- ◆ The power cord should not be squeezed by the product or other heavy objects.
- ◆ Do not damage, damage, excessively bend, pull, twist or tie the power cord.
- ◆ When the power cord is damaged, do not remove and replace it without permission. Contact the dealer or qualified professional personnel to replace and repair it. Do not use the appliance in highly humid environments such as bathrooms.

- ◆ Do not use this device in a highly humid environment such as a bathroom.
- ◆ Do not use the appliance immediately when the ambient temperature changes drastically.
- ◆ Do not use the appliance in a dusty or corrosive atmosphere.
- ◆ Do not use the appliance in confined spaces or where air circulation is poor.

Precautions for use:



Pay Attention To

- ◆ This product is only used for people weighing less than 150 kg.
- ◆ Do not use other therapeutic instruments while using this machine.
- ◆ Do not use it for therapeutic purposes.
- ◆ This product is only limited to one person, do not use two or more people at the same time.
- ◆ Do not use it immediately after meals to avoid causing discomfort.
- ◆ When using products, do not put mobile phones and other valuables in the pocket, and remove the accessories on your arms.
- ◆ Before use, please lift the back cushion to confirm whether the fabric of the backrest and other parts is damaged. If there is damage, please stop use immediately and entrust repair in time.
- ◆ During use, if the body appears or feels abnormal, please stop using it immediately and consult your doctor.
- ◆ It is recommended to use the product for 20 minutes each time.
- ◆ When adjusting the Angle of the chair back or calf, please be sure to confirm that there is no one or other obstacles behind the chair first, and ensure that there is enough space before adjusting.
- ◆ When lowering the leg or back, be sure to prevent any other excessive external forces on the leg or back, and also ensure that there are no children or animals or other items under the leg or back.
- ◆ Do not ride on the product to avoid injury or malfunction.
- ◆ Do not move casters on the wood floor and the easily damaged

ground such as carpet, or push and pull movement.



Prohibit

- ◆ If the product is damaged, broken, leakage and related parts exposed.
- ◆ No standing on the calf or squeezing other weights on it.
- ◆ Do not let children use it or play in the massage chair.
- ◆ Do not fall asleep on the product while it is working.
- ◆ Do not use this product when drunk or unwell.
- ◆ Do not insert your fingers or other objects into the product clearance to avoid injury or malfunction.
- ◆ Find any abnormal conditions (such as smoke, odor, etc.) when using them.



No disassembly

- ◆ Do not remove the internal components of the product privately to avoid the possibility of machine failure.
- ◆ Except for the company designated repair technicians, absolutely must not decompose, repair and modify the product.
- ◆ Please contact www.vevor.com/support in time.



Pull out the plug

- ◆ For maintenance, please unplug the power plug from the socket. In addition, do not plug the plug with wet hands to avoid electric shock and injury.
- ◆ Unplug the power plug from the socket.
- ◆ For a power failure, please immediately cut off the power switch and unplug the power plug from the socket.



Pay Attention To

- ◆ Do not use blankets and other cover the use of products, so as to avoid the high temperature inside the machine and accidents.
- ◆ Please make sure that the power plug and the power socket

cooperate well, and the wiring board cannot be used, so as to avoid electric shock, short circuit or fire accident.

- ◆ Do not use this product in the environment with high floating concentration of oil and gas chemicals to avoid product deformation, machine failure or fire accidents.
- ◆ Do not wipe or spray the product with organic solvent, alcohol or insecticide, so as to avoid machine cracks or electric shock, fire accidents.
- ◆ The power cord shall not be wrapped on the product to avoid electric shock, short circuit or fire accident.
- ◆ Do not use this product naked to avoid causing skin damage.
- ◆ Do not sit directly on the legs or armrest parts to avoid injury or accidents.
- ◆ Do not use this product near the fire source or the heater, and do not use it on the ground with floor heating or other heating conditions.
- ◆ Do not smoke when using, so as to avoid fire.
- ◆ When the body is wet, never use it to avoid electric shock accident or machine failure.
- ◆ Please avoid continuous massage in the same part. If you need to continue to use, please interval for more than 30 minutes to avoid overstimulating the muscle or nervous system.
- ◆ The water inside the host or falls into the debris or the product is damaged. If this situation occurs accidentally, please stop using it immediately.
- ◆ Before using the product, please confirm whether the power switch is working normally, so as to avoid accidents.



Mandatory





- ◆ Keep children away from the movable parts of the appliance.
- ◆ Use a well-grounded power supply that is compatible with the appliance.
- ◆ Unplug the appliance after use or before cleaning to avoid equipment or personal damage.

- ◆ Use the appliance as instructed in this manual.
- ◆ Do not use accessories and attachments not recommended.
- ◆ Do not use the appliance outdoors.
- ◆ Please read this manual carefully before using the appliance.
- ◆ Do not use the appliance for purposes other than those listed in this manual.
- ◆ Do not use the appliance if the cover cloth is torn or damaged.
- ◆ Do not use the appliance with a damaged case or jacket.
- ◆ Do not use the appliance with anything covering the cooling holes of the appliance.
- ◆ Do not allow any objects to fall into the appliance.
- ◆ Do not sleep while using the appliance.
- ◆ Do not use the appliance when you are intoxicated or feeling unwell.
- ◆ Do not use the appliance within one hour after eating.
- ◆ Do not use excessive force when using the appliance to avoid injury.
- ◆ Do not use "heat" massage for a long time.
- ◆ Before using the appliance, be sure to lift up the cape to check if the fabric of the backrest covering the range of motion of the massage wheels or other parts of the fabric are damaged. If damage is found please stop using it immediately, unplug it from the power supply and report the appliance for repair.
- ◆ After each use, the power switch should be pressed to the "O" (off) position, unplugged, otherwise it may be Otherwise, accidents or injuries may be caused by naughty children.
- ◆ This appliance can only be serviced by the manufacturer's designated service center, the user may not disassemble or repair the appliance by themselves.
- ◆ Please use the appliance intermittently, and should not make the appliance run continuously for a long period of time.
- ◆ Do not stab the appliance with sharp objects.
- ◆ Stop using the appliance immediately if you feel abnormal in use. Consult www.vevor.com/support before further use.

PRODUCT SPECIFICATIONS

Product Name	Massage Chair
Model No.	BH-6223
Rated Voltage	110VAC~120VAC 220VAC~240VAC
Rated Frequency	50-60Hz
Rated Power	100W
Maximum Working Time	30 mins
Product Size	Upright Condition: 1430*730*1060mm
	Zero-gravity Condition: 1750*730*880mm
Packaging Size	1130*745*1210mm (with pallet)
	1130*745*1100mm (without pallet)
Weight	Net Weight: 60kg
	Gross Weight: 84kg (with pallet)
	72.8kg (without pallet)
Wire Length	Length of Power Line: 150cm
Using Environment	Ambient Temperature: 0°C~35°C
	Relative Humidity: 20%~80%RH
Storage Environment	Ambient Temperature: -5°C~40°C
	Relative Humidity: 20%~80%RH
Safety Function	With Overheat & Over-current Protection
Maximum User Weight	150kg

PACKING LIST

 <p>massage chair(*1pc)</p>	 <p>touch panel(*1pc)</p>	 <p>touch panel bracket(*1pc)</p>
 <p>power cord(*1pc)</p>	 <p>instruction(*1pc)</p>	

PRODUCT STRUCTURE

Appearance Structure

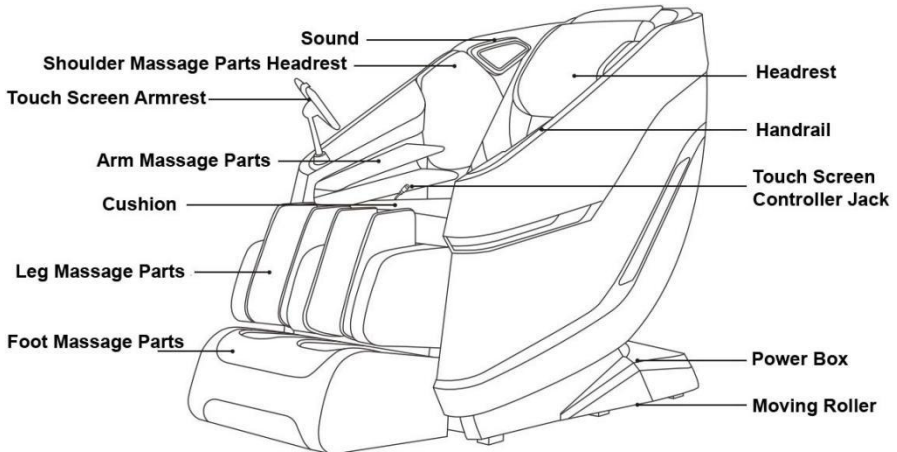

Inner Structure

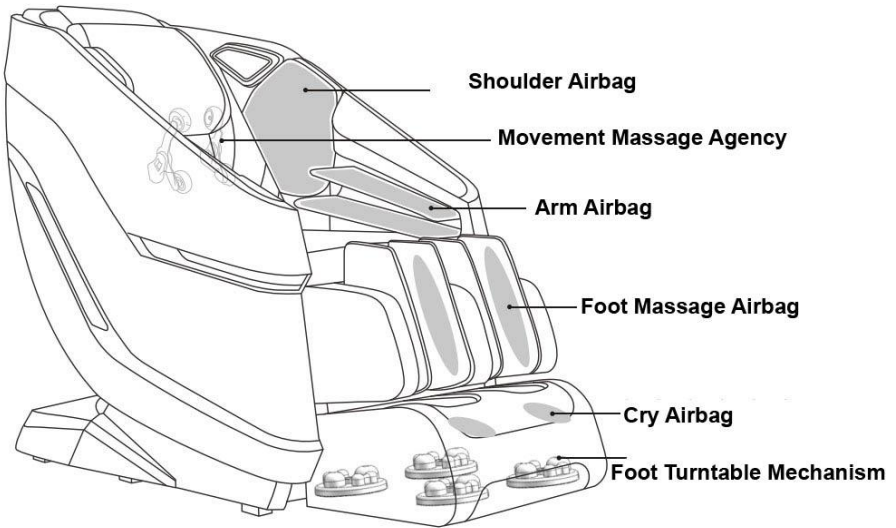

Zero-Gravity Function

There is a slide under the car, sitting on the chair naturally relaxed lying state, will completely release the body pressure, the back and the car linkage design, effectively save the use space of the massage chair.

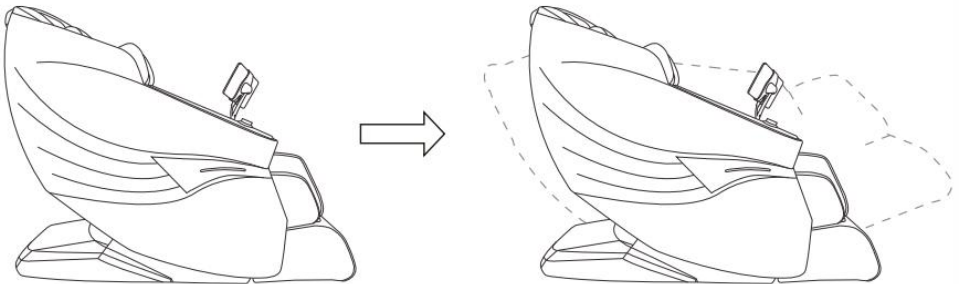

Spring Expansion Leg

The function of leg massage frame. Its expansion capacity reaches about 16cm, which can meet the use of a variety of people of different height.

Air Bag Massage

The product is equipped with multiple parts airbag massage function,34 whole body airbag massage (shoulder, arm, leg and foot airbag massage).

Rotary Massage

The sole of the foot is equipped with 2 rows of massage institutions, can be the sole of the foot, the center of the foot for a full range of finger pressure massage.

Manual Massage Technique

This product design of a variety of massage techniques: kneading, kneading rubbing, tapping, tapping, finger pressure, so that you enjoy the service of the masseuse.

Plate Controller Design

Personalized flat panel button controller design, allow you to use more convenient.

Super-long SL six segment guide rail

Intelligent positioning, for the human neck, shoulder, back, waist, buttocks, legs. customized ultra-long SL six stage guide rail, different massage techniques, private customized your each part of the massage procedures.

CONTROLLER SCREEN

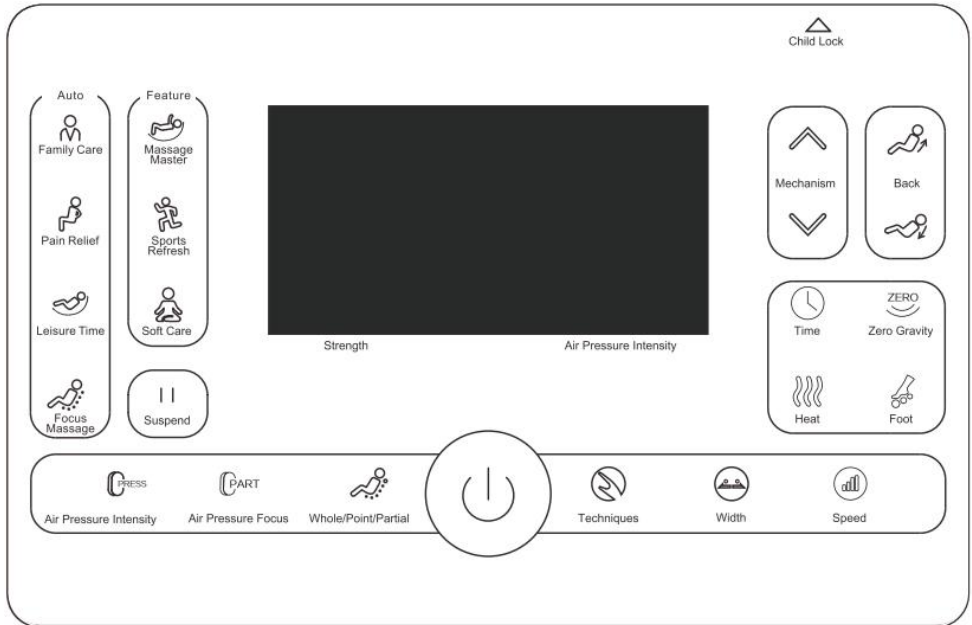

CONTROLLER SCREEN INSTRUCTIONS



Massage Master

With moderate intensity, Massage Master can effectively promote the recovery of body fatigue. Its exclusive massage techniques can help alleviate various discomfort such as sedentary neck shoulder waist and back pain. Combined with soft ambient music, it can help relax the mind and relieve fatigue.



Sports Refresh

Sports Refresh helps relax the whole body. It can effectively relieve muscle pain, neck, shoulder, back, waist, leg and other post-workout discomfort, stretch muscles and bones, relieve tired body and relax tight muscles.



Soft Care

Combined with rhythmic swing, this massage program helps to promote blood circulation and relax body and mind, effectively alleviate various discomfort caused by lack of sleep, such as body discomfort, lethargy, slow response. headache and poor memory. It can calm the mood and melt away tension.

|| Suspend

Press this button to stop the working of massage, press again to continue the massage.



Family Care

Create a personalized exclusive program for ladies who love beauty, so that you can enjoy the SPA massage experience without leaving home. It is your personal masseuse at home.



Pain Relief

Mainly for the neck and shoulders. combined with massage techniques such as kneading, pressing, and neck lifting, it can relieve shoulder and neck fatigue.



Leisure Time

A massage mode suitable for game leisure time, relieving the sense of urgency and muscle tension during focused game play.



Focus Massage

Neck focus, shoulder decompression, back relief, waist care, hip stretch, leg relaxation. Icon flashing prompts.

- **Neck Focus:** Massage for the neck, relieve muscle tension and soreness in the neck. And improve blood circulation in the brain.
- **Shoulder Decompression:** Massage for the shoulders relieves muscle tension and soreness in the shoulders and is good for blood

circulation in the shoulders.

- **Back Relief:** Massage from the shoulder blades to the waist, relieve muscle tension and soreness in the middle and back of the shoulders, and benefit the health of the spleen and stomach.
- **Waist Care:** Massage for the waist, relieve the muscle tension and soreness of the waist, and help to accelerate the elimination of metabolites.
- **Hip Stretch:** The massage for the buttocks relieves muscle tension and soreness in the waist and buttocks, helps to expel toxins from the body and shape the body.
- **Leg Relaxation:** Massage for the buttocks and legs. relieve muscle tension and soreness in the buttocks and legs, and help blood circulation in the legs.



Power button

Press and hold this button to power on/off the controller. Press and hold this button while connected to power to start the massage chair, It defaults to start Massage Master massage program.

Auto Body Scall: Massage chair starts body scan automatically before massager, indicator lights up accordingly.

Adjusting Mechanism Position: When the mechanism positions up/down indicator lights up. you may press and hold the up/down button to adjust the massage roller manually to conform to your shape for a unique personal massage. Press and hold this button again to turn off the massage chair. (The default massage timer is 20minutes)



Air Pressure Level

Press this button to adjust air pressure levels, you may toggle among level 1,2,3,4,5 air pressure intensity settings, the indicator lights up/down accordingly.



Air Pressure Massage

Press this button to choose air pressure massage, you may toggle among upper body air pressure, lower body air pressure, whole body air pressure, air pressure off the indicator lights up/down accordingly.



Whole/Point/Partial

Under manual massage mode, press this button to toggle among whole/point/partial massage mode.

Full Body Massage: Massage mechanism travels up and down along the full back hips and thighs, the indicator blinks accordingly.

Point Massage: Focus the massage on current point, you may move the mechanism up/down by pressing the mechanism up/down adjustment button, the indicator blinks accordingly.

Partial Massage: Focus the massage on current zone, you may move the mechanism up/down by pressing the mechanism up/down adjustment button, the indicator blinks accordingly.



Massage Techniques

Under manual mode press this button to toggle among: kneading, knocking, shiatsu, rubbing, sync and tapping massage techniques, the indicator lights up accordingly.



Massage Width

Under manual mode, press this button to toggle among wide, narrow, medium massage width, the indicator lights up accordingly, Width not adjustable in kneading, rubbing or sync massage mode



Massage Speed

Under manual mode press this button to toggle among level 1,2,3,4,5 speed settings, the indicator lights up accordingly.



Time

Press this key to adjust the massage time, press the adjustment for 5 minutes, 30minutes, and then press for 10 minutes, enter the massage state. Long press the time key to switch on the Bluetooth.



Zero-Gravity

Press this key to open the zero gravity-turn off the zero-gravity massage state cycle switch, the massage chair to open the completely relaxed massage position, enter the space capsule reclining state, release the body pressure and relax the muscles.



Heat

Press this key to open the heating state, and the corresponding icon on the LCD screen lights; press again to turn off the function, the icon is off.



Foot

Press this key to switch on the foot massage.



Mechanism

Long press the upward and down keys to control the movement up and down the corresponding icon light. When the automatic program manually adjusts the shoulder position status during the shoulder inspection, this key can adjust the shoulder massage position.



Back Rise

Long press this key, the backrest is in the rising state, when the rise to their satisfactory position, open the button, stop rising.



Back Down

Long press this key, the backrest is in a downward state, when the drop to their satisfactory position, open the button, stop falling.

MASSAGE CHAIR UNPACKING

- ◆ Open the packing box and remove the accessories.

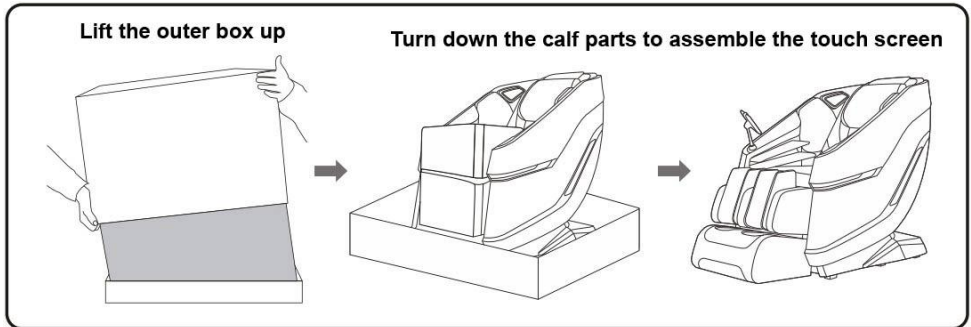

- ◆ Unpack the packaging seal of the outer box of the main body of the massage chair, lift the outer box up and move it out, and turn down the calf parts.
- ◆ Take out the instruction manual, power cord, touch screen, touch screen bracket and other accessories, and put them aside for reserve.
- ◆ Take off the blockage, remove the support parts, rotate on, put the touchscreen, and connect the touch screen controller jack.
- ◆ Organize the products, under the back side of the massage chair, find the main control switch, connect the power cord open the switch, massage ready to complete. (As shown below)

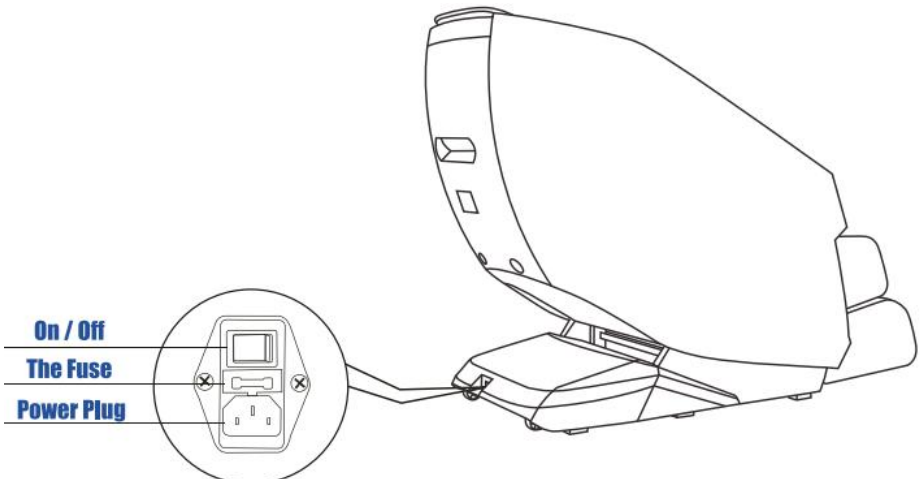



Pay Attention To

- ◆ Do not remove the internal components of the product privately to avoid the possibility of machine failure.
- ◆ Do not splash water or other liquid into the controller to avoid key failure or program error.
- ◆ Do not squeeze the weight into the controller or power cord.

INSTALLATION AND MOVEMENT

Installation Site:

Safe distance around the massage chair:

- ◆ Please place this product in the position with sufficient space: the backrest to the highest and lower to the bottom of the horizontal distance is 16 cm, the calf frame to the highest. The machine forward and the bottom horizontal distance is 30 cm, to ensure that the product
- ◆ behind the distance of more than 16cm, the front of more than 30 cm.
- ◆ Keep a distance of more than 1 meter from audio-visual equipment such as TV and radio to prevent signal interference.
- ◆ When the product is placed, the distance between the power socket and the power switch shall not be more than 1.5 meters.

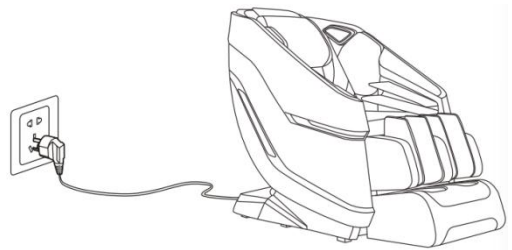
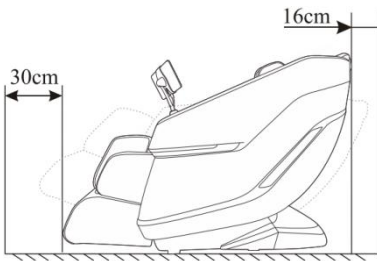

Pay Attention To

- ◆ The distance between the power socket and the power switch shall not be more than 1.5 meters, so as not to break the power cord when smoothing.

- ◆ When using, please straighten out the power cord to avoid wrapping the power cord or damaging the power cord.
- ◆ When the product slides forward or back, please pay attention to whether there are pets, children and other obstacles under or behind the chair, so as to avoid accidents, avoid accidents.

Moving method

- ◆ The bottom of the product is equipped with casters that can be easily moved.
- ◆ Will lift the back back to the highest level.
- ◆ Turn off the power switch and unplug the plug.
- ◆ When moving, lift the front half of the product with the help of the buckle under the handrail, and press the back of the product to move the caster.

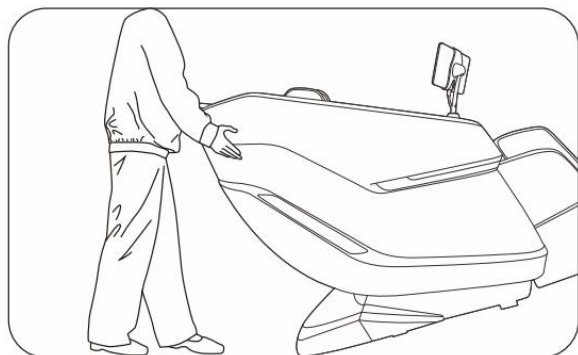

Pay Attention To

- ◆ **Do not** carry the products when carrying people.
- ◆ When moving the product, **do not** use the handrail, ask for the bottom end of the product, hold the back to move (suggest at least 4 people).
- ◆ Because the massage chair is heavy, please be careful not to make it fall when moving in.
- ◆ If the massage chair cannot be carried normally, please contact the purchasing dealer.
- ◆ If the aisle is too narrow, it cannot carry the massage chair normally.

Floor Protection

- ◆ Before use, it is recommended that you lay a carpet and other buffer media under the massage chair to avoid noise or damage to the product and the floor.

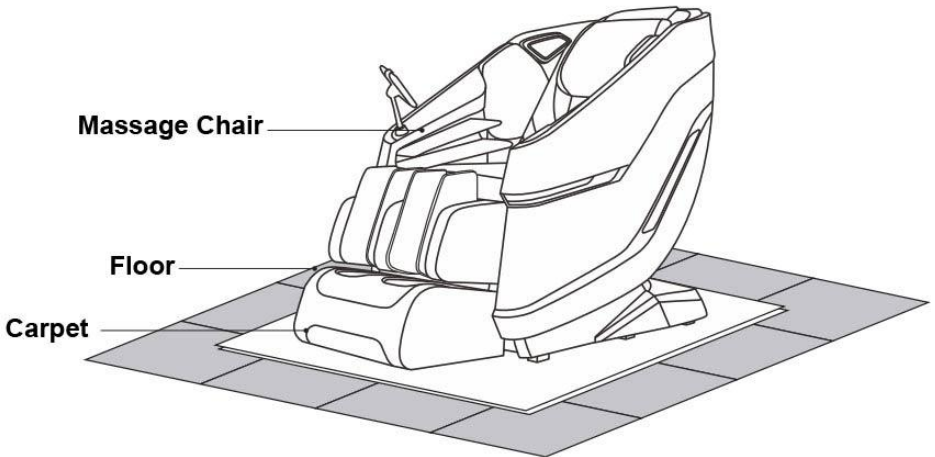

Ambient Environment



Do not place the massage chair in a wet place (such as the bathroom).so as not to prevent the machine moisture leakage.



Do not place the massage chair near the high temperature source (such as a stove) to avoid causing fire or cortex under average.

Landing



This massage chair belongs to class I electrical appliances, be sure to use three core power sockets please confirm that the ground wire on the power socket is well grounded, so as not to avoid the adverse consequences of leakage in the process of use.

PRECAUTIONS BEFORE USE

Attention:

- Do not extend your hands, fingers, feet and head into the gap between the lower leg and the seat or armrest.
- Please make sure that there is nothing between all parts of the appliance before seating.
- Do not put your hands, arms or head between the backrest and the back cover.
- Do not put the pet on the massage (seat, backrest, handrail, leg etc.).

1. Machine Debugging

- ◆ Use the controller to put the back rest frame to the extreme position, lift the calf frame to the highest position and extend to the longest position, before the operation to ensure that there is plenty of space around the massage chair.
- ◆ After testing the functions are correct, make the massage chair completely reset and turnoff the power switch. (Please refer to the "LCD screen icon menu description" for the massage selection procedure.)

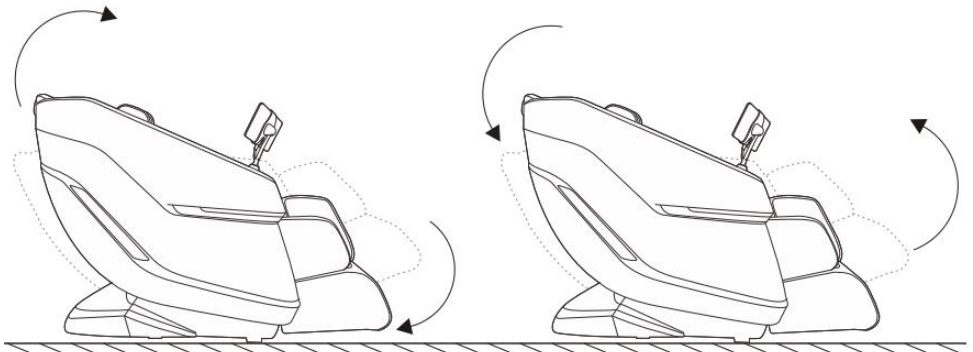

Pay Attention To

- ◆ Do not sit when the calf massage frame is raised.
- ◆ Do not suddenly make the calf massage frame under too much pressure, otherwise it may damage the mechanical structure.

2. The Calf Stretch

- ◆ Hard foot step, you can adjust the relative position of the calf massage frame and the calf, so that the calf massage is in the best position.

The leg massage frame sticks out to ←

The calf massage frame will retract by one →

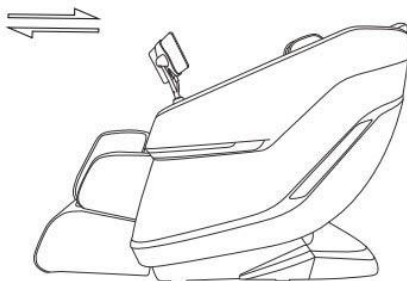

- ◆ When using, adjust to the appropriate position according to the calf position.

Warning

- ◆ Play in the chair and improper operation.
- ◆ When adjusting the Angle of the calf and backrest parts, first confirm that there are no obstacles around the product.
- ◆ It is strictly prohibited to insert the legs, feet or other objects into the chair space when the calf parts are extended or.

3. Turn on the power

Please make sure that there is nothing in the leg, foot and other positions before the massage.

- 1) Plug the power plug into the power supply socket.

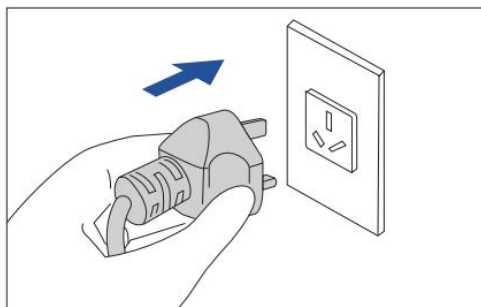

2) Press the power switch at the lower back of the product to the "I" (on) position.

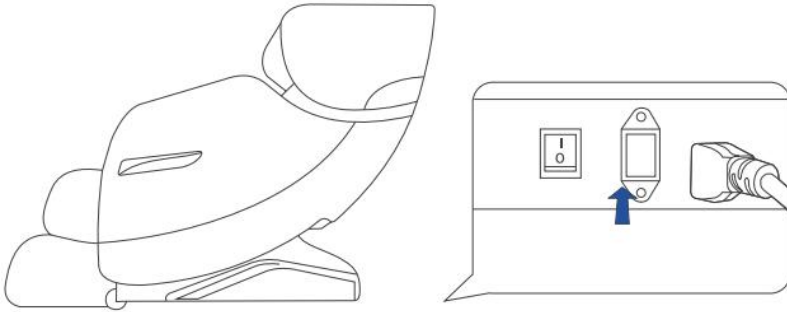

Attention

- Check whether the power cord and plug are damaged before use.
- Please make sure that there is nothing between all parts of the appliance before seating. Make sure power is fully plugged in completely. Otherwise, it may cause electric shock or overheat and cause a fire.
- Please use the following power supply specifications:
110VAC~120VAC,60Hz (US); 220VAC~240VAC,50Hz (EU/AUS).
- Do not connect the transformer without permission. It may cause fire by electric shock, body failure or overheating.
- Do not plug or unplug the power plug with wet hands.

4. Bluetooth pairing

Turn on Bluetooth on your device to search for the model's name of the machine("BH-6223") and connect to it. Music played back from the device will output from the chair's built-in speaker.

CLEANING THE LEATHER SURFACE

Wipe leather with a piece of dry cloth:

- Do not use chemicals such as diluents, gasoline and alcohol to clean the appliance.
- When using the leather maintenance products (rags) on the market, please follow the instructions.
 - 1) Dip the soft cloth in water or hot water with 3% to 5% neutral detergent (without friction agent) and screw it out completely.
 - 2) Wipe the leather surface with the soft cloth.
 - 3) Wipe off the cleaning fluid with a cloth that has been soaked in clean water and completely wrung dry.
 - 4) Wipe with a soft, wring dry cloth.
 - 5) Let it dry naturally.
- If it is difficult to remove the stains, please dip the trioxide foam purchased on the market into the neutral detergent and then use it to wipe the appliance.
- Do not use a blower to dry the surface
- Do not use denim or coloured fabric to wipe the appliance because the colour of the cloth will be dyed on the surface of synthetic leather.
- Please cover the contact part with a towel when using hair dye because synthetic leather may change colour.

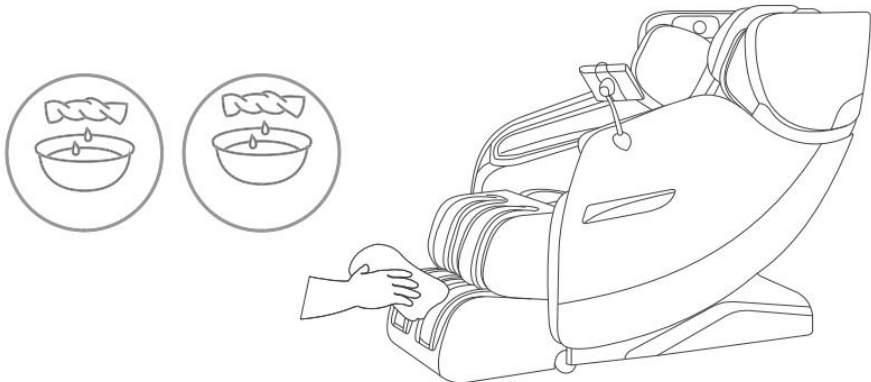

CLEANING THE PLASTIC SURFACES

Wipe leather with a soft dry cloth

- Immerse the soft cloth in water or hot water containing neutral detergent, screw it dry and wipe the plastic part of the appliance. Do not use chemicals such as diluents, gasoline, alcohol, etc. to clean the machine.
- Wipe with a cloth soaked in water and thoroughly wrung dry. Before wiping the remote control, please make sure to wring it dry.
- Let it dry naturally.

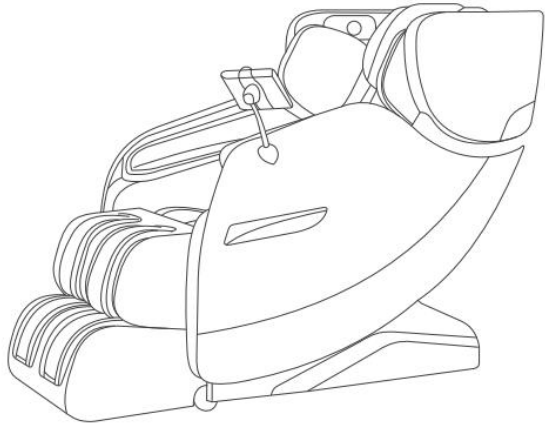
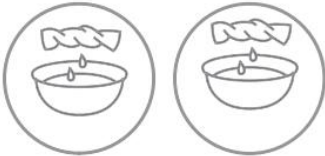

After using

- ◆ After using the massage chair, please turn off the power switch, and unplug the power plug from the power socket.
- ◆ In order to avoid accidents caused by children accidentally starting the massage chair. Turn off the power switch when not using the massage chair, and then remove the power plug from the power socket.
- ◆ If you do not use it for a long time, please collect the massage chair.

MAINTENAN AND STORAGE

Maintenance

- ◆ Rear cover, armrest, leg massage frame and other plastic parts and the dirt, please use cotton cloth soaked in neutral detergent, wring dry wipe, after all wipe, and then carefully wipe with dry cloth.
- ◆ Wipe the dirt at the controller, power box or other parts, with a dry cloth.
- ◆ The dirt at the back cushion and pillow cushion, please wipe.



Warning

- ◆ For maintenance, be sure to unplug the power plug. Do not insert your wet hands to avoid electric shock and injury. When wiping the back cover, beware of detergent entering the power box!
- ◆ Do not use benzene or diluent and other corrosive detergent to clean the product otherwise it may cause the product..

Storage

- ◆ After removing dirt and dust, if it is not used for a long time, please cover with dustcover (prepared) to avoid dust.



Pay Attention To

Do not place the product in a place of direct sunlight or high temperature, so as not to fade the product lining.

Kindly Reminder

During perennial use, be sure to check for the following symptoms:

- ◆ Have a burnt smell.
- ◆ After touching the wire, sometimes power on, sometimes power off.
- ◆ Power cord is heating



Pay Attention To

- ◆ If the above phenomenon occurs, to prevent faults and accidents, please stop using the massage chair.
- ◆ Cut off the power switch, unplug the power plug, and contact the distributor or the company where you purchased this product.
- ◆ Except for the above normal operation and maintenance, any Unplug the power supply during maintenance. Do not insert your wet hands to avoid any cause Warning electric shock and injury.

FAQ

Q: Concerned about the sound of massage chair operation.

A: The sound produced by the operation of the massage chair is generally caused by the structure of the movement.

Q: What height range is this product suitable for?

A: When users with height less than 145cm or over 185cm use upper body massage and calf and foot massage at the same time, they may have insufficient contact between foot and foot massage or knee bending.

Q: Feel too much pressure on the foot.

A: Use the airbag button to set the airbag strength to the weakest gear. In addition, reduce the calf, foot massage, can also reduce the pressure of the foot.

Q: What should we pay attention when moving?

A: Please note the following:

- Please recline the back of massage chair to the lowest position to make moving easier.
- Do not sit on the seat when moving
 - 1) Press the button to turn on the power.
 - 2) Press "zero gravity" to fully recline the backrest.
 - 3) Turn off the power switch and pull out the power plug.
- In the case of original cartons, please make sure that the power cord is not wrapped on the appliance and put the power cord on the

seat surface. When handling, please note that the power cord does not fall and rub with the ground.

- In the absence of original cartons, to prevent scratches and vibration during handling, please properly use other packaging auxiliary materials to wrap the product.

Q: Can people who often go to the hospital because of illness use this product?

A: People who often go to the hospital should consult with the doctor before using this product. Massage called "touch pressure stimulation" through the compression of muscles, relieve muscle tension and promote blood flow. According to the different pathogen, massage may cause deterioration of the condition. Consult with the master doctor before using this product.

Q: How many power consumptions monthly when using this product?

A: According to 30 minutes per day, the power consumption of this product is about 1.5kwh per month.

Q: Does it matter if feel that there is a difference in the massage strength between the left and right massage wheels.

A: Due to the structure of the movement, it is possible to feel the difference in the strength of the left and right massage wheels during the massage process.

To simulate the most natural massage technique, the movement of this product adopts the movement structure that allows the left and right massage wheels to beat the back alternately. In the process of massage, the specific position of the left and right massage wheels contacting the back may be slightly different, which leads to different feeling of massage strength on the left and right sides. The product is normal now.

Q: What age group is the massage chair suitable for?

A: This massage chair is suitable for people aged from 18 to 75. Minors and the elderly must be accompanied by a guardian when using this appliance.

TROUBLESHOOTING

If there is still any abnormality after the following inspection, please stop using immediately, unplug the power plug from the socket, and contact the dealer to prevent accidents.

PHENOMENON	CAUSINGISSUE	SOLUTIONS
There are "sex "and "clicking" sounds in the movement	Normal emitted when the motor is operating normally Sound or the sound off friction between the ball and the cloth sleeve	There is no need for any processing
Can't boot	The power plug is not plugged in properly	Plug in the power plug
	The power switch is not on	Beat the power switch in the On the "open position On the "open "position
	The fuse of the massage chair is damage	If damaged, replace the fuse of the same type
The backrest frame or calf massage frame cannot be fitted or lowered	Too much pressure was applied to the back and calf massage frame	Reduce the pressure on the back or calf, massage frame
If there are any abnormalities with the above treatment, please contact the local dealer for maintenance.	Whether the air duct is not blocked	Straighten out the trachea
The speaker has no sound	The volume was turned up foe minimum	Turn the volume up
Stop in massage	Excessive force	Lift the body a little, or raise the back slightly

Do not disassemble and repair the product without authorization.
Our company will not be responsible for any product damage or personal injury caused thereby!
Thank You for Your Cooperation.

Manufacturer: Shanghaimuxinmuyeyouxiangongsi

Address: Shuangchenglu 803nong11hao1602A-1609shi, baoshanqu, shanghai 200000 CN.

Imported to AUS: SIHAO PTY LTD. 1 ROKEVA STREETEASTWOOD NSW 2122 Australia

Imported to USA: Sanven Technology Ltd. Suite 250, 9166 Anaheim Place, Rancho Cucamonga, CA 91730



YH CONSULTING LIMITED.

C/O YH Consulting Limited Office 147,
Centurion House, London Road,
Staines-upon-Thames, Surrey, TW18 4AX



E-CrossStu GmbH

Mainzer Landstr.69,
60329 Frankfurt am Main.

VEVOR[®]

TOUGH TOOLS, HALF PRICE

Technical Support and E-Warranty Certificate

www.vevor.com/support