

VEVOR[®]

TOUGH TOOLS, HALF PRICE

Technical Support and E-Warranty Certificate www.vevor.com/support

MC SERIES MPPT SOLAR CHARGE CONTROLLER MC2430N10-B/ MC2440N10-B/ MC2450N10-B

USER MANUAL

We continue to be committed to provide you tools with competitive price.

"Save Half", "Half Price" or any other similar expressions used by us only represents an estimate of savings you might benefit from buying certain tools with us compared to the major top brands and does not necessarily mean to cover all categories of tools offered by us. You are kindly reminded to verify carefully when you are placing an order with us if you are actually saving half in comparison with the top major brands.

VEVOR®

TOUGH TOOLS, HALF PRICE

MC SERIES MPPT SOLAR CHARGE

MODEL:MC2430N10-B/ MC2440N10-B/ MC2450N10-B

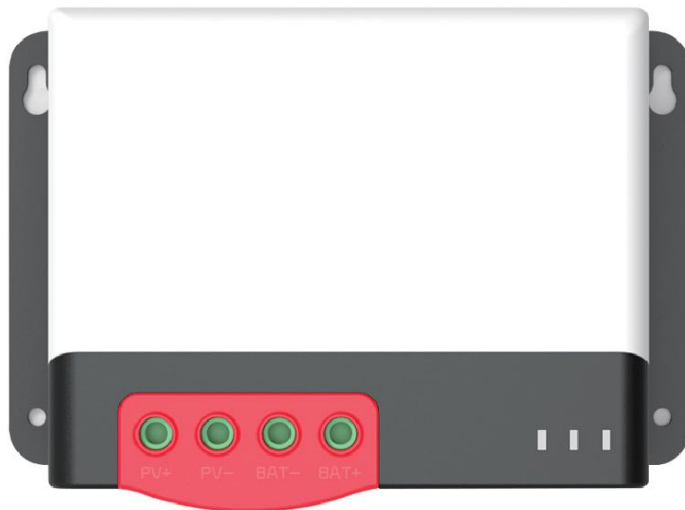



NEED HELP? CONTACT US!

Have product questions? Need technical support? Please feel free to contact us:

Technical Support and E-Warranty Certificate
www.vevor.com/support

This is the original instruction, please read all manual instructions carefully before operating. VEVOR reserves a clear interpretation of our user manual. The appearance of the product shall be subject to the product you received. Please forgive us that we won't inform you again if there are any technology or software updates on our product.

	<p>Warning-To reduce the risk of injury, user must read instructions manual carefully.</p>
	<p>This device complies with Part 15 of the FCC Rules. Operation is subject to the following two conditions:(1)This device may not cause harmful interference, and (2)this device must accept any interference received, including interference that may cause undesired operation.</p>
	<p>This product is subject to the provision of European Directive 2012/19/EC. The symbol showing a wheeled bin crossed through indicates that the product requires separate refuse collection in the European Union. This applies to the product and all accessories marked with this symbol. Products marked as such may not be discarded with normal domestic waste, but must be taken to a collection point for recycling electrical and electronic devices</p>

Model	MC2430N10-B	MC2440N10-B	MC2450N10-B
Battery voltage	12V/24V		
Max. PV open circuit voltage	92V(25°C); 100V(Lowest ambient temperature)		
Charge current	30A	40A	50A
Max. PV input power	400W/12V 800W/24V	520W/12V 1040W/24V	660W/12V 1320W/24V

Dear users, Thank you very much for choosing our products!

SAFETY INSTRUCTIONS

1. Applicable voltage of the controller exceeds the safety voltage for human body, so please read the manual carefully before use and operate the controller only after safety operation training has been completed.
2. There are no parts inside the controller that need to be maintained or repaired. The user shall not disassemble and repair the controller.
3. Install the controller indoors to prevent exposure of components and prevent water from entering the controller.
4. Please install the controller in a well-ventilated place to prevent the heat sink from being overheated.
5. It is recommended to install a proper fuse or circuit breaker outside the controller.
6. Be sure to disconnect the wiring of PV array and the fuse or circuit breaker near battery terminal before installation and wiring adjustment of the controller.
7. Check that all wiring is tight after installation to avoid danger of heat accumulation due to poor connections.



Warning: This operation is dangerous, so before operation, safety preparations must be made.



Caution: This operation may have a destructive effect.



Reminder: Suggestions and tips for operator.

Table of Contents

1. Introduction.....	05
2. Installation.....	13
3. Product Operation and Display.....	17
4. Product Protection and System Maintenance.....	20
5. Technical Parameters.....	23
6. Conversion Efficiency Curve.....	25
7. Product Dimensions.....	26

1. INTRODUCTION

1.1 Overview

- With industry-leading PowerCatcher MPPT technology, the MC series solar charge controller enables maximum energy tracking for solar panels. This technology allows the controller to quickly and accurately track the maximum power point of PV array in any environment, obtain the maximum energy of solar panels in real time, and significantly increase energy utilization efficiency of the solar energy system.
- This product can be connected to an external LCD screen or Bluetooth communication module and PC Upper Computer for dynamic display of operating status, operating parameters, controller logs, control parameters, etc. The user can look up various parameters and can modify the control parameters as needed to suit different system requirements.
- The controller adopts standard Modbus communication protocol, which is convenient for the user to view and modify the parameters of the system. Meanwhile, the company provides free monitoring software that can maximize the convenience for users to meet different needs of remote monitoring.
- The controller provides overall electronic fault self-test and powerful electronic protection functions which minimize components damage due to installation error and system failure.

1.2 Features

- PowerCatcher maximum power point tracking technology allows the controller to track the maximum power point of solar panels even in a complex environment. Compared with the traditional MPPT tracking technology, it boasts faster response speed and higher tracking efficiency.
- A built-in maximum power point tracking (MPPT) algorithm can significantly increase energy utilization efficiency of the photovoltaic

system, which is about 15% to 20% higher than traditional PWM charging.

- It provides an active charging voltage regulation feature. At battery open circuit or lithium battery BMS overcharge protection, the controller battery terminal will output the rated charging voltage value.
- MPPT tracking efficiency is up to 99.9%.
- Due to advanced digital power technology, the circuit energy conversion efficiency is as high as 98%.
- Available in multiple battery types and support charging procedures of various types of batteries such as lithium battery, colloidal battery, sealed battery, vented battery, lithium battery, etc.
- A current-limited charging mode is available. When the power of solar panel is too large and the charging current is higher than the rated value, the controller automatically reduces the charging power so that the solar panel can operate at the rated charging current.
- Support automatic identification of lead-acid battery voltage.
- External LCD screen or Bluetooth module can be connected for viewing of equipment operating data and status, and modification of controller parameters is supported.
- Optional built-in Bluetooth function, which can view the running data and status of equipment and support the change of controller parameters.
- Optional built-in CAN function, which can view the running data and status of equipment and support the change of controller parameters.
- Support standard Modbus protocol to meet communication needs in different occasions.
- Built-in over-temperature protection mechanism ensures that when temperature exceeds the set value of the device, the charging current decreases linearly with the temperature, thereby reducing the temperature rise of controller and avoiding high temperature damage.
- Temperature compensation and automatic adjustment of charge and discharge parameters help to improve battery life.
- Solar panel short circuit protection, battery open circuit protection and TVS lightning protection, etc.

1.3 Appearance

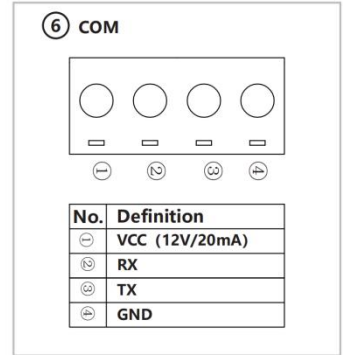

Figure 1-1 Controller Appearance and Ports

No.	Names	No.	Names
①	Solar panel "+" interface	⑥	Communication Interface
②	Solar panel "-" interface	⑦	Operation keys
③	Battery "-" interface	⑧	PV charging indicator
④	Battery "+" interface	⑨	Battery level indicator
⑤	External temperature sampling interface	⑩	Battery type indicator

1.4 MPPT Technology Introductions

The Maximum Power Point Tracking (MPPT for short) system is an advanced charging technology that enables the solar panel to output more energy by adjusting operating conditions of the electrical module. Due to the non-linear characteristics of solar arrays, there is a maximum energy output point (maximum power point) of an

array on its curve. Traditional controller (switch charging technology and PWM charging technology) fails to maintain battery charging at this point, and therefore the maximum energy of the solar panel cannot be obtained. The solar charge controller with MPPT control technology, however, can track the array's maximum power point at all time to obtain the maximum energy to charge the battery.

Take a 12V system as an example. Peak voltage (V_{pp}) of the solar panel is about 17V, while the battery voltage is about 12V. In general, when the controller is charging the battery, the voltage of solar panel is about 12V and does not fully contribute to its maximum power. But, MPPT controller can overcome this problem. It constantly adjusts the input voltage and current of the solar panel to achieve the maximum input power. Compared to the traditional PWM controller, the MPPT controller can provide the maximum power of the solar panel and thus can provide a larger charging current. In general, the MPPT controller can improve energy utilization by 15% -20% compared with the PWM controller.

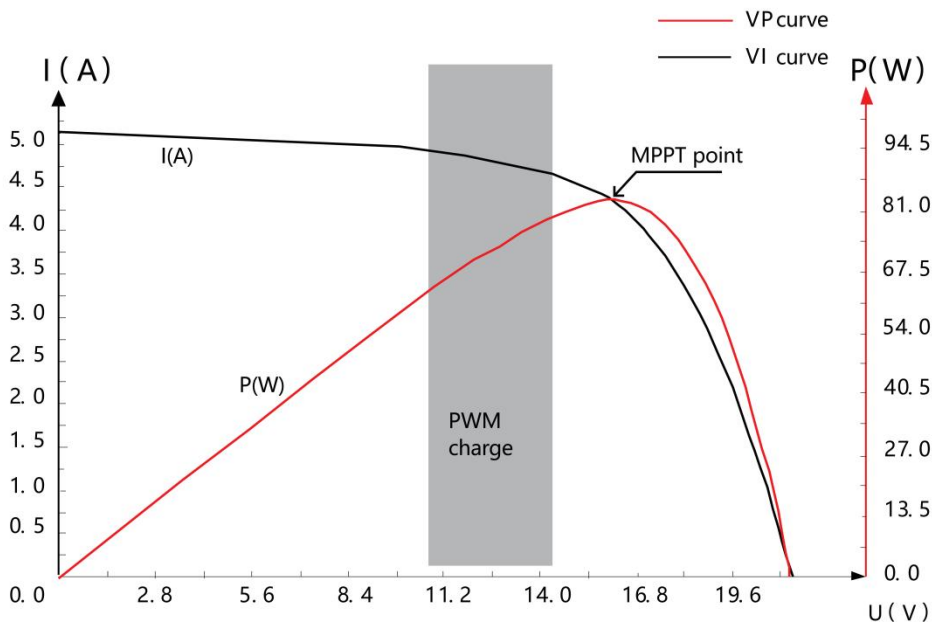

Figure 1-2 Solar panel output characteristics curve

In addition, due to the difference in ambient temperature and light conditions, the maximum power point often changes. The MPPT controller can adjust parameters according to different conditions from time to time to keep the system near its maximum working point. The whole process is fully automatic and does not require any adjustments by users.

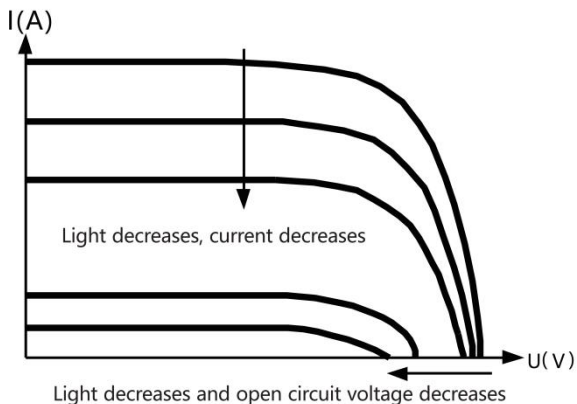

Figure 1-3 Relationship between solar panel output characteristics and light

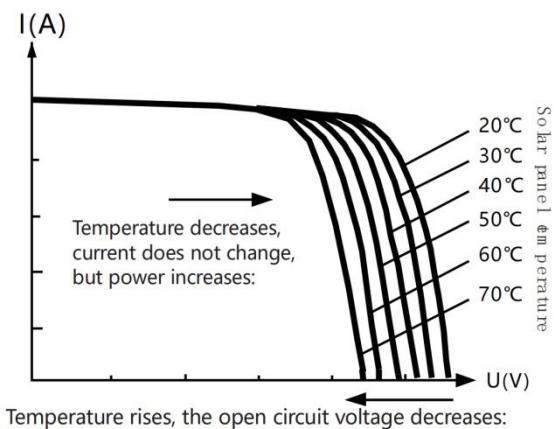

Figure 1-4 Relationship between solar panel output characteristics and temperature

1.5 Charging Stage Introductions

As one of the charging stages, MPPT cannot be used alone. It is usually required to combine boost charge, floating charge, equalizing charge and other charging methods to complete the battery charging process. A complete charging process includes: Quick charge, holding charge and floating charge. Charging curve is shown below:

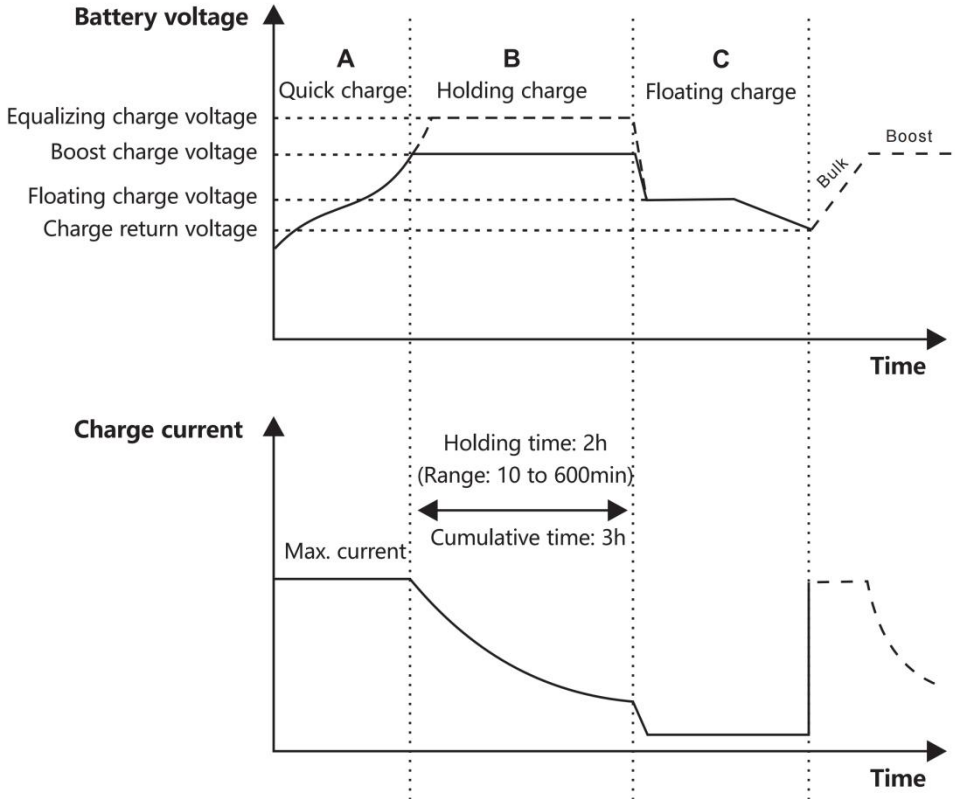

Figure 1-5 Battery charging stages curve graph

a) Quick charge

In quick charge stage, the battery voltage has not yet reached the set value of full charge voltage (i.e. equalizing/boost charge voltage) and the controller will perform MPPT charging, which will provide maximum solar

energy to charge the battery. When the battery voltage reaches the pre-set value, constant voltage charge will start.

b) Holding charge

When the battery voltage reaches the set value of holding voltage, the controller will perform constant voltage charging. This process will no longer include MPPT charging, and the charging current will gradually decrease with time. Holding charge comes in two stages, i.e. equalizing charge and boost charge. The two stages are conducted without repetition, in which equalizing charge is started once every 30 days.

➤ **Boost charging**

The default duration of boost charge is 2 hours. The customer can also adjust the holding time and the pre-set value of boost voltage point according to actual needs. When the duration reaches the set value, the system will switch to floating charge.

➤ **Equalizing charging**



Warning: Risk of explosion!

Equalizing vented lead-acid batteries may generate explosive gases. So, the battery compartment must be well ventilated.



Caution: Damage to the device!

Equalization can increase the battery voltage to levels that may damage sensitive DC loads. It is necessary to verify that the allowable input voltage of all system loads is greater than the equalizing charge set value.



Caution: Damage of device!

Over charge and excessive gas evolution may damage the battery plates and cause active substances on the battery plate to come off. Equalizing charge may cause damage if voltage is too high or time is too long. Please carefully check the specific requirements of battery used in the system.

Certain types of battery benefit from regular equalizing charge, which can stir electrolytes, balance battery voltage, and complete chemical reactions. Equalizing charge increases the battery voltage above standard voltage,

causing vaporization of battery electrolyte. If it is detected that the controller automatically controls the next stage to be equalizing charge, the equalizing charge will last for 120 minutes (default). The equalizing charge and boost charge are not repeated in a full charge process to avoid too much gas evolution or battery overheating.

1) When the system cannot continuously stabilize the battery voltage at a constant voltage due to the influence of installation environment or load, the controller will accumulate time until the battery voltage reaches the set value. When the accumulated time reaches 3 hours, the system will automatically switch to floating charge.

2) If controller clock is not calibrated, the controller will perform regular equalizing charges according to its internal

Floating charging

Floating charge is conducted following the holding charge stage, where the controller will reduce the battery voltage by reducing charge current and allowing the battery voltage to remain at the floating charge set value. During the floating charge stage, the battery is charged in a very low voltage to maintain full charge state of the battery. In this stage, the load can get nearly all of the solar energy. If the load exceeds the energy that solar panel can provide, the controller will not be able to maintain the battery voltage in the floating charge stage. When the battery voltage is as low as the recovery charge set point, the system will exit floating charge stage and re-enter the fast charge stage.

2. INSTALLATION

2.1 Installation Precautions

Be very careful when installing the battery. When installing the vented lead-acid battery, wear protective glasses. Once you touch the battery acid, rinse it with clean water.

Avoid placing metal objects near the battery to prevent battery short circuit. Acid gas may be generated when the battery is charged. So ensure good ventilation.

The battery may generate flammable gas. Please keep away from sparks. Avoid direct sunlight and infiltration of rainwater when installing outdoors. Poor connection points and corroded wires may cause extreme heat to melt the wire insulation layer, burn the surrounding materials, and even cause fire. Therefore, it is necessary to ensure that the connectors are tightened, and the wires preferably fixed with a cable tie to avoid loose connectors caused by wire shaking.

In system wiring, output voltage of the component may exceed the safety voltage of human body. So, it is necessary to use insulated tools and ensure that the hands are dry.

Battery terminal on the controller can be connected with either a single battery, or a pack of batteries. Subsequent instructions in the manual are for a single battery, but it also applies to a battery pack.

Observe the safety recommendations of battery manufacturer.

The system connection wires are selected according to the current density of not more than 4A/mm². Make the controller grounded.

2.2 Wiring Specifications

Wiring and installation must comply with national and local electrical code requirements.

PV and battery connection wires must be selected according to rated current. Refer to the following table for wiring specifications:

Models	PV maximum Input current	Max. wire diameter at PV end(mm ² /AWG)	Rated charge current	Battery wire diameter (mm ² /AWG)
MC2430N10-B	30	8/8	30A	8/8
MC2440N10-B	40	10/7	40A	10/7
MC2450N10-B	50	12/6	50A	12/6

2.3 Installation and Wiring

Warning: Danger, Explosion! Never install the controller and a vented battery in the same enclosed space! Also do not install in an enclosed place where battery gas may collect.

Warning: Danger, High Voltage! Photovoltaic arrays may generate very high open circuit voltages. Disconnect circuit breaker or fuse before wiring and be very careful during wiring.

Caution: When installing the controller, ensure that there is enough air to flow through the controller's heat sink, leaving at least 150mm above and below the controller to ensure natural convection for heat dissipation. If install in a closed box, ensure reliable heat dissipation through the box.

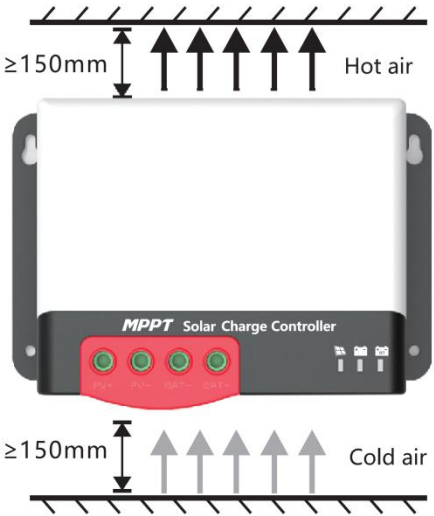

Figure 2.1 Installation and Heat Dissipation

Step 1: Choose an installation location

Avoid installing the controller in a place free of direct sunlight, high temperature, and water, and ensure good ventilation around the controller.

Step 2: Mark the mounting position according to the mounting dimensions of the controller. Drill 4 mounting holes of the appropriate size at the 4 marks. Fix screws into the upper two mounting holes.

Step 3: Fasten the Controller

Align fixing holes of the controller with the two pre-fixed screws and hang the controller up. And then fix the lower two screws.

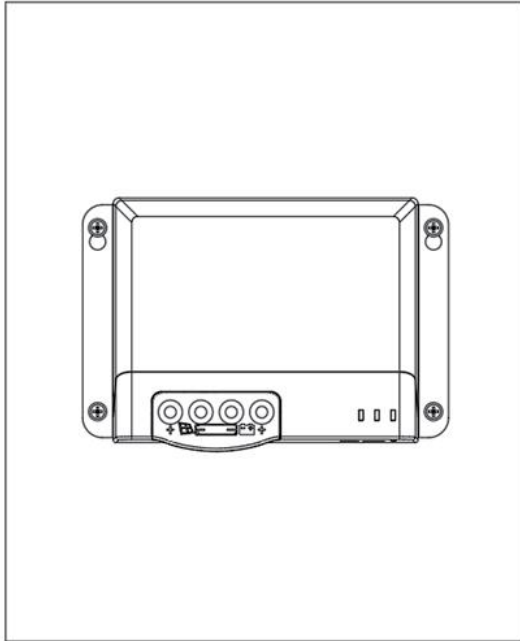

Step 4: wire

For installation safety, we recommend a wiring sequence as follows; however, wiring in other sequences instead of this one will not damage the controller.

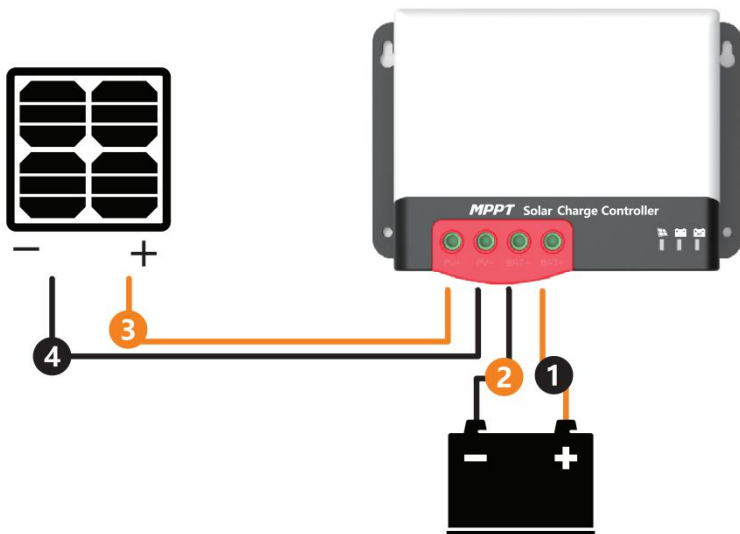

⚡ Warning: Danger, Electric shock hazards! We strongly recommend connect a fuse or circuit breaker to the PV array and battery terminals to prevent electric shock hazards during wiring or error operation, and make sure that fuse or circuit breaker is disconnected before wiring.

⚡ Warning: Danger, High voltage hazards! Photovoltaic arrays may generate very high open circuit voltages. Disconnect circuit breaker or fuse before wiring and be very careful during wiring.

⚡ Warning: Danger, Explosion hazards! If the positive and negative terminals of battery and the wires connected to them are short-circuited, it may cause a fire or explosion. Please be very careful in operation. Please connect the battery first, and then the solar panel. Please follow the “+” first and “-” next method when wiring.

When all wires are connected firmly and reliably, check whether the wiring is proper and whether the polarity is reversed. After confirmation, connect the battery fuse or circuit breaker and observe whether the LED indicator is on. If not, disconnect the fuse or circuit breaker immediately and check

whether wiring is correct.

As the battery is properly energized, connect the solar panel. If there is sufficient sunlight, the charge indicator of controller will be steady on or flash and start to charge the battery.

 **Warning:** When the controller has stopped charging for 10 minutes, reverse polarity of the battery can damage the controller's internal components.

Note:

1) Note that the battery fuse shall be installed as close as possible to the battery terminal. The recommended distance is not more than 150mm.

2) The battery temperature is 25°C (fixed value) when the controller is not collected to a remote temperature sensor.



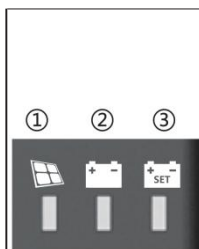

3. PRODUCT OPERATION AND DISPLAY

3.1 LED Indicators

There are a total of three indicators on the controller

	① ---PV array indication	Indicate the current charging mode of controller
	② ---BAT indication	Indicate the current state of battery.
	③ ---BAT Type indication	Indicate the current battery type.

➤ **PV array indicator:**

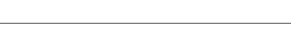
No.	CHARGE STATUS	Indicator state	Charging state
①	 BULK	Steady on	MPPT charging
②	 ACCEPTANCE	Slow flashing (On:1s, off: 1s, cycle: 2s)	Boost charging
③	 FLOAT	Single flashing (On:0.1s, off: 1.9s, cycle: 2s)	Floating charging
④	 EQUALIZE	Quick flashing (On:0.1s, off: 0.1s, cycle: 0.2s)	Equalizing charging
⑤	 CURRENT-LIMITED	Double flashing (On:0.1s, off: 0.1s, then, On:0.1s, off: 1.7s, cycle: 0.2s)	Current-limited charging
⑥		Off	No charging

➤ **BAT indicator:**

Indicator color	Indicator status	Battery status
Green	Steady on	Battery full charge
Yellow	Steady on	Battery voltage normal
Red	Steady on	Battery voltage below under-voltage point
	Quick flash (On:0.1s, off: 0.1s, cycle: 0.2s)	Battery over-voltage or over temperature

➤ **BAT Type Indication:**

Indicator color	Battery status
Green	Sealed lead-acid battery
Yellow	Colloidal lead-acid battery
Red	Vented lead-acid battery
Blue	Lithium iron phosphate battery 12V
Purple	Lithium iron phosphate battery 24V
White	Custom

3.2 Keys Operation

There is a key on the controller, which is used in conjunction with the battery type indicator for selection of battery type. The specific operation mode is as follows:

In the current operating state, press and hold the key for 8 seconds. The battery type indicator (the color displayed is that of the previously saved battery type) starts to flash (the controller turns off charging and other works and enters an idle state). At this point, each time the key is pressed, the battery type indicator changes a color that corresponds to a battery type. After the battery type is selected, press and hold the key for 8 seconds again or maintain no operation for 15 seconds. Then, the controller will automatically save the currently set battery type and enter the normal operating mode;

In addition, if you press and hold the key for 20s, the controller will restore the factory default parameters.

3.3 TTL Communication

Users can utilize external communication equipment (such as Bluetooth BT-2) or communication protocol to perform data monitoring, parameter setting and other operations for the controller via the port.

The interface is defined as follows:

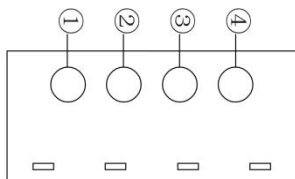

No.	Definition
①	Controller supplies +12.8V outwards.
②	Data receiving terminal RX of controller
③	Data sending terminal TX of controller
④	GND

3.4 CAN communication

Optional built-in CAN communication function and RV-C protocol.

S/N	Definition
①	/
②	/
③	/
④	GND
⑤	/
⑥	/
⑦	CANH
⑧	CANL

4. PRODUCT PROTECTION AND SYSTEM MAINTENANCE

4.1 Protections

➤ Waterproofing protection

Rating: IP32

➤ Input power limited protection

When the power of solar panel is higher than the rated value, the controller will limit the power of solar panel within the rated power range to prevent damage by over current, and the controller will enter the current-limiting charge.

➤ Battery reverse polarity protection

If the battery polarity is reversed, the system will not work but it will not burn out the controller.

➤ **PV input end voltage is too high**

If the voltage at the PV array input end is too high, the controller will automatically shut off the PV input.

➤ **PV input end short circuit protection**

If the voltage at the PV array input end is short circuited, the controller will turn off charging; after short circuit is removed, charging will automatically recover.

➤ **PV input reverse polarity protection**

When the polarity of PV array is reversed, the controller will not be damaged, and normal operation will continue after wiring error is corrected.

➤ **Night reverse charging protection**

Prevent battery discharge through the solar panel at night.

➤ **TVS lightning protection**

➤ **Over-temperature protection**

When temperature of the controller exceeds the set value, it will reduce charging power or stop charging.

4.2 System Maintenance

- In order to maintain the best long-term performance for controller, it is recommended to conduct inspections twice a year.
- Make sure the airflow around the controller is not obstructed and remove any dirt or debris from the heat sink.
- Check if the insulation layers of all exposed wires are damaged due to sun exposure, friction with other objects nearby, dry rot, destruction of insects or rodents, etc. If so, it is necessary to repair or replace the wire.
- Verify if indicators are consistent with the device operations. Please note to take corrective actions for any malfunctions or error indications if necessary.
- Check all wiring terminals for corrosion, insulation damage, signs of high temperature or burning/discoloration.

Tighten terminal screws.

- Check for dirt, insects nesting and corrosion and clean as required.
- If the lightning arrester has failed, replace it in time to protect controller and other devices of the user from being damaged by lightning operations. Please note to take corrective actions for any malfunctions or error indications if necessary.

 Warning: Danger, electric shock hazards! Make sure that all power supplies to the controller have been disconnected before check or operation as above.!

5. TECHNICAL PARAMETERS

5.1 Electrical parameters

Items	Parameters			
Model		MC2430N10-B	MC2440N10-B	MC2450N10-B
System voltage	12V/24V			
Zero load loss	<10mA			
Battery voltage	9V~32V			
Maximum PV open circuit voltage	92V(25°C); 100V(Lowest ambient temperature)			
Maximum power point voltage range	(Battery voltage +2V) ~ 72V			
Rated charging current		30A	40A	50A
Maximum PV input power		400W/12V	550W/12V	660W/12V
		800W/24V	1100W/24V	1320W/24V
Charging conversion efficiency	≤98%			
MPPT tracking efficiency	>99%			
Temperature compensation coefficient	-3mV/°C/2V (default); Lithium battery features no temperature compensation			
Operating temperature	-35°C to 45°C			
IP rating	IP32			
Weight		830g	1040g	1335g
Communication mode	TTL Serial communication			
Optional features	Built-in bluetooth and CAN communication			
Altitude	≤ 3000 meters			
Dimensions (mm)		150*105.6*67.5	183*127*65.5	183*127*69.5
Description:				
Optional built-in bluetooth communication function, the corresponding product model is MC24xxN10-B. XX stands for 20/30/40/50.				
Optional built-in can communication function, the corresponding product model is MC24xxN10-CAN. XX stands for 20/30/40/50.				

5.2. Battery type default parameters

Comparison of parameters of various types of battery					
Set voltage Battery type	Sealed lead-acid battery	Colloidal lead-acid battery	Vented lead-acid battery	Lithium battery	User defined
Overvoltage disconnection voltage	16.0V	16.0V	16.0V	—	9 ~ 17V
Equalizing charge voltage	14.6V	—	14.8V	—	9 ~ 17V
Boost charge voltage	14.4V	14.2V	14.6V	14.4V	9 ~ 17V
Floating charge voltage	13.8V	13.8V	13.8V	—	9 ~ 17V
Boost charge recovery voltage	13.2V	13.2V	13.2V	—	9 ~ 17V
Equalizing charge duration	120 min.	—	120 min.	—	0 ~ 600 min.
Equalizing charge interval	30 days	0 days	30 days	—	0 ~ 250D (0 indicates turning off equalizing charge function)
Boost charge duration	120 min.	120 min.	120 min.	—	10 ~ 600 min.

If a user-defined battery is used, the default voltage parameters of the system are the same as those of the sealed lead-acid battery. The following logic must be followed when you modify battery charge and discharge parameters:

Overvoltage disconnection voltage > charge limit voltage \geq equalizing charge voltage \geq boost charge voltage \geq floating charge voltage > boost charge recovery voltage;

Overvoltage disconnection voltage > Overvoltage disconnection recovery voltage;

6. CONVERSION EFFICIENCY CURVE

6.1 12V System

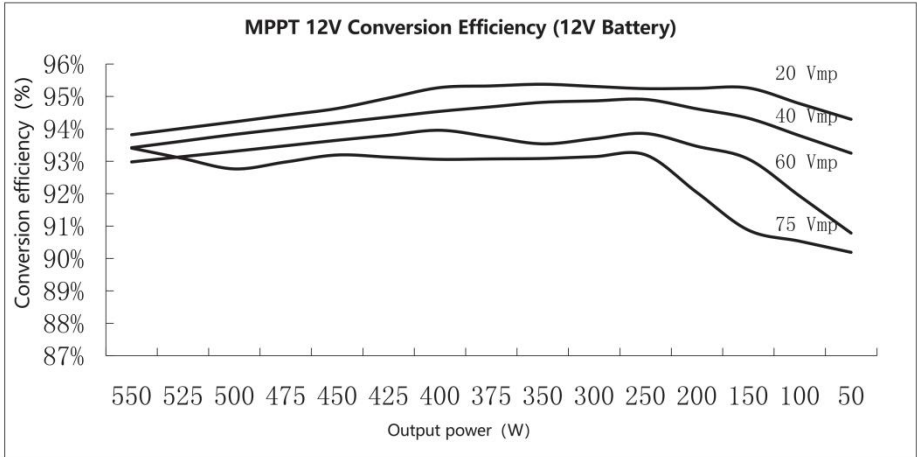

6.2 24V System

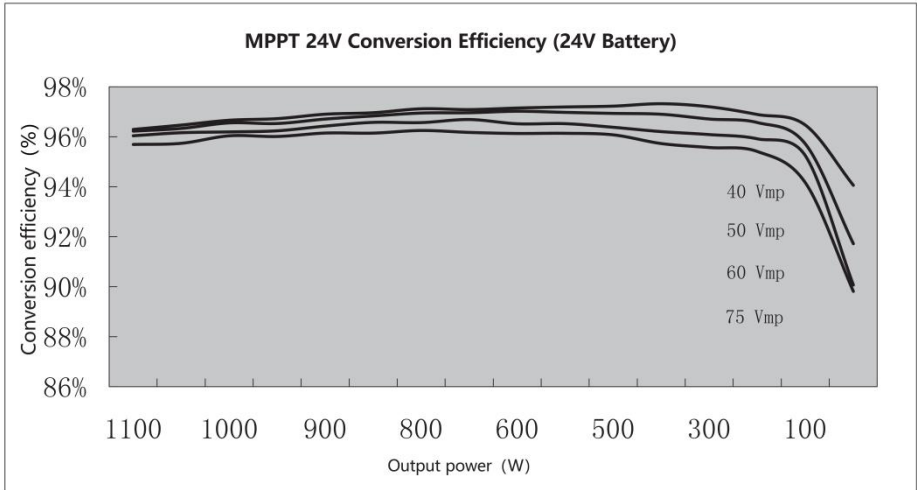

7. PRODUCT DIMENSIONS

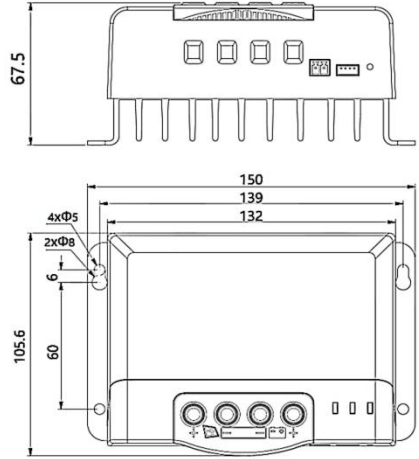

Model: MC2430N10-B;
 Outline dimensions: 150*105.6*67.5mm;
 Mounting dimensions: 139*60mm;
 Fixed holes dia: Φ 5mm;
 Wire specifications: 20-6AWG.

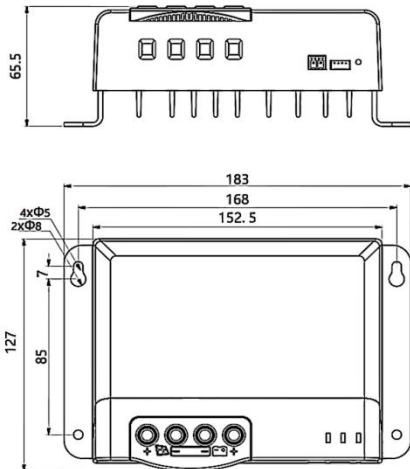

Model: MC2440N10-B;
 Outline dimensions: 183*127*65.5mm;
 Mounting dimensions: 168*85mm;
 Fixed holes dia: Φ 5mm;
 Wire specifications: 20-6AWG.

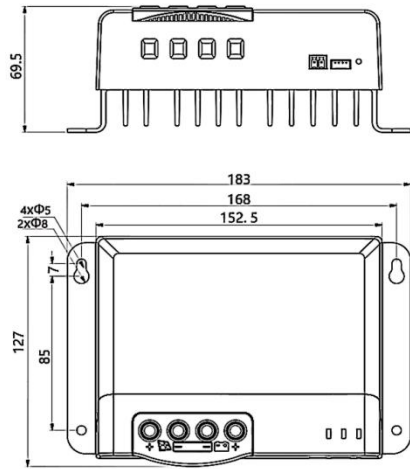

Model: MC2450N10-B;
 Outline dimensions: 183*127*69.5mm;
 Mounting dimensions: 168*85mm;
 Fixed holes dia: Φ 5mm;
 Wire specifications: 20-6AWG.

Address: Baoshanqu Shuangchenglu 803long 11hao 1602A-1609shi
Shanghai

Imported to AUS: SIHAO PTY LTD, 1 ROKEVA STREETEASTWOOD
NSW 2122 Australia

Imported to USA: Sanven Technology Ltd., Suite 250, 9166 Anaheim
Place, Rancho Cucamonga, CA 91730



Pooledas Group Ltd
Unit 5 Albert Edward House, The Pavilions
Preston, United Kingdom



SHUNSHUN GmbH
Römeräcker 9 Z2021, 76351
Linkenheim-Hochstetten, Germany

Made In China

VEVOR[®]

TOUGH TOOLS, HALF PRICE

Technical Support and E-Warranty Certificate

www.vevor.com/support