

# ***Instruction Manual***

---

## **VARIABLE SPEED MINI LATHE**

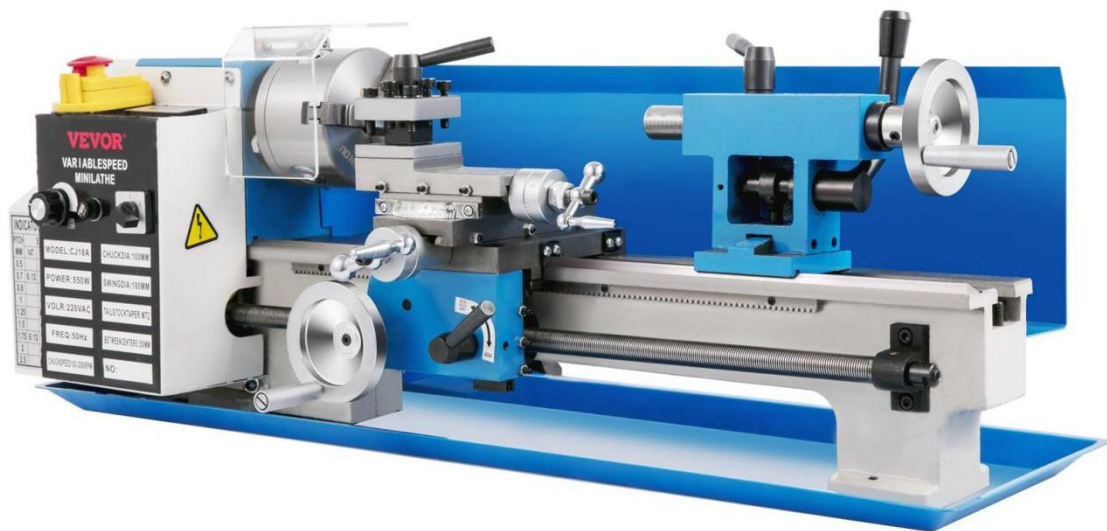

Before Using Be Sure To Read This Manual.

This Machine is Suitable To Use Only From 12°C~35°C (53.6°F~95°F)

# **Content**

---

1. Safety Rules For Lathe
2. Product Features
3. The Main Part Of A lathe
4. Grounding And Insulation
5. Adjustment And Prepartion
6. Operation And Replacement
7. Gear Mounting
8. Machine Considerations

# **Safety Rules For Lathe**

---

1. Before you turn on the motor, be sure that you have put in suitable lubrication according to manual's instruction. Also check carefully to see all the tool work-pieces etc. are in proper positions.

2. Always use your hand to dismount the chuck or the lathe's face plate. Do not use power tools.

3. After installation of the chuck, remove the wrenches and tools in order not to cause any accidents when the machine is turned on.

4. When the lathe is on, do not use a wrench to fix or adjust the workpiece or any other rotating parts of the machines.

5. When the machine is in motion, do not use any instruments to measure the machine, nor test the sharpness of the cutter with your hand.

6. Do not use too large a tool cutter to do your feeding with too large a workpiece. This will easily cause an accident because of a broken workpiece.

7. Always use the right tools and stand at the proper position when performing your work.

8. Do not change the gear when the machine is in operation.

9. Always keep a proper distance from the machine in order to avoid being struck by a broken workpiece.

## **product Features**

---

1) This precision mini lathe is designed to perform various types of processing jobs. Counterface turning drilling,threading. and cutting jobs on materials made up of round bar and bar materials can be per formed with this machine.This machine can be used in areas such as mini preci sion parts processing. sample processing and modeling works.

2)The lathe bed is made of high grade iron.The rigidity of lathe,the handness and accuracy of the v-slideways are obtained by raw materials,heat hardening and grinding.

3)This machine is DC motor driven.

4) The spindle speed is variable from zero to 2500RPM.

5)The feed speed can be adjusted according to the requirements of different work-pieces.

# The main part of a lathe

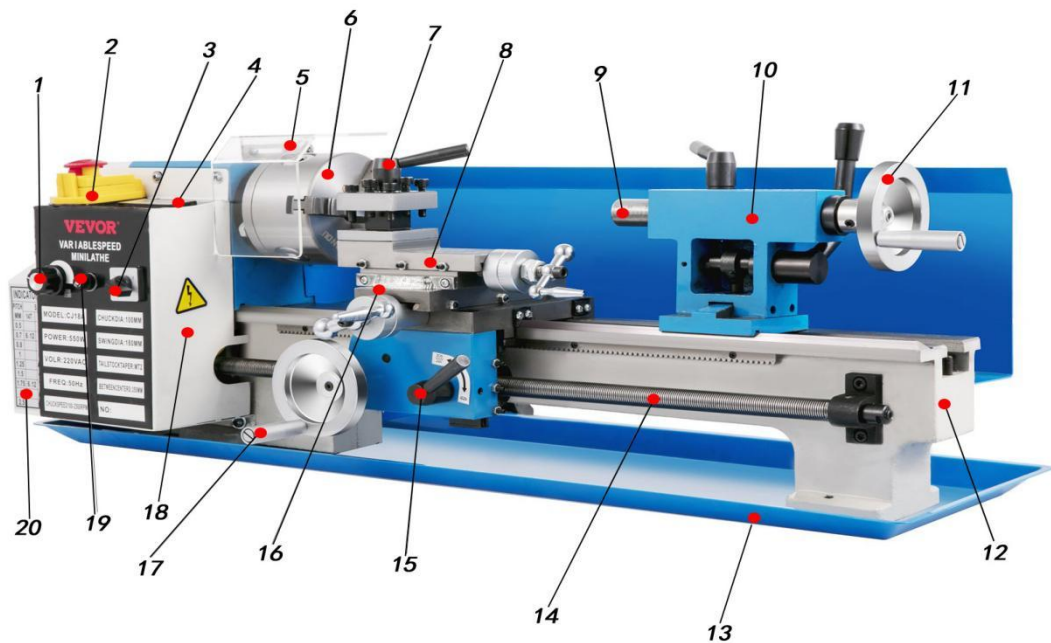

1.Speed control knob	11.Aluminum handwheel
2.Emergency stop switch	12.Metal bed
3.Forward-revrse switch	13.Scrap tray
4.Digital display screen	14.Lead screw
5.Splash protection goggles	15. Automatic feed handle
6.Three-jaw Chuck	16. Big Drag Board
7.Knife Holder	17. Feed the handwheel
8.Small pallets	18. Control Box
9.Tailstock sleeve	19.Fuse wire
10.Tail seat handwheel	20.Gear table

# Grounding And Insulation

---

1. In the event of a malfunction or break-down, grounding provides a path of least resistance for electric current to reduce the risk of electric shock. This tool is equipped with an electric cord having an equipment-grounding conductor and a grounding plug. The plug must be plugged into a matching outlet that is properly installed and grounded in accordance with all local codes and ordinances.
2. Do not modify the plug provided even if it will not fit the outlet, have the proper outlet installed by a qualified electrician.
3. Improper connection of the equipment grounding conductor can result in a risk of electric shock. The conductor with insulation having an outer surface which is green with or without yellow stripe is the equipment-grounding conductor. If repair or replacement of the electric cord or plug is necessary, do not connect the equipment-grounding conductor to a live terminal.
4. Check with a qualified electrician or serviceman if the grounding instructions are not completely understood, or if in doubt as to whether the tool is properly grounded.
5. Use only 3-wire extension cords that have 3-prong grounding plugs and 3-pole receptacles that accept the tool's plug.
6. Repair or replace damaged or worn cord immediately.

## **Adjustment And Preparation**

---

1. Clean off grease on the machine.
2. Check that the 3 set screws of the chuck are tight.
3. Turn the chuck by hand and check if it rotates freely.
4. Move the Feeding direction selector from the back of back of the body to the middle.
5. First shut off the switch ①. Adjust the switch ③ by turning to "o" position and turn the switch ② to STOP position. If the lathe needs to be started, turn the switch ① according to direction marked on switch to the normal position and turn the switch ② to FORWARD or REVERSE position. The spindle will turn immediately by turning the switch ③. The speed can be adjusted by turning the switch ③. If the lathe needs to be stopped, turn the switch ③ to "0" position. If the direction of the lathe spindle needs to be changed the switch ③ must be turned to "o" position at first. If the lathe must be stopped under emergency situation, press the Emergency Switch ① immediately. If the lathe needs to be started again, do so again according to the above mentioned process.

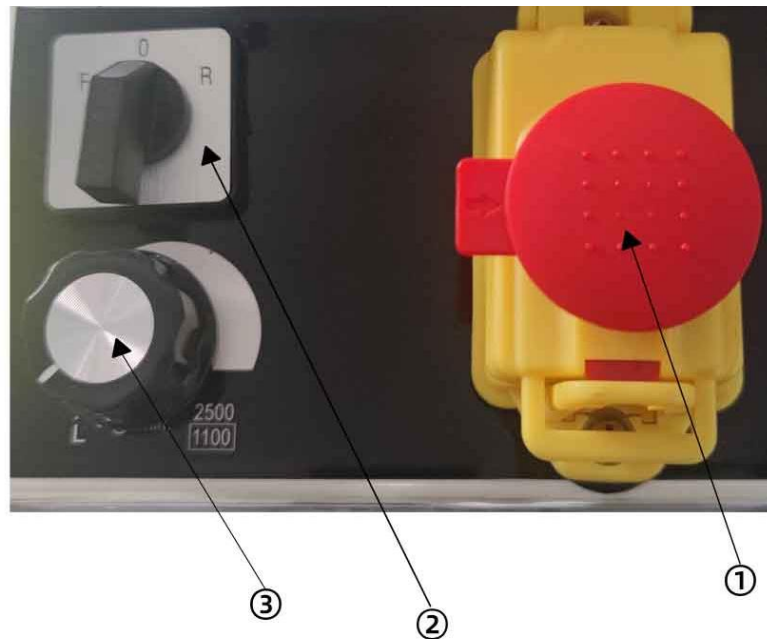

- 1. Emergency stop switch**
- 2. Forward-reverse switch**
- 3. Speed control knob**

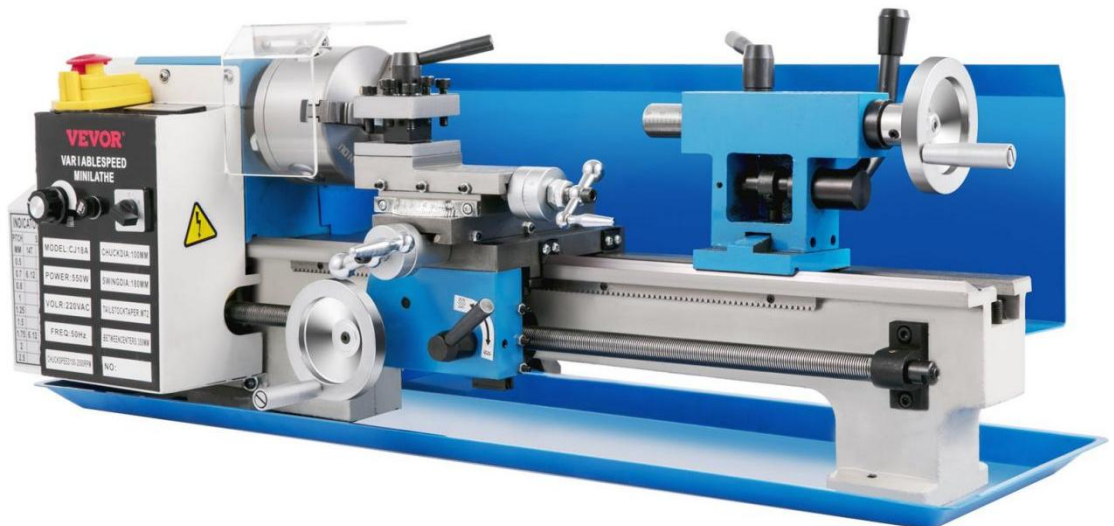

**Check the compound restcrank and the cross feeding crank and see if they work properly. If they are too tight or too loose, turn the adjusting screws located at both sides.**



# Operation & Replacement

---

## Replacement of chuck

When replacing the chuck, place a cloth or a piece of wood on the bed way at the bottom of the chuck. This is to avoid damage to the bed way caused by carelessly dropping the chuck. Loosen the 3 set screws as shown in Fig. (A) to re- place the chuck.

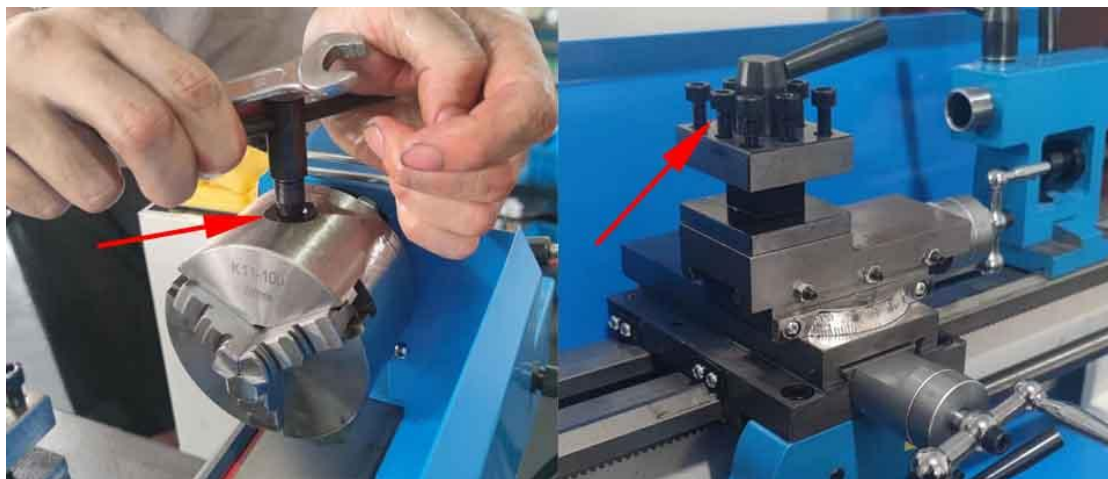

A

Fig.1 Replacement of Jaws Fig.2 Composite tool rest adjustment

## Replacement of Jaws

There are two types of jaws: Internal and external. Please note that the number of jaws. ws fit with the number inside the chuck's groove. Do not mix them together. When you are going to mount them, please mount them in ascending order 1-2-3, when you are going to take them out, be sure to take them out in descending order(3-2-1) one by one. After you finish this procedure, rotate the jaws to the smallest diameter and check that the three jaws are well fitted. if not you need to reassemble them again as they are not properly assembled(Fig.1).When you are going to mount the work piece you need only to loosen one jaws. However, we recommend you loosen the three jaws at the same time, In this way you can protect them and will not damage the thread inside.

## Composite tool rest adjustment

Loosen the two screws as shown in (A)of Fig.2. After you have obtained the angle you desire, please do not forget to tighten them.

## Tailstock rest adjustment

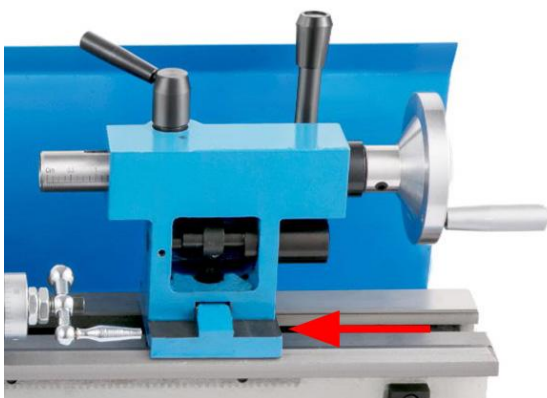

When you are going to change position or replace the tailstock you need to loosen the nut as shown in (A) of Fig.3.

A Fig.3 Tailstock Rest Adjustment

## Replacement of carbon brushes

Replace the carbon brushes by removing the brush covers both on Motor cover as shown in A of Fig.4-A and the right bottom side of speed controller as shown in B of Fig.4-B.

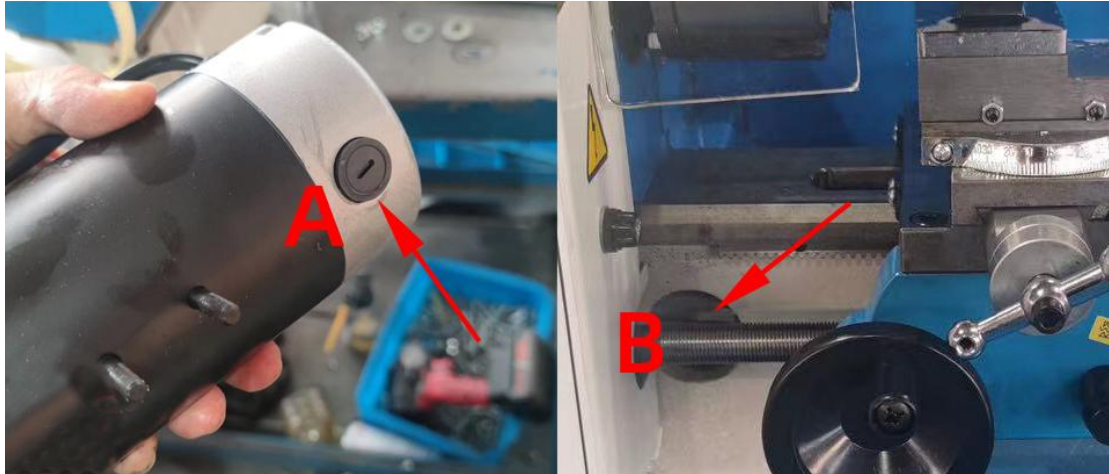

A Fig.4 Replacement of carbon brushes

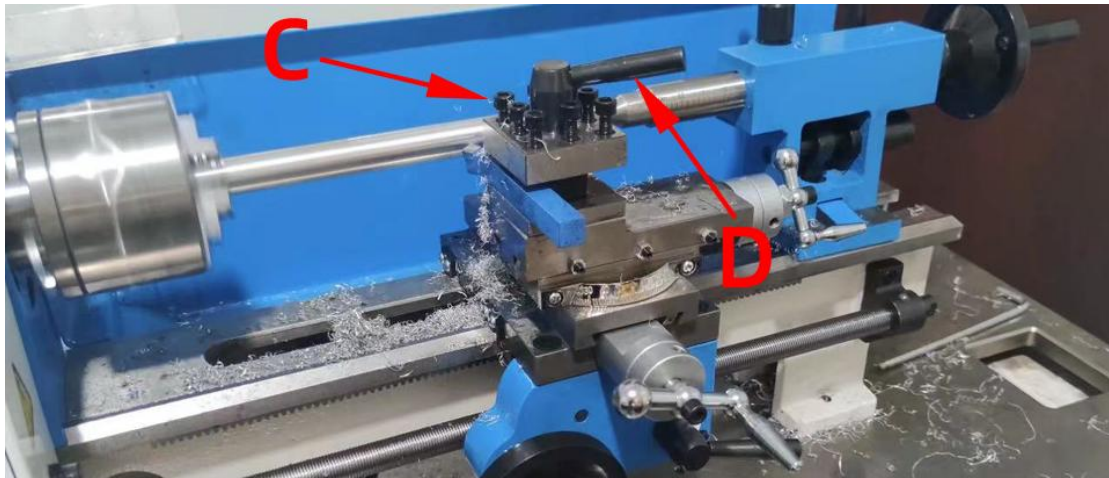

Fig.5 Tool rest adjustment

## Tool rest adjustment

When you are going to adjust the tool post position, you only need to loosen the lever shown in(D)of Fig.5. After you have finished be sure to tighten. if you are going to replace the work cut- ter then you need to loosen the screws of (C) with the allen wrench provided.

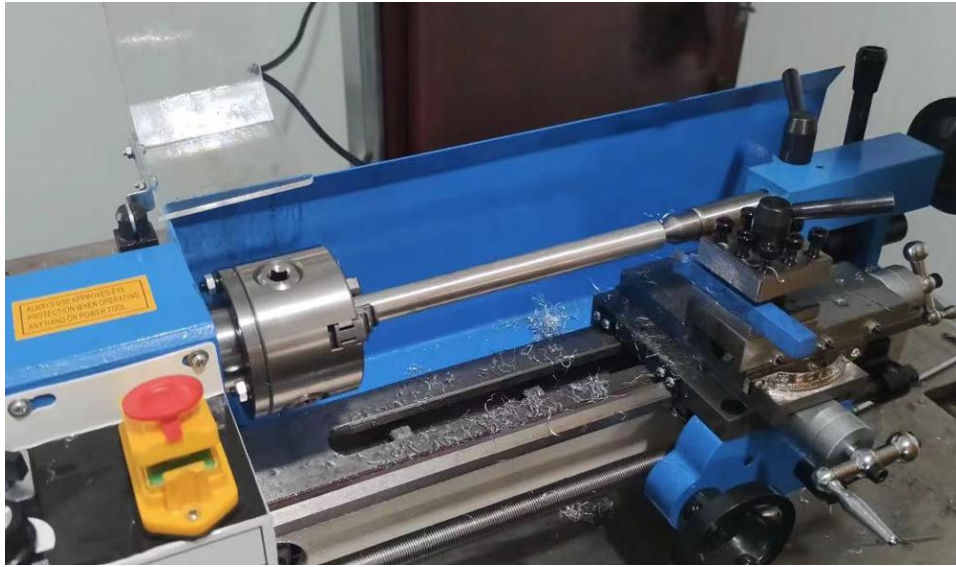

Fig 6 Workpiece Holding And Drilling

Use the chuck to hold the workpiece firmly Then, use the center to fix the other end. if you change the center to drilling chuck you can start your drilling immediately.(Fig.6)



Fig7 Face Cutting

Use the chuck to hold the workpiece firmly and the cutter to start lathe's face cutting as shown in Fig. 7 (edge of the cutter must be at the same height as the center)

# Gear Mounting

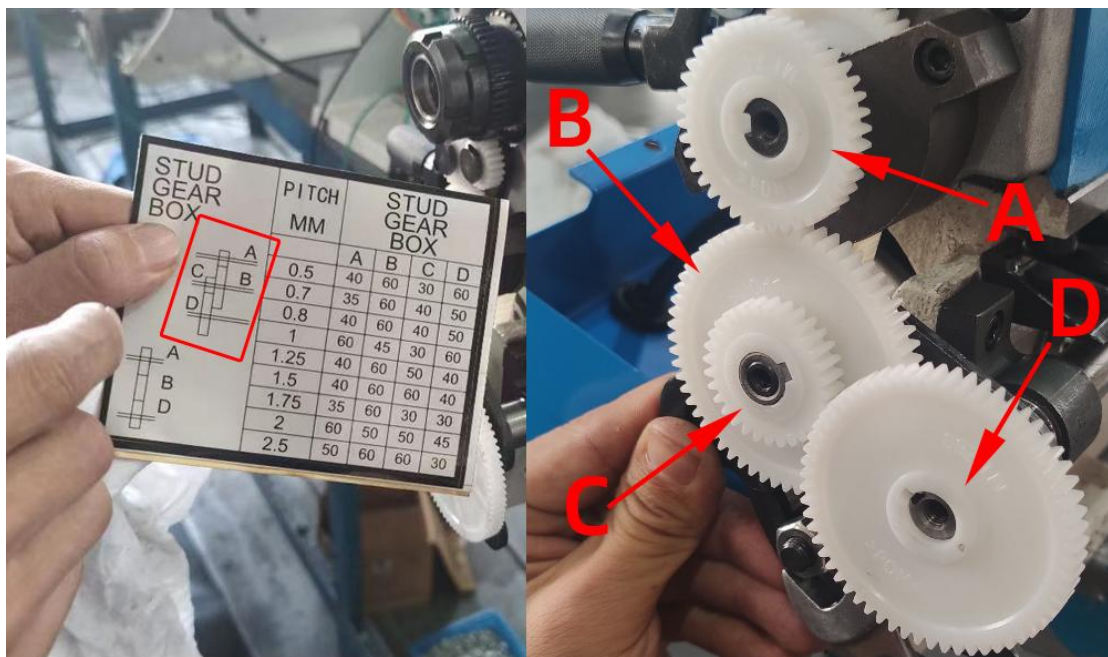
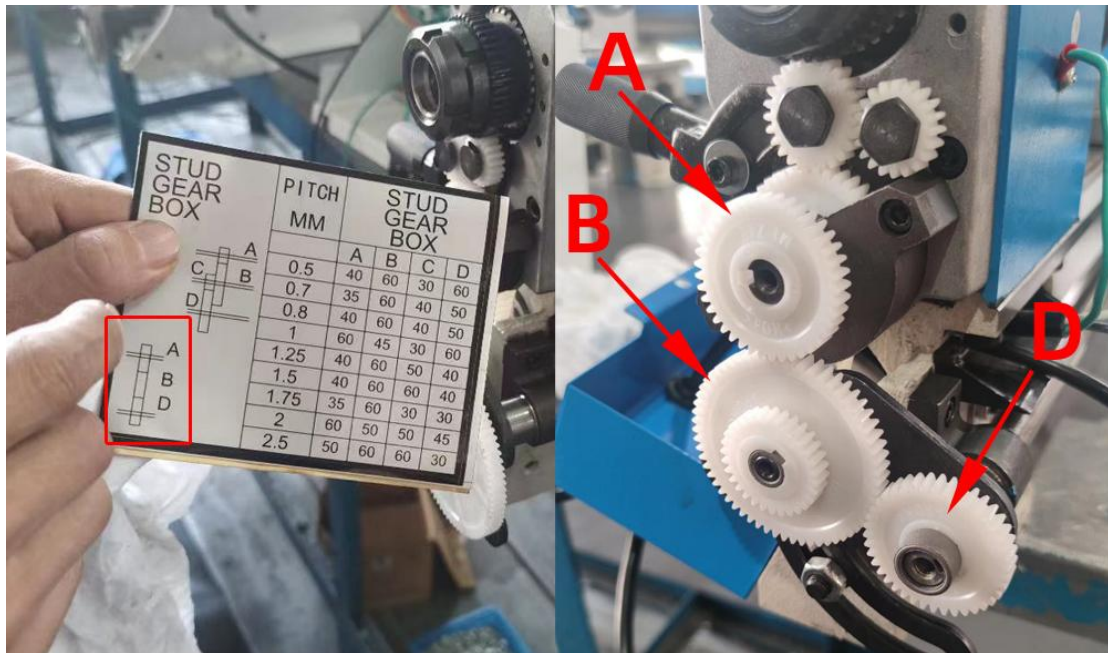

The corresponding gear can be replaced according to the gear list. After gear replacement, the gears need to be interlocked with each other.(Replaceable Metal Gear)

# Machine Considerations

---

1. Turn on the machine to check whether the home power supply is consistent with the purchase machine voltage (220V or 110V)
2. Please follow these steps to start the lathe. 1 press the forward and reverse switch (F or R)2, then press the green button switch 3 and finally rotate the speed control switch.
3. If you encounter a non-startup situation (1) . Power supply is normal power, check whether the voltage is stable. (2) . Check if the fuse is broken. (3) . Whether the motor is working properly (4) . Open the white control box and check for loose wiring inside. (5). Whether to start the lathe according to the starting order.