

# **VEVOR<sup>®</sup>**

**TOUGH TOOLS, HALF PRICE**

Technical Support and E-Warranty Certificate [www.vevor.com/support](http://www.vevor.com/support)

## **WHITE BOARD**

## **INSTRUCTION MANUAL**

We continue to be committed to provide you tools with competitive price. "Save Half", "Half Price" or any other similar expressions used by us only represents an estimate of savings you might benefit from buying certain tools with us compared to the major top brands and does not necessarily mean to cover all categories of tools offered by us. You are kindly reminded to verify carefully when you are placing an order with us if you are actually saving half in comparison with the top major brands.

# VEVOR<sup>®</sup>

## *White Board*

**Model:** A015-2436P

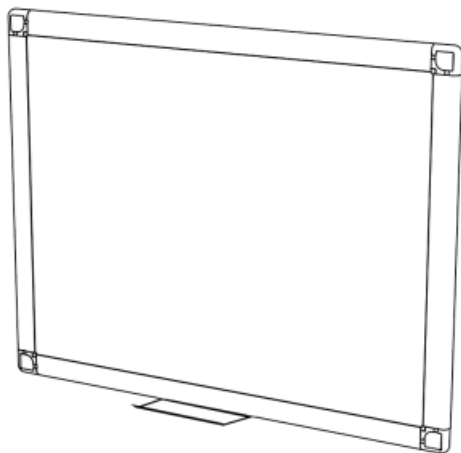

### **NEED HELP? CONTACT US!**

Have product questions? Need technical support? Please feel free to contact us:



**CustomerService@vevor.com**

This is the original instruction, please read all manual instructions carefully before operating. VEVOR reserves a clear interpretation of our user manual. The appearance of the product shall be subject to the product you received. Please forgive us that we won't inform you again if there are any technology or software updates on our product.

# PRODUCT PARAMETERS

Model	A015-2436P
Installation	Fixed to the wall OR Hang
Product Size	915*610*50mm
N.W.	2.1kg
G.W.	3.4kg

## WARNING:

Read this manual before using this product. Failure to do so can result in serious injury. SAVE THIS MANUAL

## ASSEMBLY PRECAUTIONS

1. Assemble needs to follow these instructions. Incorrect assembly can be a hazard.
2. Wear safety goggles and heavy-duty work gloves during assembly.
3. Do not assemble when tired or when under the influence of alcohol, drugs or medication.
4. Weight capacity and other product capabilities apply to a properly and completely assembled product only.
5. Keep the assembly area clean and well-lit.
6. Keep bystanders out of the area during assembly.
7. Assemble on a flat, level, hard and smooth surface capable of safely supporting a fully loaded cooler cart.

## USE PRECAUTIONS

### WARNING: TO PREVENT SERIOUS INJURY AND DEATH FROM TIPPING:

Write down some words, wait to dry (15 seconds or so), and then wipe. When wiping, must use supporting tools, strength to wipe the surface of the board shall prevail.

2. The written words on the day should be wiped clean.
3. Clean the tool with water when it is dirty, and then continue to use it after it is dry.
4. Do not use hard objects to knock, hit, scratch the writing board, to







ensure normal writing.

5. Use as intended only. Do not sit or stand on the product.

6. Inspect before every use. Do not use it if parts are loose or damaged.

7. Use on flat, level, and hard surfaces only.

## PARTS LIST

 <b>A</b>	<b>4PCS</b>
 <b>B</b>	<b>4PCS</b>
 <b>C</b>	<b>4PCS</b>
 <b>D</b>	<b>1PC</b>
 <b>E</b>	<b>2PCS</b>
 <b>F</b>	<b>6PCS</b>
 <b>G</b>	<b>1PC</b>

# ASSEMBLY STEPS

Thanks for purchasing one of our products, please read the assembly steps carefully before installation

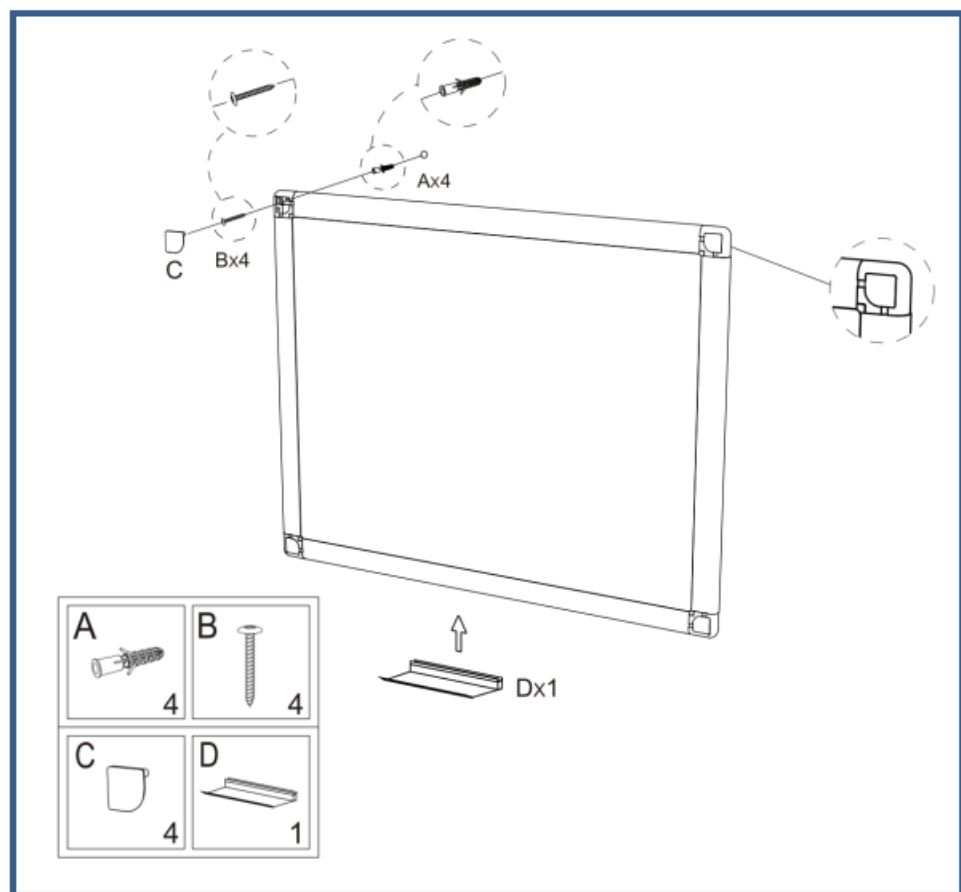

**Importer: WAITCHX**

**Address: 250 bis boulevard Saint-Germain 75007**

**Paris**

**Importer: FREE MOOD LTD**

**Address: 2 Holywell Lane, London, England, EC2A**

**3ET**



**EUREP UK LTD**

**UNIT 2264, 100 OCK STREET, ABINGDON**

**OXFORDSHIRE ENGLAND OX14 5DH**



**EUREP GmbH**

**Unterlettenweg 1a, 85051**

**Ingolstadt, Germany**

**Manufacturers: QINGDAO BRANDLAND**

**INTERNATIONAL CO., LTD.**

**Address:6th floor B3#,Hisense Powerise valley ,**

**No.20 Zhuzhou Road, Qingdao 266061 China**

**Made in China**

**VEVOR<sup>®</sup>**

**TOUGH TOOLS, HALF PRICE**

**Support and E-Warranty Certificate <https://www.vevor.com/support>**