

# **VEVOR<sup>®</sup>**

**TOUGH TOOLS, HALF PRICE**

Support and E-Warranty Certificate [www.vevor.com/support](http://www.vevor.com/support)

## **MULTI-FUNCTION VEGETABLE CUTTER INSTRUCTION MANUAL**

We continue to be committed to provide you tools with competitive price.

"Save Half", "Half Price" or any other similar expressions used by us only represents an estimate of savings you might benefit from buying certain tools with us compared to the major top brands and does not necessarily mean to cover all categories of tools offered by us. You are kindly reminded to verify carefully when you are placing an order with us if you are actually saving half in comparison with the top major brands.

# VEVOR®

TOUGH TOOLS, HALF PRICE

**MULTI-FUNCTION  
VEGETABLE CUTTER**

**MODEL:**QTJ-J002 QTJ-J002X QTJ-J002XE QTJ-J002XF

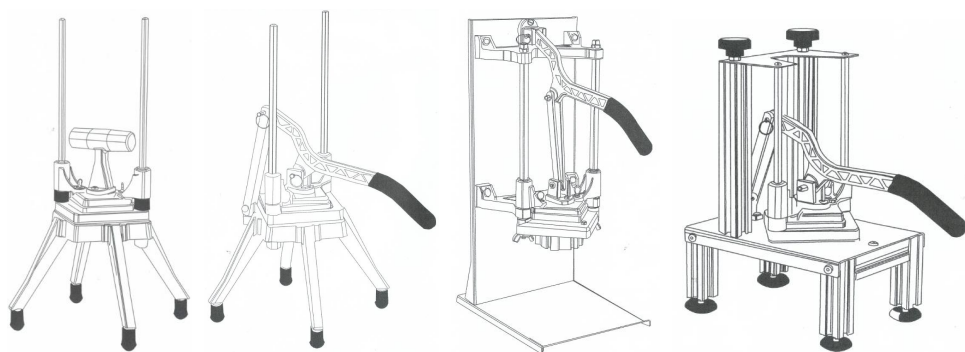

## NEED HELP? CONTACT US!

Have product questions? Need technical support? Please feel free to contact us:

 [CustomerService@vevor.com](mailto:CustomerService@vevor.com)

This is the original instruction, please read all manual instructions carefully before operating. VEVOR reserves a clear interpretation of our user manual. The appearance of the product shall be subject to the product you received. Please forgive us that we won't inform you again if there are any technology or software updates on our product.



Before operating this device, please read this instruction manual completely and keep it handy for future reference.

## **Important Assurance**

Always follow basic safety precautions when using these devices. These include:

- 1.The device should not be used with children. There are very sharp blades on the device. Children may encounter injury accidents. Therefore, this product should be placed in a position not touched by children.
- 2.For optimal operation and service life of the device, please follow the instructions.
- 3.Food acids will make blades dull and corrode the metal. Always clean this food preparation equipment immediately after every use.To maintain the appearance and increase the service life,clean it daily.
- 4.The machine blades are very sharp, and care should be taken not to touch the banging blade or blade directly or to operate with gloves during operation.
- 5.Do not put these devices in a dishwasher or other automatic cleaning device for cleaning.
- 6.The use of accessories or modifications not provided by the manufacturer may cause hazards.
- 7.Only use this equipment for cutting fruits and vegetables!
- 8.Before using this equipment for the first time, please remove all packaging and fixing materials according to the illustration and use them after installation.
- 9.These devices require regular lubrication. Wipe the guide rod with mineral oil,food-grade lubricant, or a towel when lubrication is needed. Do not lubricate with cooking oil or another grease. Otherwise, it will become viscous and affect the use.
- 10.Do not cut food beyond the opening of the plate.

11.To the replace blade sets, please ensure that the specification and models of blade plate and pressing block are consistent.



	 <b>WARNING</b>
	Sharp Blade Hazard:Blades are sharp and can cause cuts. To avoid injury from sharp blades,handle with care.

## QTJ-J002

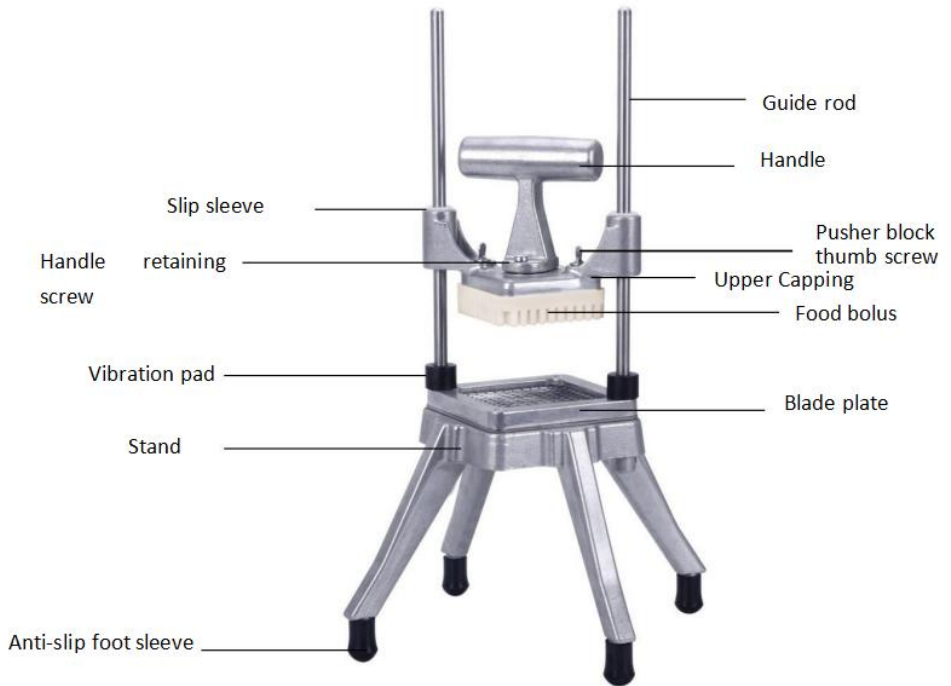

### Schematic Diagram:







**Configuration A:**

	1pc	1/4inch, Installed on the product
	2pcs	
Brush	1pc	
Gloves	1couple	

**Configuration B:**

	1pc	3/8inch, Installed on the product
	2pcs	
Brush	1pc	
Gloves	1couple	

**Configuration C:**

	1pc	1/4inch, Installed on the product
	1pc	1/2inch
	1pc	3/8inch
	6pcs	1/4"*2    1/2"*2    3/8"*2
	1pc	6-valve
Brush	1pc	
Gloves	1couple	
Tray	1pc	

**Operation Guide:**



View QTJ-J002X for operating guidelines.

# QTJ-J002X

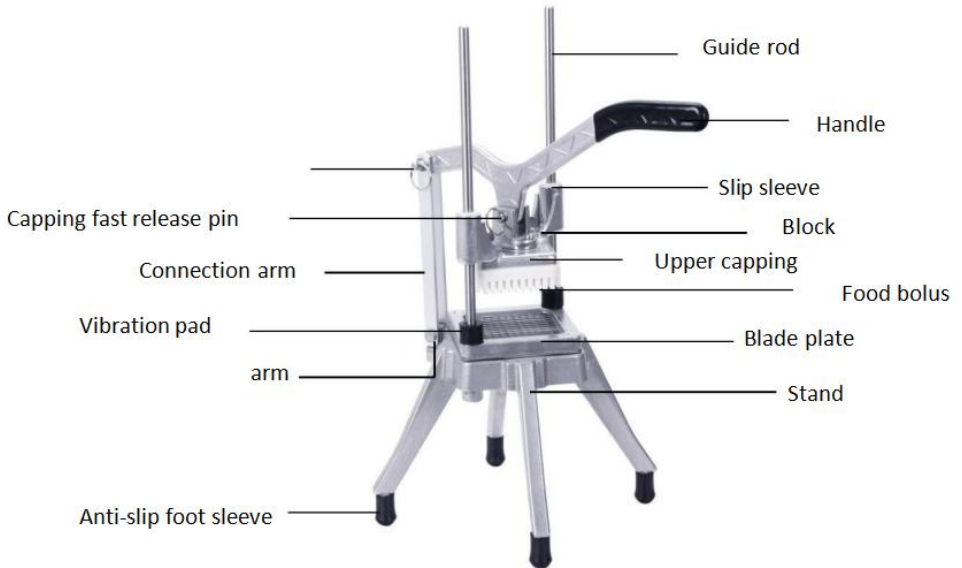

## Schematic Diagram:





## Configuration A:

	1pc	1/4inch, Installed on the product
	2pcs	
Brush	1pc	
Gloves	1couple	





## Configuration B:

	1pc	3/8inch, Installed on the product
	2pcs	
Brush	1pc	
Gloves	1couple	

### Configuration C:

	1pc	1/2inch, Installed on the product
	2pcs	
Brush	1pc	
Gloves	1couple	

### Configuration D:

	1pc	1/4inch, Installed on the product
	1pc	1/2inch
	1pc	3/8inch
	1pc	6-valve pit removal
	6pcs	1/4"*2    1/2"*2    3/8"*2
Brush	1pc	
Gloves	1couple	

### Operation Guide:



1. Open the package, remove the equipment, and remove the fixing material on the package.



2. Place the handle in the corresponding position and insert the fastening pin for fixation, as shown in the figure.

3. After the equipment installation, selecting a flat and solid table is necessary. The height is proportional to the actual height of operator, and it will be better to adopting the height, which ensures that it is relatively easy for press.

4. The equipment blade set is comprised of a blade plate and food-pushing block. When changing the blade set, it is necessary to replace the blade plate and food-pushing block at the same time. The device can be equipped with 4 different striping specifications and cutting block blade sets.

5. Grid blade is selected for cutting: cucumber, radish, potatoes, onion, pepper, fungi, scallion, and other ingredients for stripping and dicing. The food material is cut into strips or small pieces by pressing at initial cutting, and the strips can be cut into buttons by placing them in the blade again for secondary cutting.

6. Pattern blade is selected and can be used for fruit cutting, such as apples, oranges, pears, and other melon and fruit for 6 leaves, 6 leaves and pit removal and other cutting.

7. The size of the food to be cut shall not exceed the cutter's edge so that the food shall be decomposed first.

8. During the operation, place the ingredients in the middle of the blade. The blade is very sharp. Do not allow the hand to touch the blade directly. Put the ingredients in place and quickly remove the hand. Press the handle again. Do not pause during the compression. Press to the end at one time to avoid damage to the blade.

### **Blade Sets Changing:**

1. According to Figure 1, pull out the crimping pin and put the handle upside down.

2. Hold the upper gland with both hands, slide it smoothly and upward from the guide rod, and remove the upper gland. Then, unscrew 2 push block hand screws, remove the food push block, replace the push block with the required specification, and tighten the hand screws.







3. The vibration-damping pad on the guide rod was removed, and the blade plate was removed from the guide rod.

4. Prepare the required blade plate, and in the same way, successively install the blade plate and pressure head (note: the blade mouth is facing upwards).





5. After the completion of the replacement, try to press it first to check whether there is a blade-banging phenomenon and whether the specification of the blade set is consistent.

## QTJ-J002XE

### Schematic Diagram:



## Configuration :

	1pc	6-valve, Installed on the product
	1pc	1/4inch
	1pc	3/8inch
	1pc	6-valve pit removal
	4pcs	1/4"*2    3/8"*2
Brush	1pc	
Gloves	1couple	
Wrench	1pc	

## Operation Guide:

1. Open the package, remove the equipment, and remove the fixing material on the package.

2. Fix the mounting plate with the accessory package screw on the base, as shown in the figure, and tighten the screw.



3. Place the handle in the corresponding position and install the quick-release pin, as shown in the figure.



4. After the completion of equipment installation, select a flat and solid table as necessary. The height is proportional to the actual height of the operator, and it will be better to adopt the height, which ensures that it is relatively easy to press.

5. The equipment blade set composes a blade plate and food-pushing block. When changing the blade set, it is necessary to replace the blade plate and food-pushing block at the same time. The device can be equipped with 4 different striping specifications and blocking blade sets.

6. Grid blade is selected to cut: cucumber, radish, potatoes, onion, pepper, fungi, scallion, and other ingredients for stripping and dicing. The food material is cut into strips or small pieces by pressing at one time, and the

strips can be cut into buttons by placing them in the blade again for secondary cutting.

7. Pattern blade is selected for fruit cutting, such as apples, oranges, pears and other melon and fruit 6 leaves, 6 leaves and pit removal and other cutting.

8. The size of the food to be cut shall not exceed the cutter's edge so that the food shall be decomposed first.



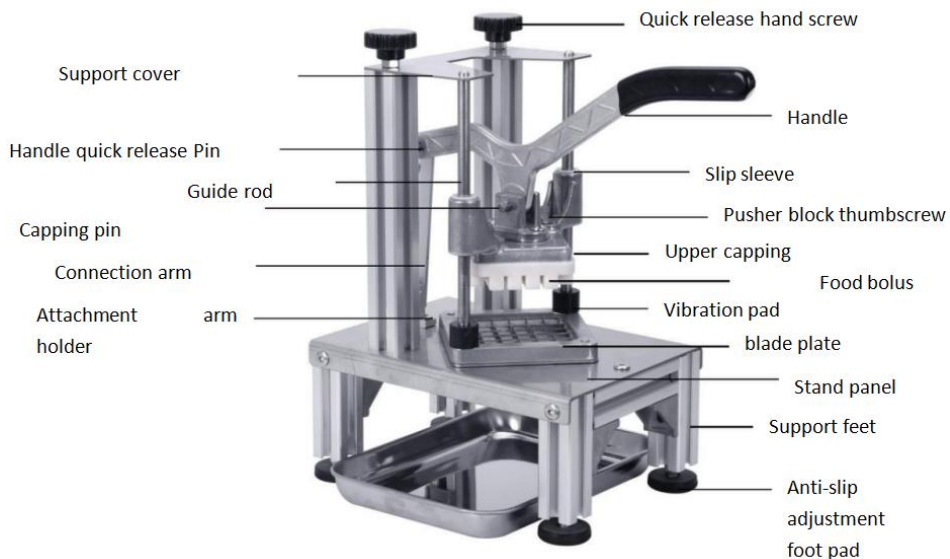

9. During the operation, place the ingredients in the middle of the blade. The blade is very sharp. Do not let the hand directly touch the blade. Put the ingredients in place and quickly remove the hand. Then quickly press the handle. Do not pause during the pressing. Press to the end at one time to avoid damage to the blade.

## QTJ-J002XF

### Schematic Diagram:



### Configuration :

	1pc	1/4inch,Installed on the product
	1pc	3/8inch
	1pc	6-valve
	1pc	6-valve pit removal
	4pcs	1/4"*2    3/8"*2
Brush	1pc	
Gloves	1couple	
Tray	1pc	
Wrench	1pc	

### Operation Guide:



1.Open the package, remove the equipment, and remove the fixing material on the package.



2.Place the flat table as shown, check whether the four feet are flat, and adjust the four anti-slip adjustment foot pads.



3.As shown in the figure,place the handle in the corresponding position and fix it with a quick-release pin.

4.After the equipment installation, selecting a flat and solid table is necessary. The height is proportional to the actual height of operator, and it will be better to adopt the height, which ensures that it is relatively easy to

press.

5.The equipment blade set is composed of a blade plate and food-pushing block. When changing the blade set, it is necessary to replace the blade plate and food-pushing block at the same time. The device can be equipped with 4 different striping specifications and blocking blade sets.

6.Grid blade is selected to cut: cucumber, radish, potatoes, onion, pepper, fungi, scallion, and other ingredients for stripping and dicing. The food material is cut into strips or small pieces by pressing at one time, and the strips can be cut into buttons by placing them in the blade again for secondary cutting.

7.Pattern blade is selected for fruit cutting, such as apples, oranges, pears and other melon and fruit 6 leaves, 6 leaves and pit removal and other cutting.

8.The size of the food to be cut shall not exceed the cutter's edge so that the food shall be decomposed first.

9.During the operation, place the ingredients in the middle of the blade. The blade is very sharp. Do not let the hand directly touch the blade. Put the ingredients in place and quickly remove the hand. Then quickly press the handle. Do not pause during the pressing. Press to the end at one time to avoid damage to the blade.

### **Blade Sets Changing:**



1. As shown in the figure, pull out the compression cover quick-release pin and put the handle backward.



2. According to the figure, the two quick-release thumbscrews were removed, and then the support cover plate was removed.

3. As shown in the figure, slide the upper compression cover smoothly upward from the guide rod, screw out the handle screws of the two pushing

blocks on the upper compression cover, and remove the food pushing block; then load the prepared food pushing block back according to the position and place it aside.



4. According to the figure, the vibration damping pad on the guide rod is removed upwards, and the cutter head is removed upwards in parallel.



5. Prepare the required blade and food-pushing block, and in the same way, successively load back the blade and pressure head and other components, and install the handle (note: the blade jaw is facing up). Check whether there is a blade-banging phenomenon and whether the specification of the blade sets is consistent.

## Clean and Maintenance

1. The whole machine of the equipment can be flushed. After each use, it is necessary to ensure the blade is clean. The clean water can be washed so the blade remains clean and is not corrupted. The service life of the blade is prolonged.

2. The equipment belongs to precision machining machine. Therefore, self-modification and equipment recreation will affect the use, which belongs to artificial damage.

3. The blade belongs to the natural wear part of the equipment. After cutting a certain time and quantity of ingredients, the blade will be broken or worn. It is necessary to timely purchase the blade with the corresponding

specification for replacement (Improper operation or cutting too hard ingredients will also damage the blade).

4.The equipment use an ultra-thin blade and cannot cut tough foods like meat and sweet potatoes.

5.The equipment must be lubricated regularly.

6.If it cannot be pressed when cutting, it indicates that the cutter plate has been worn and changed. Do not press hard. First, remove the cutter plate, replace the corresponding specification's cutter plate, and continue using it.

7.In the operation, it is necessary to ensure that the complete machine is on a flat and firm table. Otherwise, it is easy to slide and hit the blade, affecting the machine's use.

8.Periodically check whether there is a loose set screw, timely tighten the screw, and maintain the machine.

**MADE IN CHINA**

**VEVOR<sup>®</sup>**

**TOUGH TOOLS, HALF PRICE**

**Support and E-Warranty Certificate [www.vevor.com/support](http://www.vevor.com/support)**