

VEVOR[®]

**Electric Bain Marie
Countertop Food Warmer**

BW-16\ BW-16EU\ BW-16AU

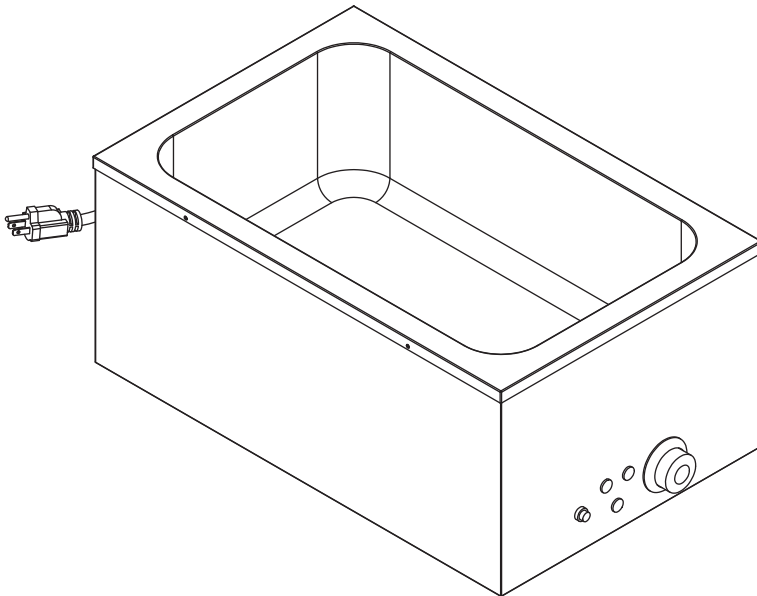

NEED HELP? CONTACT US!





Have product questions? Need technical support? Please feel free to contact us:

 **CustomerService@vevor.com**

This is the original instruction, Please read all manual instructions carefully before operating. VEVOR reserves clear interpretation of our user manual. The appearance of the product shall be subject to the product you received. Please forgive us that we won't inform you again if there is any technology or software updates on our product.

Important Safety Information

Please read the following statements carefully and understand their meaning prior to use to ensure safe operation.

	Warning-To reduce the risk of injury, user must read instructions manual carefully.
	This symbol, placed before a safety comment, indicates a kind of precaution, warning, or danger. Ignoring this warning may lead to an accident. To reduce the risk of injury, fire, or electrocution, please always follow the recommendation shown below.
	HOUSEHOLD USE ONLY
	This product is subject to the provision of European Directive 2012/19/EC. The symbol showing a wheeled bin crossed through indicates that the product requires separate refuse collection in the European Union. This applies to the product and all accessories marked with this symbol. Products marked as such may not be discarded with normal domestic waste, but must be taken to a collection point for recycling electrical and electronic devices.

	CAUTION: In order to avoid a hazard due to inadvertent resetting of the thermal cutout, this appliance must not be supplied through an external switching device, such as a timer, or connected to a circuit that is regularly switched on and off by the utility.
--	---

- Improper installation, adjustment, alteration, service or maintenance can cause property damage, injury or death.
- Read the installation, operating and maintenance instructions thoroughly before installing or servicing this equipment.
- Do not store or use gasoline or other flammable vapors or liquids in the vicinity of this or any other appliance.
- The information contained in this manual is important for the proper installation, use and maintenance of this product.
- Adherence to these procedures and instructions will result in satisfactory results and long-term trouble-free service. Please read this manual carefully and retain it for future reference.
- Do not spray the bain marie with a water hose under pressure. Do not spray liquids directly onto the control panel (refer to the cleaning section for details).
- Do not place any part of your body on bain marie lids when the unit is turned on.
- Do not operate the bain marie next to any heat source or grease emitting appliance (i.e. bain maries).
- Do not use the unit for any other purpose other than holding food.
- Do not use sharp objects to activate controls.
- Do not use sharp objects to activate controls.
- Take extreme care when lifting the bain marie pot lids as steam may be expelled from hot food stuffs. Do not touch the tank element covers or elements when machine is hot.

- Do not let children or minors touch or use this product (Note: This appliance can be used by children aged from 8 years and above and persons with reduced physical, sensory or mental capabilities or lack of experience and knowledge if they have been given supervision or instruction concerning use of the appliance in a safe way and understand the hazards involved. Children shall not play with the appliance. Cleaning and user maintenance shall not be made by children without supervision.)
- Please be careful during use: Do not put non-food items into the product for heating and please use purified water
- Type Y attachment: If the supply cord is damaged, it must be replaced by the manufacturer, its service agent or similarly qualified persons in order to avoid a hazard.

Introduction

The bain marie has been specifically designed to meet the rigorous demands of a busy food service operation. Each bain marie has been assembled and tested according to strict quality standards.

Technical Specifications:

Model No.	Power	Voltage	Dimension(mm)	Plug Type	Dry burning indication
BW-16	1200W	110-120V ~60Hz	625*425*320	NEMA 5-15P	YES
BW-16EU	1200W	220V-240V ~50/60Hz	625*425*320	EU Plug	YES
BW-16AU	1200W	110-120V ~60Hz	625*425*320	AUSTRALIAN Plug	YES

Installation Instructions

Please note this unit must be installed by a qualified person!

A.Unpacking:

1. Remove the bain marie and operation manual from the packaging.
2. Remove all packaging materials and protective layers from the bain marie, including the plastic protective layer on all stainless steel.
3. Wipe all surfaces with a clean, sanitized cloth.
4. Check unit for damage. If the bain marie is damaged, notify your distributor immediately.

Operating Instructions

The unit must be connected to a power point with compatible power rating.

1. The unit is equipped with a heating element. Add adequate water inside the tank.

ATTENTION: check the water level inside the water tank from time to time and make sure that the water level is between “MIN” and “MAX”, especially when selecting high temperature, prevent the heating element from dry burning.

2. Rotating the thermostat knob. Do not use the distiller until the preheat cycle is complete, as you will not achieve optimal product retention.
3. Place the cooked or heated product into the food pan of the gas stove and place into bain marie tank.
4. Cover the pans with correct gas stove lids to suit.
5. Keep close attention to the temperature of the food product. If the product is too hot, it will dry out; if it is too cold, it will deteriorate.

Cleaning

To maintain appearance and extend service life, the bain marie should be cleaned at least daily.

1. Before cleaning or moving, unplug the unit and let it cool completely.
2. Carefully empty the water from the well.
3. Wipe the entire well interior with a clean, damp cloth.
4. To avoid damaging the well finish, do not use abrasive materials, scratching cleansers or scouring pads to clean water deposits from well.
5. If soap or chemical cleaners are used, be sure to rinse them off completely with water immediately after cleaning.

Chemical residue could damage warmer.

6. Every two hours, remove pan and check the water level.

DO NOT IMMERSE BAIN MARIE IN WATER OR OTHER LIQUID.

DO NOT SPRAY WITH WATER OR CLEANING PRODUCT. LIQUID COULD ENTER THE ELECTRICAL COMPARTMENT AND CAUSE A SHORT CIRCUIT OR ELECTRIC SHOCK.

Wiring Diagram

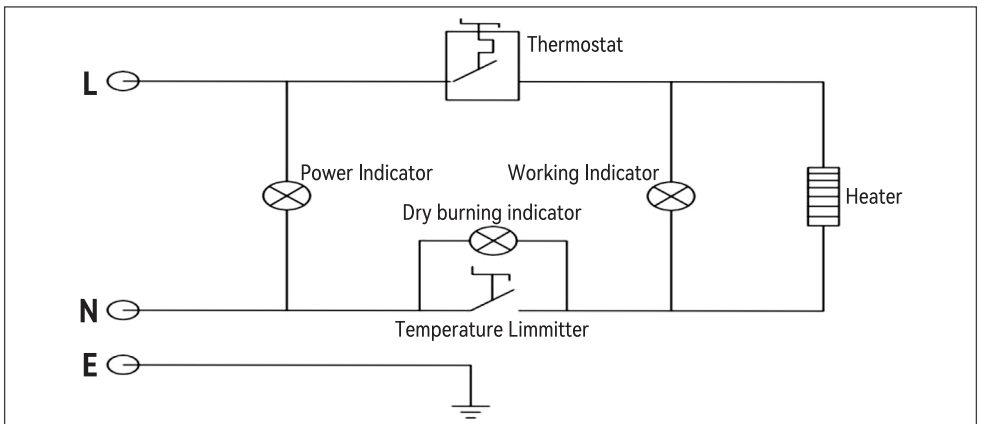

Trouble Shooting Chart

If a problem occurs that does not appear on this table, stop using the bain marie and seek help from the manufacturer, a qualified technician or an authorized dealer.

Temperature safety reset switch

The unit is equipped with a switch that cuts off power if there is not enough water in the tank to cover the heating element. This switch has a manual reset. The reset switch and cover is usually located on the front panel of the unit. Determine what caused the safety switch to activate and correct it. Possible causes include: dirty water, low water level and element not properly submerged in water.

To reset the temperature safety switch, follow the 4 steps below:

1. Wait until the oil has cooled to 120°F (50°C) or below.
2. Remove the switch cover by unscrewing the cover counterclockwise.
3. Use a pen or similar narrow tool and press the reset button down. The button should stay in the down or in the set position.
4. Put the switch cover back in place and tighten it clockwise to fix it.

Other Possible Shooting Chart

Issue	Potential Cause	Solution
Unit is too hot	Temperature control is set too high	Change the temperature to a lower setting
	Unit is connected to incorrect power supply	Contact an authorized electrician
	Defective internal thermostat	Contact an authorized electrician
Unit is not hot enough	Unit has not had enough time to preheat	Allow unit 30 minutes to reach operating temperature. This can be accelerated by closing the drawer vent(s).
	Temperature control is set too low	Change the temperature to a higher setting
	Defective internal thermostat	Contact an authorized electrician
	Water level is low	Fill well with warm/hot water up to "MAX" fill line
Unit is not working at all	Unit is not plugged in	Plug unit into proper power supply
	Unit is not turned on	Press the On/Off switch on the digital control
	Circuit breaker tripped	Reset circuit breaker
	Control knob is defective	Contact an authorized electrician
	Heating element is burned out	Contact an authorized electrician

Manufacturer: Guangzhou Crosson Kitchen Equipment Co., Ltd.

Address: Room 101, Dongsheng Road, Chadong Village, Panyu District, Guangzhou, Guangdong Province, China

UK Importer: FREE MOOD LTD

Address: 2 Holywell Lane, London, England, EC2A 3ET

UK	REP	EUREP UK LTD UNIT 2264, 100 OCK STREET, ABINGDON OXFORDSHIRE ENGLAND OX14 5DH
-----------	------------	---

EC Importer: WAITCHX

Address: 250 bis boulevard Saint-Germain 75007 Paris

EC	REP	EUREP GmbH Unterlettenweg 1a, 85051 Ingolstadt, Germany
-----------	------------	---

VEVOR[®]

E-mail: CustomerService@vevor.com