

VEVOR[®]

TOUGH TOOLS, HALF PRICE

Technical Support and E-Warranty Certificate

<https://www.vevor.com/support>

SAWMILL GUIDE RAIL

USER MANUAL

We continue to be committed to offering tools at competitive prices. "Save Half", "Half Price", or any other similar expressions used by us only represent an estimate of savings you might benefit from buying certain tools with us compared to the major top brands and do not necessarily mean to cover all categories of tools offered by us. You are kindly reminded to verify carefully when placing an order with us if you are saving half in comparison with the top major brands.

VEVOR[®]

SAWMILL GUIDE RAIL (9FT)



NEED HELP? CONTACT US!









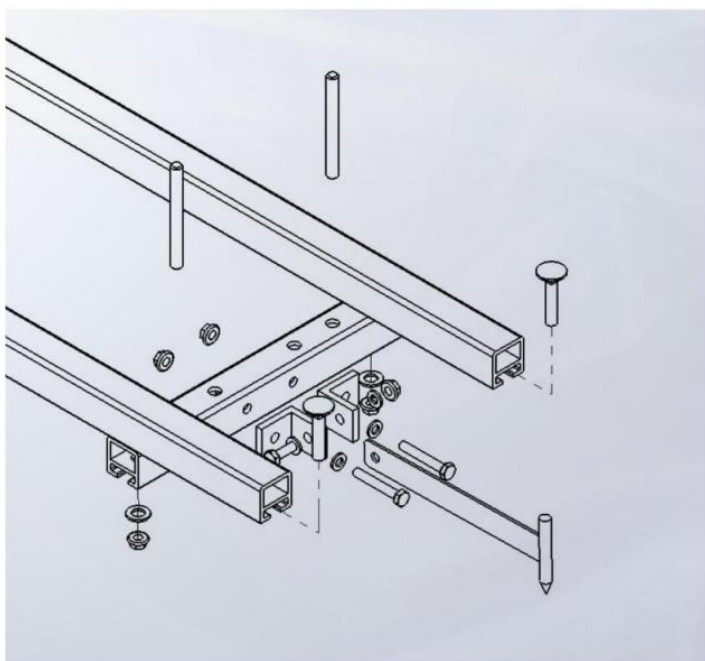
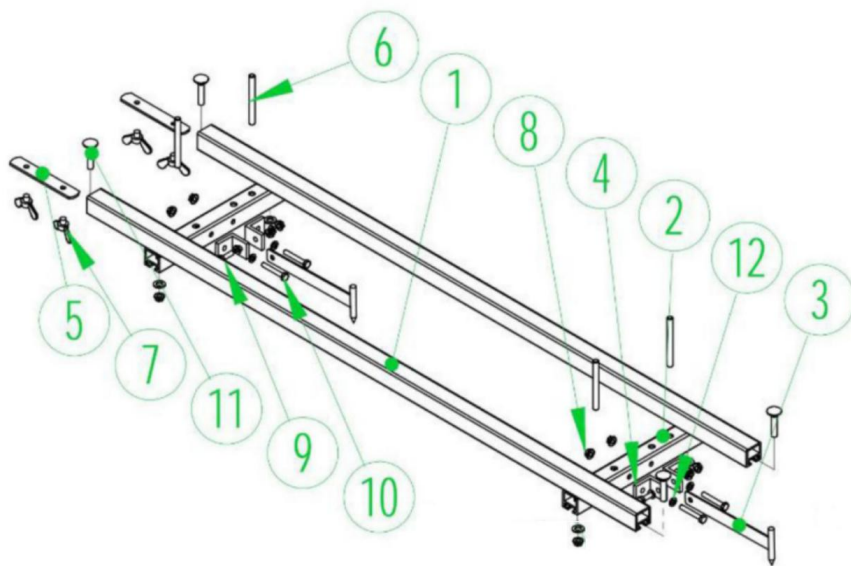







Have product questions? Need technical support? Please feel free to contact us:

 CustomerService@vevor.com

This is the original instruction, please read all manual instructions carefully before operating. VEVOR reserves a clear interpretation of our user manual. The appearance of the product shall be subject to the product you received. Please forgive us that we won't inform you again if there are any technology or software updates on our product.

Drawing and parts list



NO	QTY	PIC	DISCRIPTION
1	6		Side rail
2	4		Cross bar
3	4		Dog
4	8		Dog hinge plate
5	4		Connect bar
6	8		Leveling screw
7	4		Butterfly screw
8	12		Small nut
9	4		Cross blot
10	8		Long blot
11	8		Carriage blot
12	24		Small washer
13	1		Allen wrench
14	2		Wrench
15	1		Toolkit
16	1		User manual

Assembling Instruction

1. Unpack the rail-kit and lay out all parts, put the same parts together for selecting.
2. Attach both dog hinges plates (No.4) to cross bar (No.2), with bolts washers and nuts (No.10,12 and 8). Do not tighten until dog is attached.



3. Attach dog (No.3) to hinge plates (No.4) with bolt, washers and nut (No.9,12 and 8). Tighten all bolts.



4. Assemble carriage bolts (No.11), nuts and washer (No.12) through cross bar (No.2) leave loose. Head of carriage bolt must be as shown.



5. Install leveling screws (No.6) into cross bar (No.2) slotted end of screw is in the same direction as the head of the carriage bolts.

6. Repeat for all cross bar kits.

7. Slid carriage bolts in cross bar into rails. Do not tighten until you set up the EZ-RAILS on the log. Dog orientation can be in either direction.

8. Once cross bars are located on log, tighten carriage bolts.

9. To extend the rail to longer version, please use 2 of the connect bar (No.5) and each end fastened with a butterfly screw (No.7).



Manufacturer: Yongkang jinjian hardware factory

Address: 11 Huabao Road, Zhiying Industrial Zone II, Yongkang City,
Zhejiang Province, China

VEVOR[®]

TOUGH TOOLS, HALF PRICE

Technical Support and E-Warranty Certificate

<https://www.vevor.com/support>