

VEVOR[®]

TOUGH TOOLS, HALF PRICE

Technical Support and E-Warranty Certificate www.vevor.com/support

TRAILER COUPLER

MODEL: 1BJY-TC-12BS / 1BJY-CK-03

We continue to be committed to provide you tools with competitive price.

"Save Half", "Half Price" or any other similar expressions used by us only represents an estimate of savings you might benefit from buying certain tools with us compared to the major top brands and does not necessarily mean to cover all categories of tools offered by us. You are kindly reminded to verify carefully when you are placing an order with us if you are actually saving half in comparison with the top major brands.

VEVOR[®]

TOUGH TOOLS, HALF PRICE

TRAILER COUPLER

MODEL: 1BJY-TC-12BS / 1BJY-CK-03



NEED HELP? CONTACT US!

Have product questions? Need technical support? Please feel free to contact us:

TechnicalSupport and E-Warranty Certificate

www.vevor.com/support

This is the original instruction, please read all manual instructions carefully before operating. VEVOR reserves a clear interpretation of our user manual. The appearance of the product shall be subject to the product you received. Please forgive us that we won't inform you again if there are any technology or software updates on our product.

SAFETY INSTRUCTIONS

⚠️ WARNING

1. Safety chains must be used.
2. Be sure to take good protection during welding work.
3. Be sure to check that the bolts are tight.
4. Be sure to match the corresponding trailer ball.
5. After towing for 50 miles, check coupler for tightness on ball. Always check tightness before towing. Be sure coupler handle is in locked position.
6. Do not exceed the gross trailer weight capacity.

MODEL AND PARAMETERS





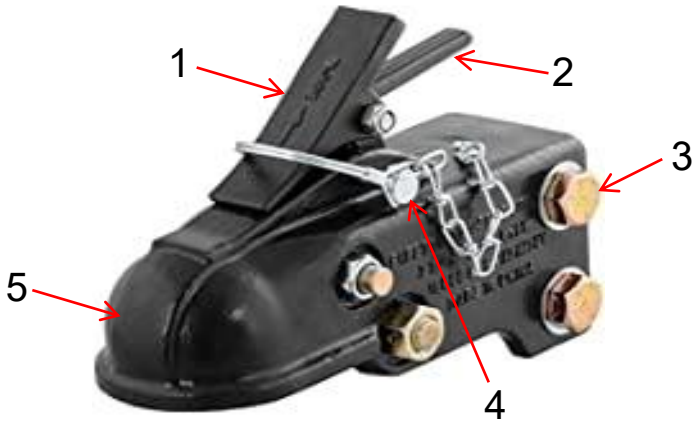

Model	1BJY-TC-12BS	1BJY-CK-03
Capacity	15000lbs	15000lbs
Ball Size	2-5/16inch	2-5/16inch
Applicable Channel	3inch	3inch
Color	Black	Black
Remarks	/	With 5-Position Adjustable Channel Bracket

STRUCTURE DIAGRAM



1.Fastener 2.Handle 3.Connecting Bolt 4.Safety Pin 5.Ball Socket

COMPONENTS

No.	Picture	Name	Qty
1		Trailer Coupler	1
2		Bolt	2
3		Lock Nut	2
4		Shim	4
5		Channel Bracket(Only 1BJY-CK-03)	1
6		User Manual	1

OPERATION

A. Channel Bracket ("1BJY-TC-12BS" does not include the component.)

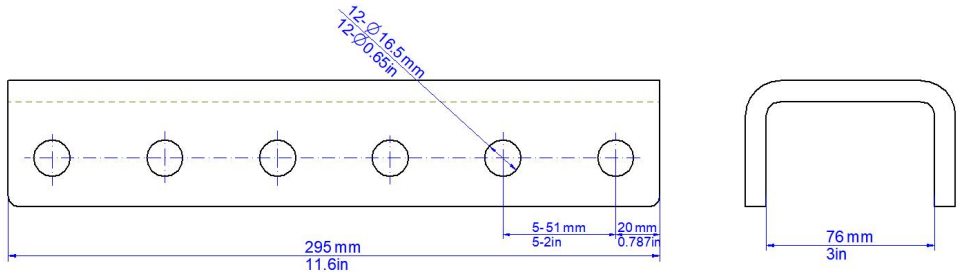

NOTE: The welding must be firm and reliable.

B. Coupler

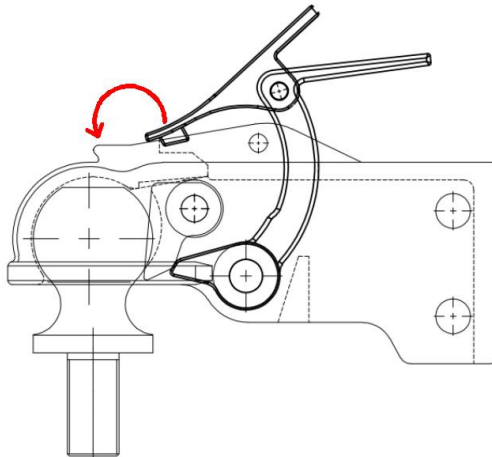

To open, pull up on coupler handle and rotate forward. Place coupler on ball. When ball is completely nested in ball socket, rotate coupler handle backward until handle is in locked position. Plug in the safety latch. After towing for 50 miles, check coupler for tightness on ball. Always check tightness before towing. Be sure coupler handle is in locked position.

MAINTENANCE

1. Please check that the bolts are tight before each use.
2. Do not overload.
3. Pay attention to rust prevention.

MADE IN CHINA

VEVOR[®]

TOUGH TOOLS, HALF PRICE

TechnicalSupport and E-Warranty Certificate

www.vevor.com/support